

TEM

On | Off and everything in between



2023

MODUL



MODUL
LINE



MODUL
SOFT



MODUL
PURE

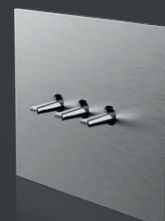

MODUL
EDGE

50

LOGIQ



162

ekonomik



192

fontana



230



TEM

On | Off and everything in between



Ne jemi prodhuesi kryesor i çelësave dhe i prizave në rajon. Për gjysmë shekulli, u kemi ofruar përdoruesve tanë një përvojë pozitive dhe të lehtë, instalim dhe përdorim të thjeshtë të produkteve, një gamë të gjerë ngjyrash dhe materialesh, të cilat bindin edhe më personat më kërkuës.

We are the leading manufacturer of switches and sockets in the region. For half a century, we have been providing our users a positive and easy experience, simple installation and use of products, a wide range of colours and materials, which convince even the most demanding.

TEM

Mirë se vini në familjen MODUL

Welcome to the MODUL family

Jepini ambientit tuaj një ndjesi personale dhe tregoni stilin tuaj me çelësat dhe prizat e familjes MODUL.

Give your ambience a personal touch and show off your style with switches and sockets from MODUL family.

zbulojmë ide të reja

discovering new insights



MODUL

LINE



MODUL

SOFT



MODUL

PURE



MODUL

EDGE

1

2

MODUL

LINE



MODUL

SOFT



MODUL

PURE



3

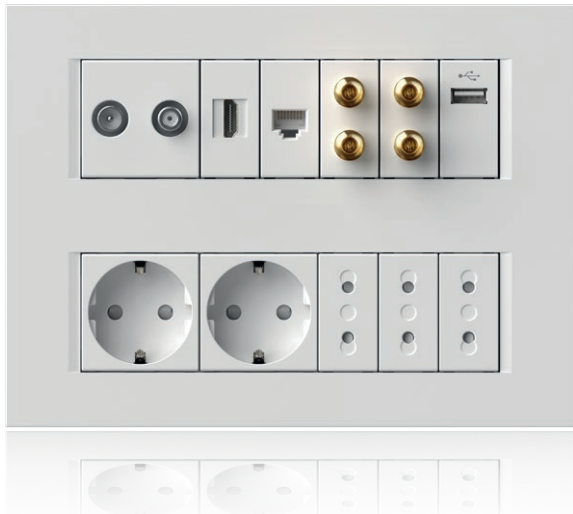

4

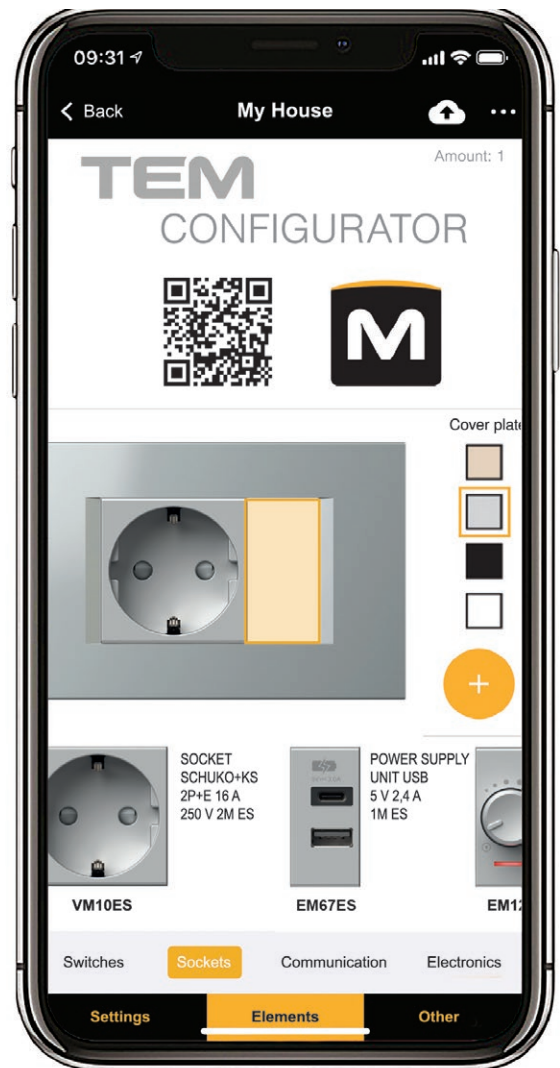

MODUL

LINE



Linjat e drejta dhe të lëmuara krijojnë një dizajn klasik.

Straight, smooth lines create a timeless design.





MODUL

LINE

PW



e bardhë
polare
polar white

MW



e bardhë
mat
matte white

IW



e bardhë
fildishi
ivory white

ES



e argjendtë
elox
elox silver

AT



antracit
anthracite

SB

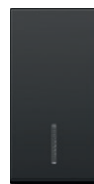

e zezë soft
touch
*soft touch
black*

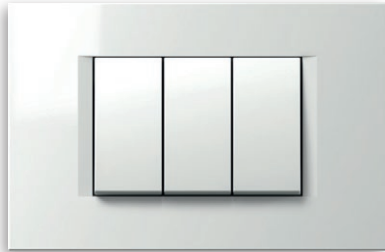

PW e bardhë polare
polar white

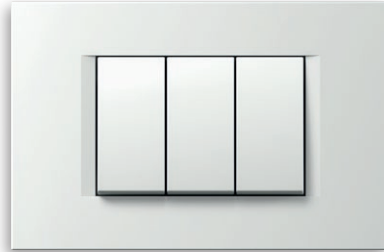

MW e bardhë mat
matte white

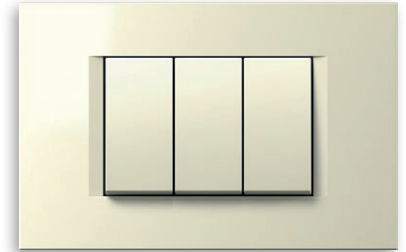

IW e bardhë fildishi
ivory white



SW e bardhë guri
stone white

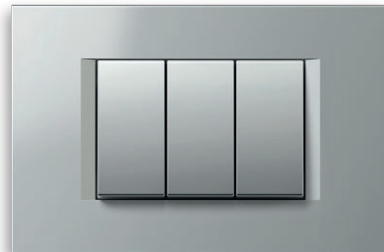

ES e argjendtë elox
elox silver

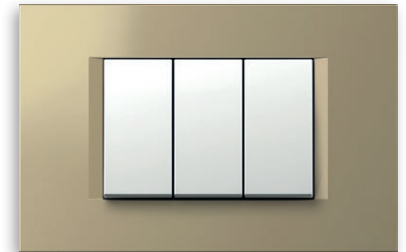

SG e artë ranore
sand gold



TI titan
titanium

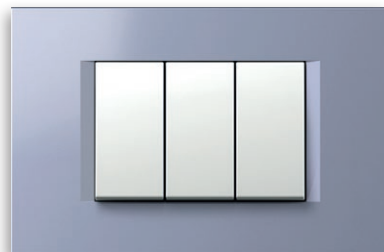

IB blu impulse
impulse blue



AT antracit
anthracite



NB e zezë nate
night black



SB e zezë soft touch
soft touch black

MODUL

SOFT

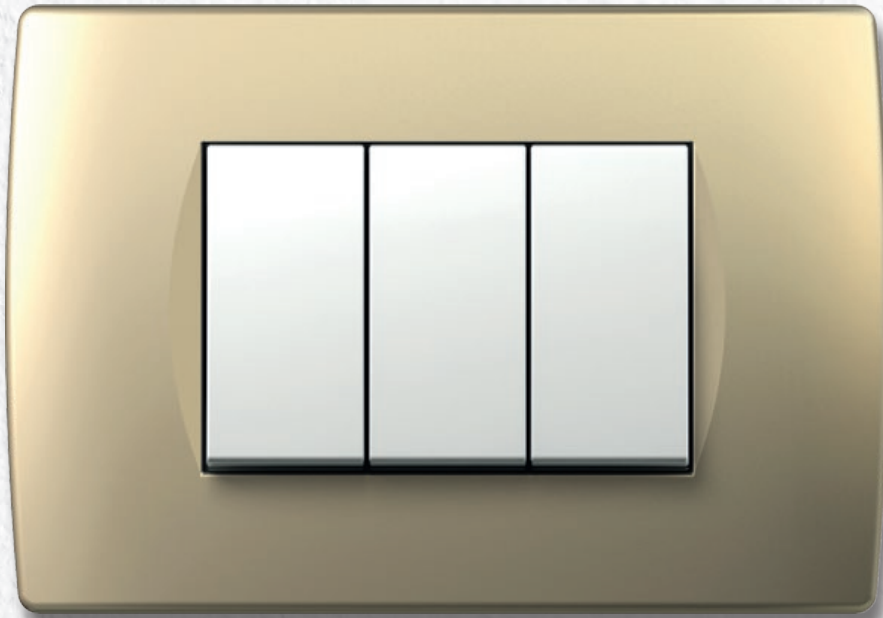

Format e rrumbullakëta dhe pjesët bashkuese të lëmuara sjellin butësi në shtëpinë tuaj.

Rounded shapes and soft transitions bring softness into your home.





MODUL

SOFT

PW



e bardhë
polare
polar white

MW

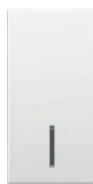

e bardhë
mat
matte white

IW



e bardhë
fildishi
ivory white

ES



e argjendtë
elox
elox silver

AT



antracit
anthracite

SB



e zezë soft
touch
*soft touch
black*

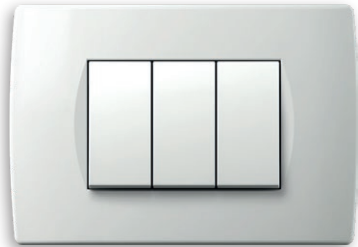

PW e bardhë polare
polar white

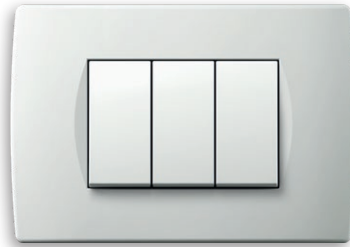

MW e bardhë mat
matte white

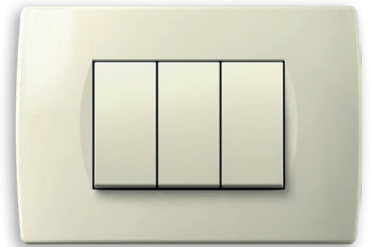

IW e bardhë fildishi
ivory white



ES e argjendtë elox
elox silver

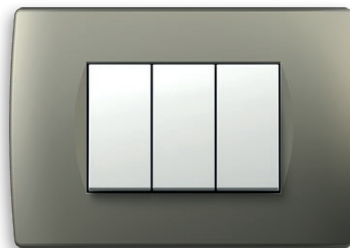

TI titan
titanium

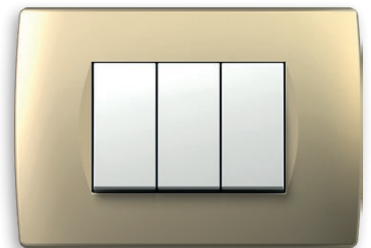

SG e artë ranore
sand gold



WW arrë
walnut



WE venge
wenge



AT antracit
anthracite



NB e zezë nate
night black



SB e zezë soft touch
soft touch black

MODUL

PURE



Detajet përfaqësojnë plotësimin e të gjithë ambientit tuaj. Lëreni natyrën të pasurojë hapësirën tuaj me kapakë mbulues dekorativë prej druri, xhami dhe metali.

The details represent the completeness of the entire ambience. Let the nature enrich your space with decorative cover plates made of wood, glass and metal.





MODUL

PURE

PW	MW	IW	ES	AT	SB
					
e bardhë polare	e bardhë mat	e bardhë fildishi	e argjendtë elox	antracit	e zezë soft touch
<i>polar white</i>	<i>matte white</i>	<i>ivory white</i>	<i>elox silver</i>	<i>anthracite</i>	<i>soft touch black</i>

xham
glass



GL e bardhë
glass light

metal
metal



MH çelik i farkëtuar
hammered steel

dru
wood



WM panjë
maple

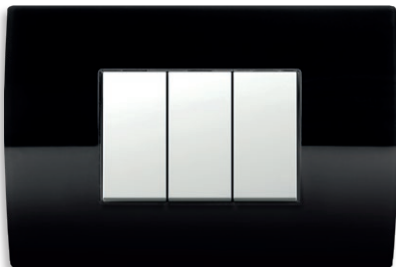

GD e zezë
glass dark

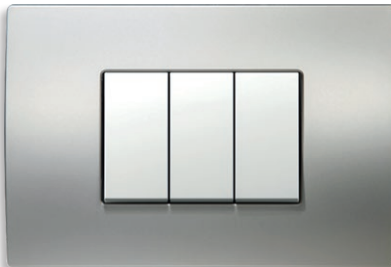

MS argjend satin
satin silver



WB bambu
bamboo



MN nikel satin
satin nickel



WW arrë
walnut



ME hekur i gdhendur
etched iron



WE wenge
wenge

MODUL

PURE



XHAM - i lehtë dhe i sofistikuar.
Lëreni freskinë të fryjë si fllad nëpër të gjithë shtëpinë
tuaj.

*GLASS - light and sophisticated.
Let freshness breeze through your home.*





xham
glass

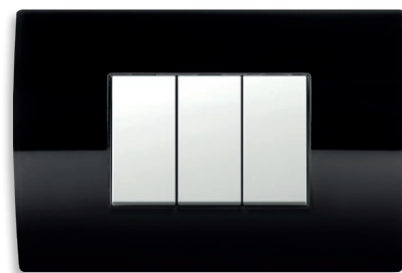

MODUL

PURE



METAL - i ftohtë, por fisnik.
Përvetësojeni këtë material të dëlirë dhe
tërhiqni vëmendjen e të tjerëve lehtësisht.

*METAL - cold, yet noble.
Embrace this pristine material and
effortlessly catch attention.*





metal
metal

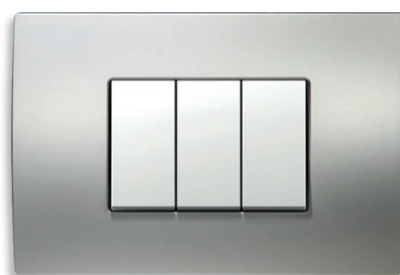

MODUL

PURE



DRURI - i gjithanshëm, por gjithsesi unik.
Pranoni ngrohtësinë e natyrës.

*WOOD - versatile, yet unique.
Give way to nature's warmth.*





dru
wood

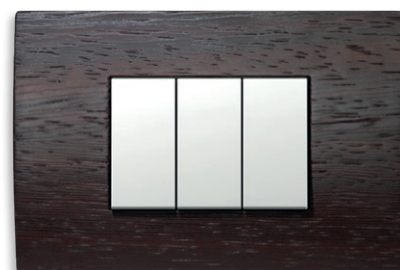

MODUL

EDGE

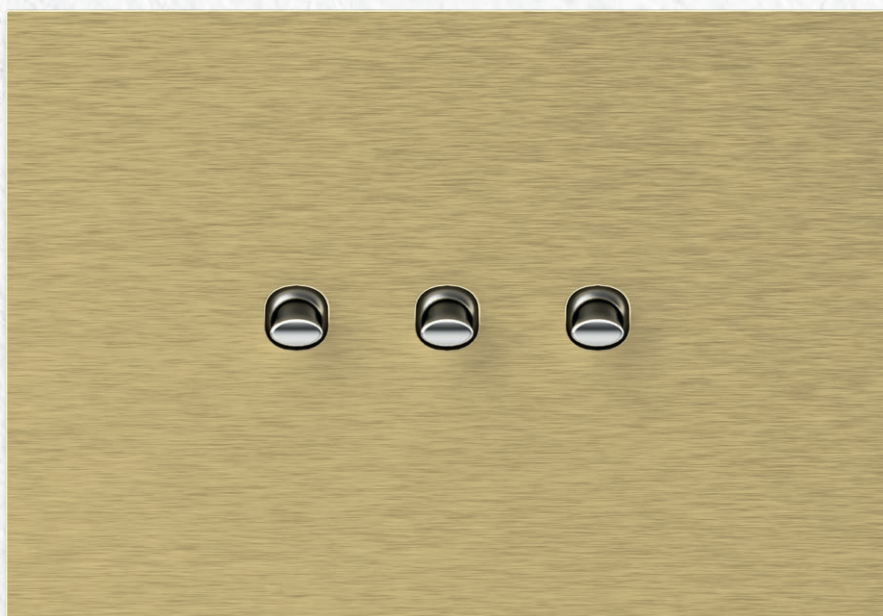

Linja e re prestigjioze e produkteve ofron një përvojë
të veçantë ndijore dhe vizuale si asnjë tjetër më parë.
A jeni aq të guximshëm?

*The new prestigious product line offers a special sensory and visual
experience like no other before. Are you bold enough?*





MODUL

EDGE

PB



e zezë

black

PA



antracit

anthracite

PG



e artë

gold

PC



Krom

chrome

metal
metal

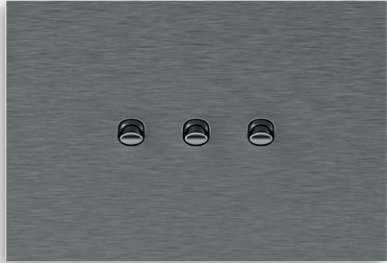

MA e argjendtë
silver

xham
glass



GL e bardhë
glass light

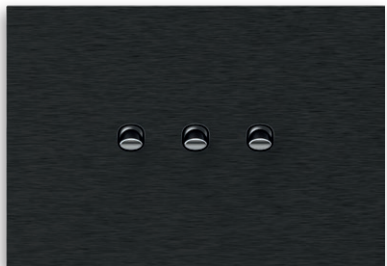

MT antracit
anthracite



GD e zezë
glass dark

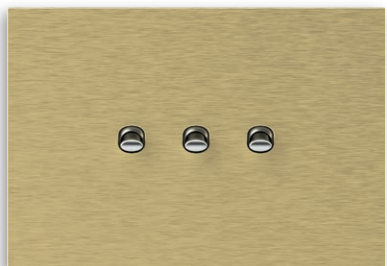

MZ e artë
gold

MODUL
EDGE



Pastërtia e xhamit lejon dritën që të manifestohet në mënyrë lozonjare në kapakët mbulues dekorativë të rinj EDGE. Dy ngjyra kontrasti kënaqin edhe shijet më të sofistikuara.

The purity of the glass allows the light to playfully manifest in the new EDGE glass decorative cover plates. The two contrast colours satisfy even the most sophisticated taste.



xham
glass



GL e bardhë
glass light



GD e zezë
glass dark

MODUL
EDGE



Falë trajtimit impresionues, alumini shkëlqen me një dritë të re – kapakët mbulues dekorativë metalikë EDGE. Tre ngjyrat vlejné të tërheqin vëmendjen tuaj.

Thanks to the impressive treatment, the aluminium shines with a new light – EDGE metal decorative cover plates. The three colours are worthy of your attention.





metal
metal

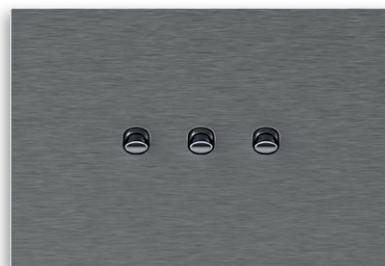

MA e argjendtë
silver



MT antracit
anthracite

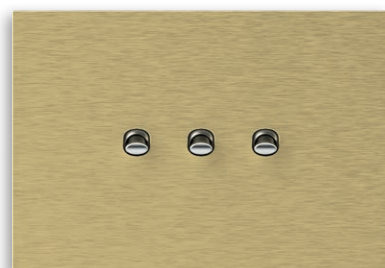

MZ e artë
gold

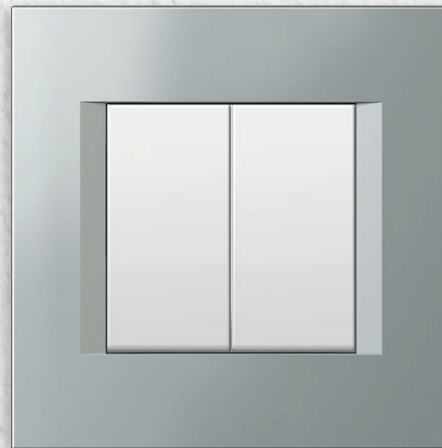

MODUL

- LINE
- SOFT
- PURE
- EDGE

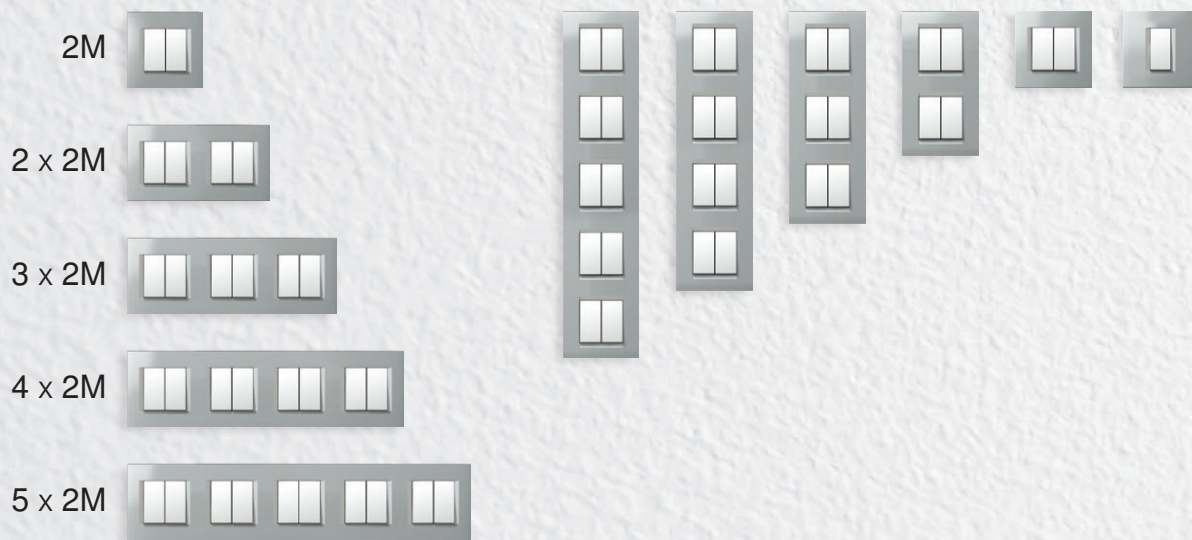
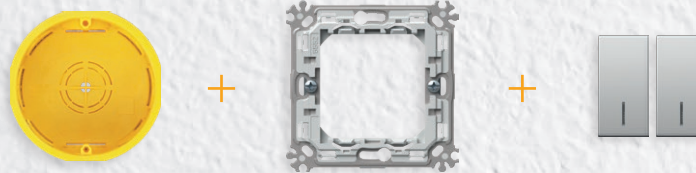

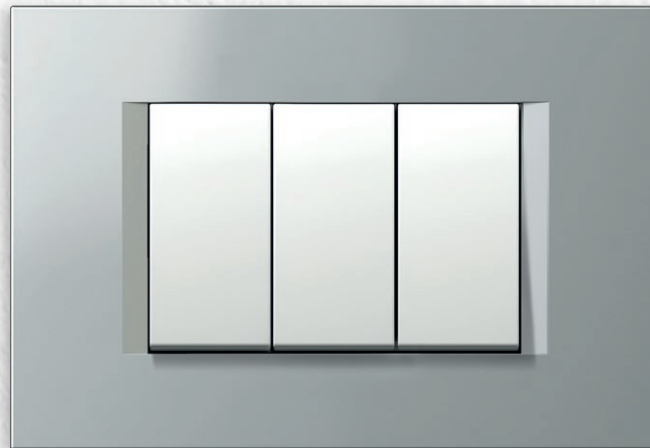

MODUL

- LINE
- SOFT
- PURE
- EDGE



2 x 7M

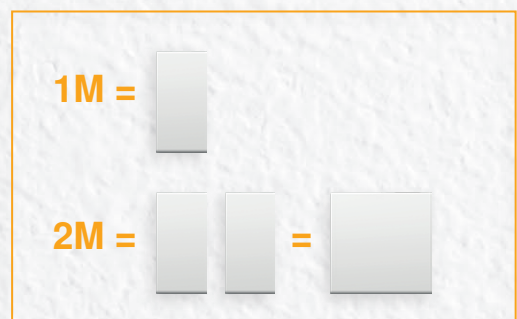
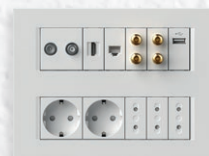

Elementet e funksionit futen lehtë brenda kornizës së montimit. Zgjidhja me “futje dhe nxjerrje në çast” që kemi zhvilluar për ju do t’ju reduktojë kohën e instalimit. Kontaktet e lidhjes arrihen lehtë nga pjesa e përparme.

The function elements are easily fitted inside the mounting frame.

The “klik-in, klik-out” solution we have developed for you will reduce installation time. The connection contacts are easily accessible from the front.

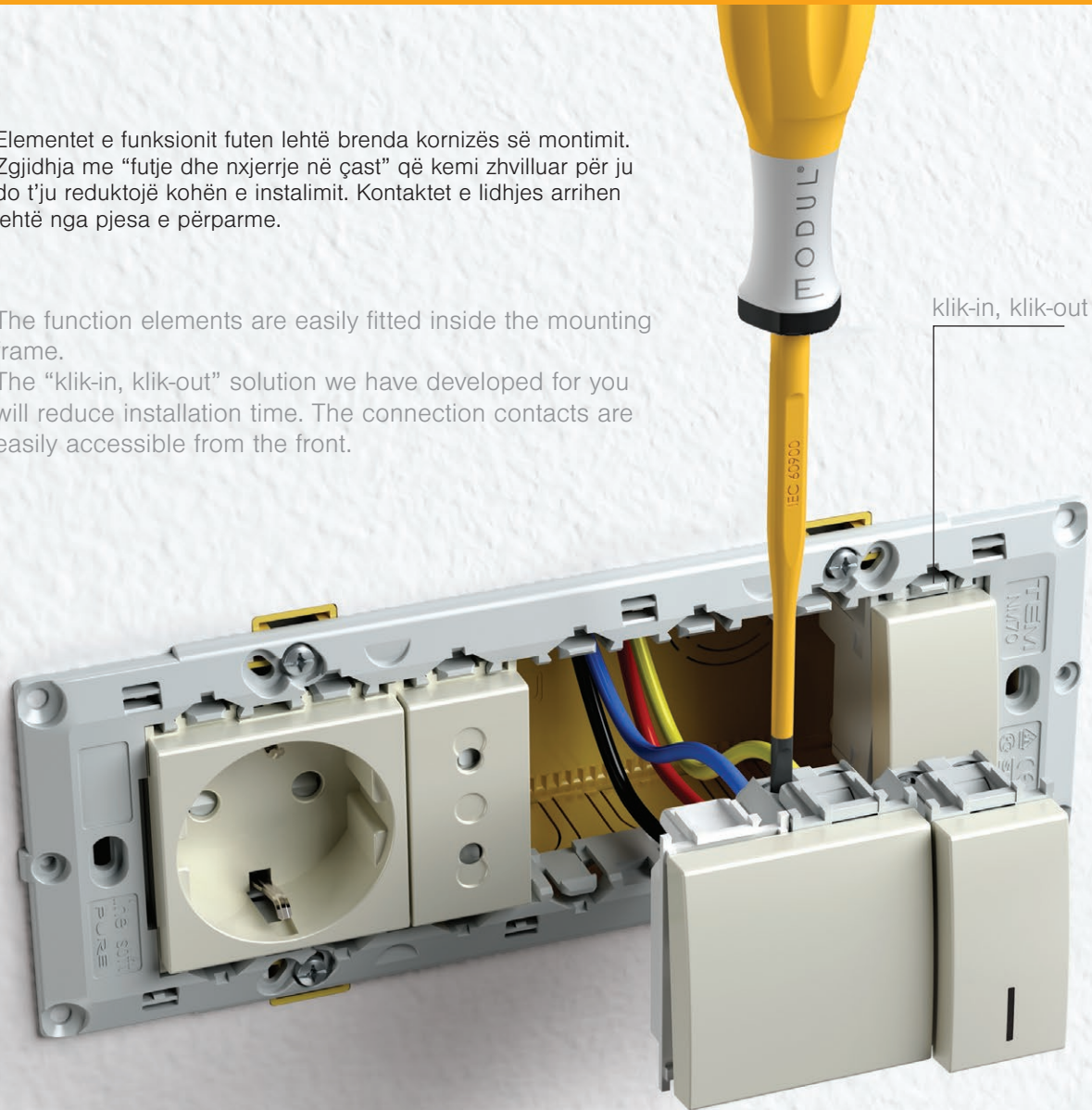

Modul është i përshtatshëm për të gjitha llojet e mureve dhe mund të përdoret në mure me konstruksione tradicionale, boshe ose betoni. Instalohet me lehtësi dhe ju jep mundësinë të kombinoni kutitë drejtkëndore ose të rrumbullakëta në distancat e duhura. Materialet e përdorura janë në pajtim me standardet më të larta.

The Modul is suitable for all wall types and can be used in conventional, hollow wall or concrete constructions. It is easy to install and enables you to combine rectangular or round boxes at the proper distances. The materials used are compliant with high standards.



tullë / brick



mur bosh / hollow wall



beton / concrete

Modul ofron mundësi të shumta edhe me kutitë drejtkëndore. Mund t'i kombinoni horizontalisht ose vertikalisht, individualisht ose në grupe. Korniza metalike e montimit siguron qëndrueshmëri të shkëlqyer edhe me përdorim të shpeshtë dhe është e përshtatshme për çdo kapak mbulues dekorativ.

The Modul enables a many possibilities even with round boxes. You can combine them horizontally or vertically, individually or in groups. The metal mounting frame ensures excellent stability even with rough use and is suitable for any decorative cover plates.

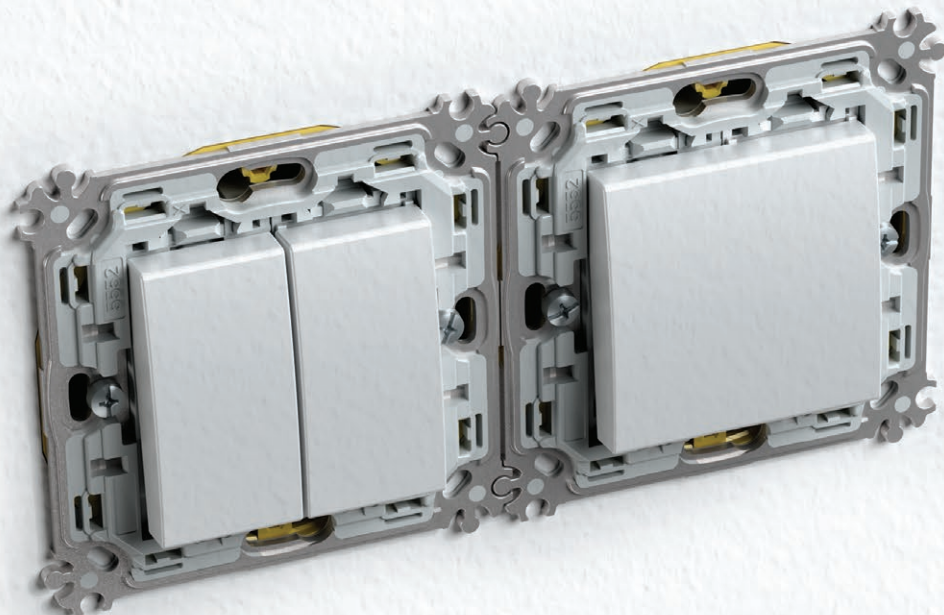



PW
e bardhë polare
polar white



MW
e bardhë mat
matte white



SB
e zezë soft touch
soft touch black



AT
antracit
anthracite



ES
e argjendtë elox
elox silver



IW
e bardhë fildishi
ivory white

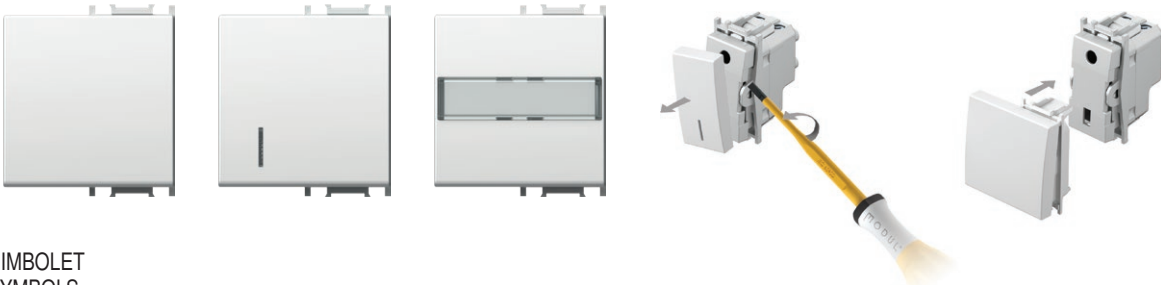

SIMBOLET SYMBOLS

01	02	03	04	05	06	07	08	09	10	11	12	13	14	20	21
													1 0 2	+	-
22	23	24	25	26	27	28	29	30	31	32	33	34	35	36	37
					alarm	alarm	OFF	ON	+				AC		
38	39	40	41	42	43	44	45	46	47	48					

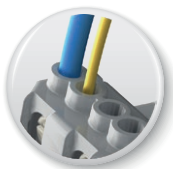
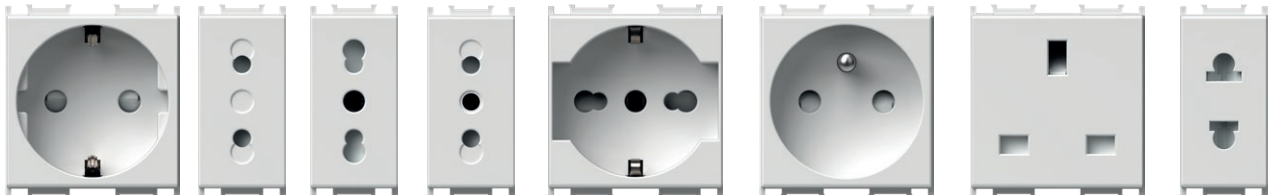

Lidhje e sigurt edhe kur përdoren madhësi të ndryshme telash.

Reliable connection even when different size of wires are used.



Të gjitha prizat janë të pajisura me mbyllëse sigurie që garantojnë mbrojtjen e kontakteve nën tension.

All the sockets are equipped with a safety shutters assuring the protection to live contacts.

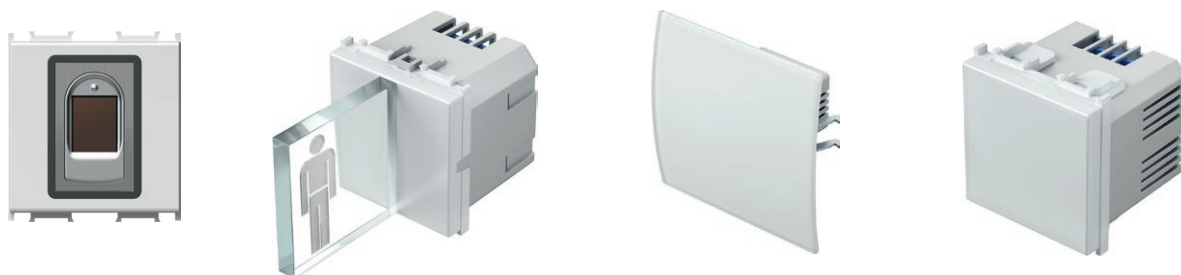
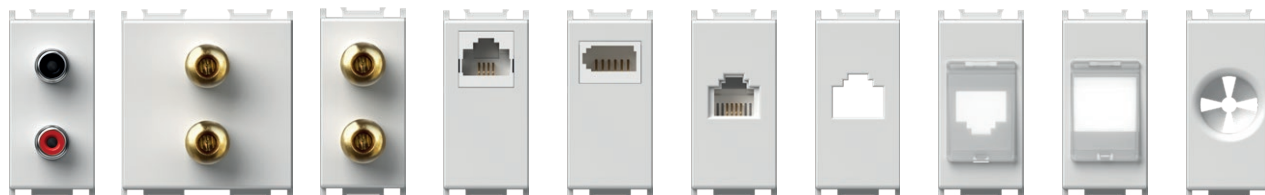

IEC
40.000
çelësat

Jetëgjatësi e çelësave dhe përputhje me standardet ndërkombëtare.

Long-life of switches and adequacy to the international standards.

16 AX
kontaktet

Çelësi është shumë i sigurt përmes kontakteve të përçinave prej argjendi.

The switch is highly reliable via its silver rivets contacts.





BIOPASS - çelës me gjurmë gishti

BIOPASS - fingerprint switch

Shkyçje pa çelës.

Keyless unlocking.

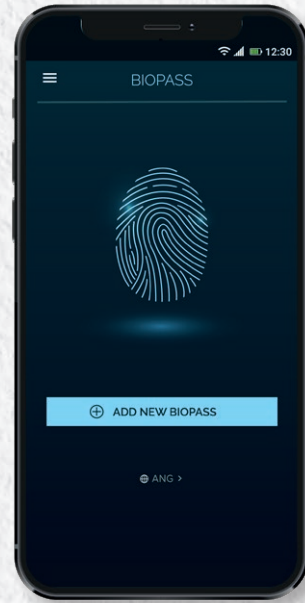

MULTIMEDIA

MULTIMEDIA

Qendër multimediale që do ju lejon të lidhni një numër të shumtë komponentësh në një vend.

Multimedia center that allows you to connect a multiple number of components in one place.



BËJENI UNIKE

MAKE IT UNIQUE

Zgjidhni një ngjyrë ndriçimi dhe shtoni grafikën e dëshiruar që i përshtatet atmosferës së dhomës suaj.

Choose a illumination colour and add desired graphic to suit the ambience of your room.



KRIJONI TUAJIN
CREATE YOUR OWN

Kur porositni sasi të mëdha, kapakët mbulues dhe elementet e funksionit mund të bëhen në ngjyrën e dëshiruar.

When ordering large quantities, cover plates and function elements can be made in the colour of your choice.





KOHËMATËS ME SHUMË FUNKSIONE

MULTIPURPOSE TIMER SWITCH

4 in 1

- kohëmatës
- releja
- butoni me shtypje
- çelësi

4 in 1

- timer
- relay
- push button
- switch

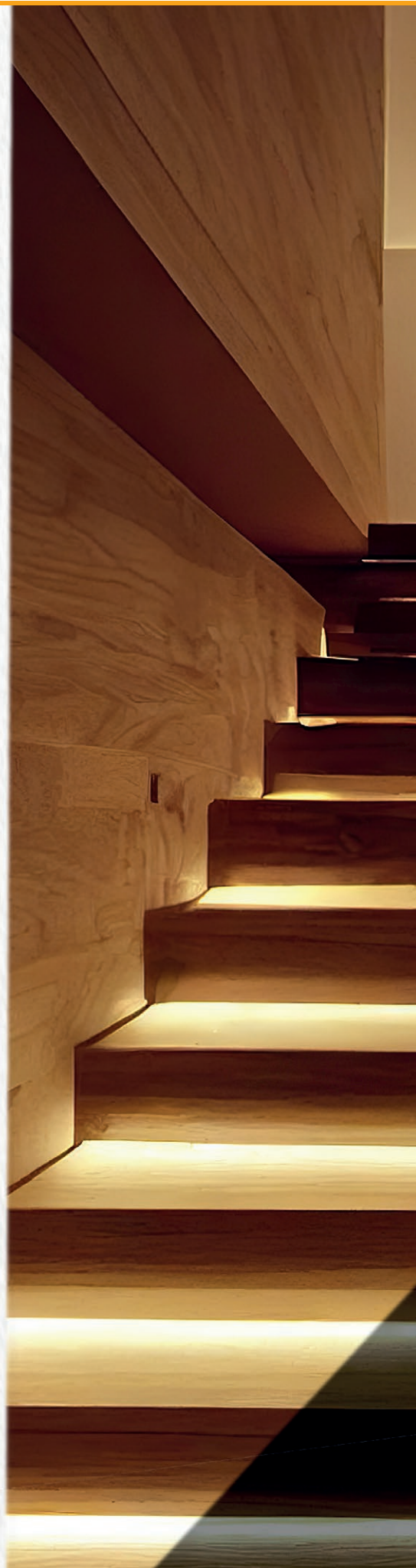

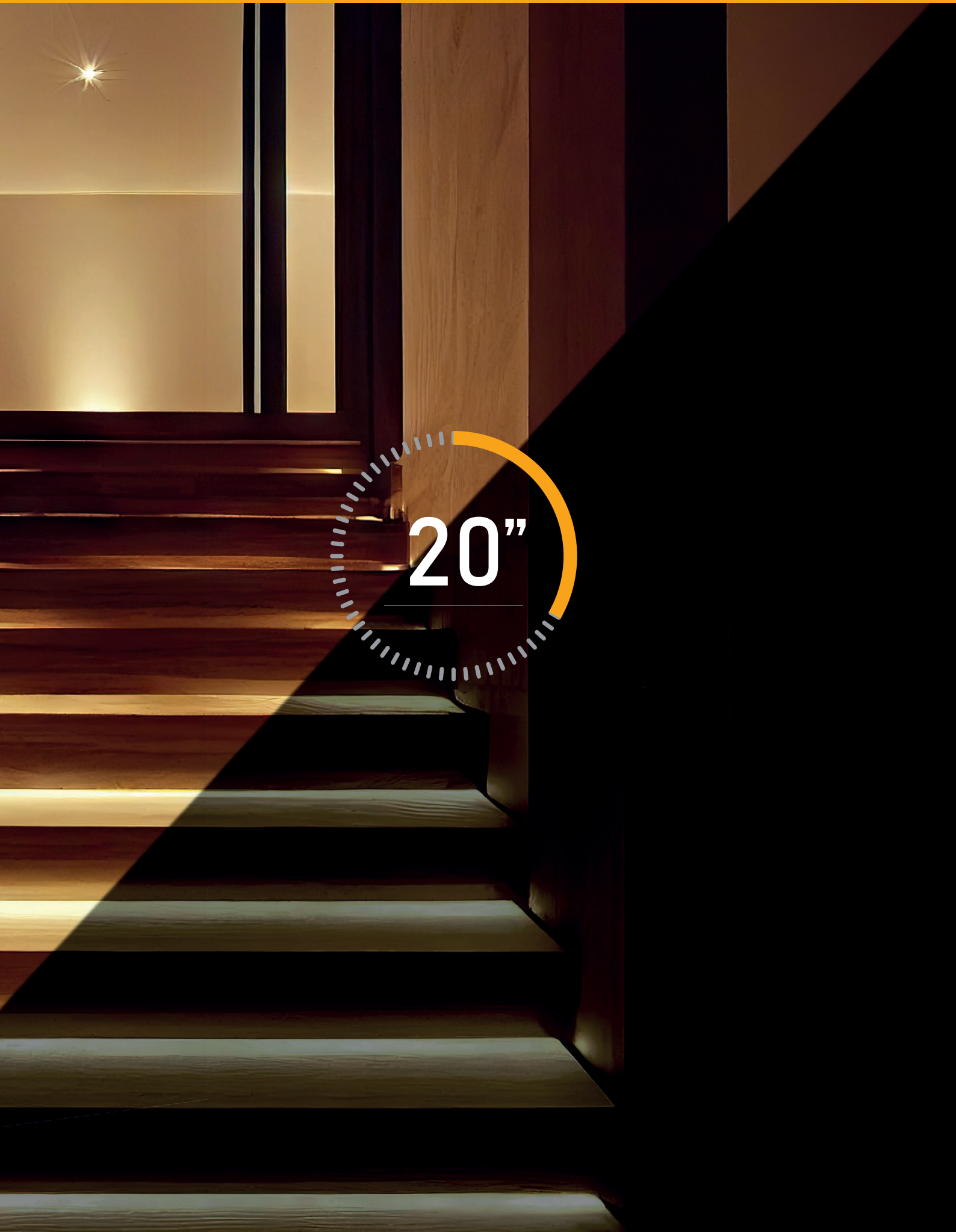

20"

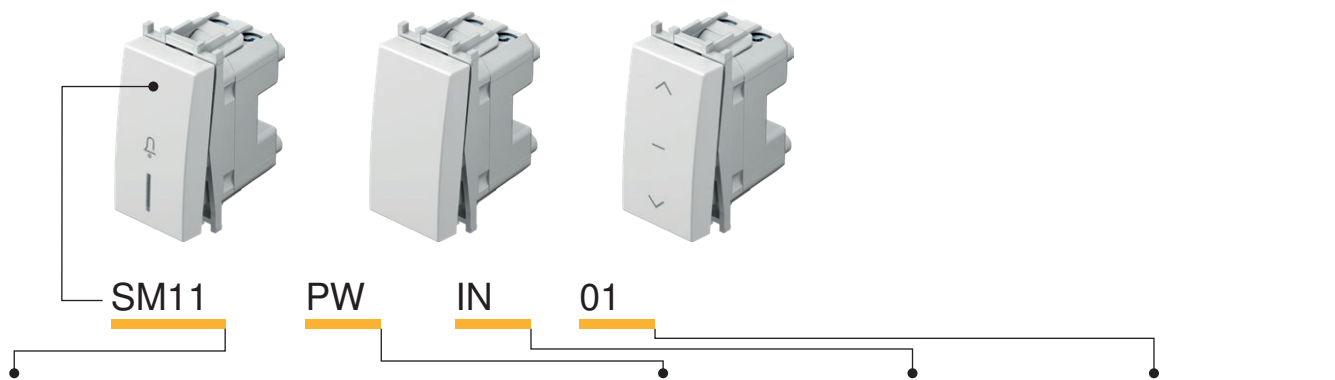

Iloji type	përshkrimi description	të dhënat teknike technical data	madhësia size	ngjyra colour	të dhënat opsionale 1 optional data 1	të dhënat opsionale 2 optional data 2
SM10	ÇELËS ME 1 DREJTIM SWITCH 1WAY	16AX 250V~	1M	<input type="checkbox"/> PW e bardhë polare polar white	<input type="checkbox"/> NT neutral neutral	01
SM11	BUTON MESHTYPJE ME 1 DREJTIM PUSH BUTTON 1WAY	16A 250V~	1M	<input type="checkbox"/> MW e bardhë mat matte white	<input type="checkbox"/> IN treguesi indicator	02
SM12	ÇELËS ME 1 DREJTIM SWITCH 1WAY	20A 250V~	1M	<input checked="" type="checkbox"/> SB e zezë soft touch soft touch black		03
⋮	⋮	⋮	⋮	<input type="checkbox"/> AT antracit anthracite		
⋮	⋮	⋮	⋮	<input type="checkbox"/> ES e argjendtë elox elox silver		
⋮	⋮	⋮	⋮	<input type="checkbox"/> IW e bardhë fildishi ivory white		

ÇELËS ME 1 DREJTIM 16 A X 250 V~ 1M



SM10

- çelës pa buton
- 16 A X 250 V~, Iloji SM10
- në përputhje me EN 60669-1
- kontaktet e vidave 1,5-2,5 mm²

SWITCH 1WAY 16AX 250V~ 1M

- switch without button
- 16AX 250V~, type SM10
- in accordance with EN 60669-1
- screw contacts 1.5-2.5mm²

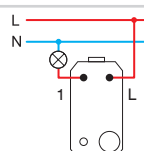

BUTON ME SHTYPJE ME 1 DREJTIM 16 A 250 V~ 1M



SM11

- buton me shtypje pa buton
- 16 A 250 V~, Iloji SM11
- në përputhje me EN 60669-1
- kontaktet e vidave 1,5-2,5 mm²

PUSH BUTTON 1WAY 16A 250V~ 1M

- push button without button
- 16A 250V~, type SM11
- in accordance with EN 60669-1
- screw contacts 1.5-2.5mm²

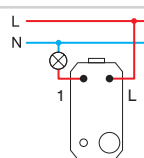

ÇELËS ME 1 DREJTIM 20 A 250 V~ 1M



SM12

- çelës pa buton
- 20 A 250 V~, Iloji SM12
- në përputhje me EN 60669-1
- kontaktet e vidave 1,5-2,5 mm²

SWITCH 1WAY 20A 250V~ 1M

- switch without button
- 20A 250V~, type SM12
- in accordance with EN 60669-1
- screw contacts 1.5-2.5mm²

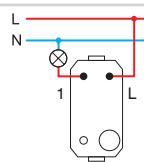

ÇELËS 2 POLAR 16 A X 250 V~ 1M



SM20

- çelës pa buton
- 16 A X 250 V~, Iloji SM20
- në përputhje me EN 60669-1
- kontaktet e vidave 1,5-2,5 mm²
- vetëm në kombinim me butonin TM15

SWITCH 2POLE 16AX 250V~ 1M

- switch without button
- 16AX 250V~, type SM20
- in accordance with EN 60669-1
- screw contacts 1.5-2.5mm²
- only in combination with button TM15

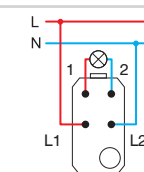

MBYLLËSE ÇELËSI 1-0-2 16 A X 250 V~ 1M



SM40



- çelës pa buton
 - 16 A X 250 V~, lloji SM40
 - në përputhje me EN 60669-1
 - kontaktet e vidave 1,5-2,5 mm²
- SWITCH SHUTTERS 1-0-2 16AX 250V~ 1M*
- switch without button
 - 16AX 250V~, type SM40
 - in accordance with EN 60669-1
 - screw contacts 1.5-2.5mm²

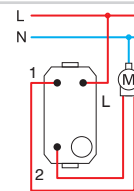

MBYLLËSE ÇELËSI 1-0-2 16 A X 250 V~ 1M



SM41

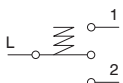

- buton me shtypje pa buton
 - 16 A 250 V~, lloji SM41
 - në përputhje me EN 60669-1
 - kontaktet e vidave 1,5-2,5 mm²
- PUSH BUTTON SHUTTERS 1-0-2 16A 250V~ 1M*
- push button without button
 - 16A 250V~, type SM41
 - in accordance with EN 60669-1
 - screw contacts 1.5-2.5mm²

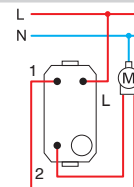

ÇELËS ME 2 DREJTIME 16 A X 250 V~ 1M



SM60

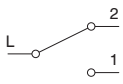

- çelës pa buton
 - 16 A X 250 V~, lloji SM60
 - në përputhje me EN 60669-1
 - kontaktet e vidave 1,5-2,5 mm²
- SWITCH 2WAY 16AX 250V~ 1M*
- switch without button
 - 16AX 250V~, type SM60
 - in accordance with EN 60669-1
 - screw contacts 1.5-2.5mm²

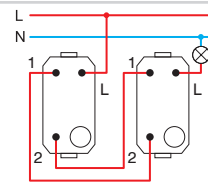

BUTON ME SHTYPJË ME 2 DREJTIME 16 A 250 V~ 1M



SM61

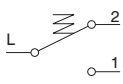

- buton me shtypje pa buton
 - 16 A 250 V~, lloji SM61
 - në përputhje me EN 60669-1
 - kontaktet e vidave 1,5-2,5 mm²
- PUSH BUTTON 2WAY 16A 250V~ 1M*
- push button without button
 - 16A 250V~, type SM61
 - in accordance with EN 60669-1
 - screw contacts 1.5-2.5mm²

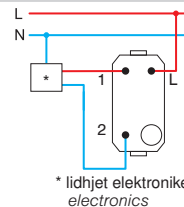

* lidhjet elektronike / electronics

ÇELËS NDËRMJETËS 16 A X 250 V~ 1M



SM70

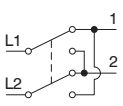

- çelës pa buton
 - 16 A X 250 V~, lloji SM70
 - në përputhje me EN 60669-1
 - kontaktet e vidave 1,5-2,5 mm²
- SWITCH INTERMEDIATE 16AX 250V~ 1M*
- switch without button
 - 16AX 250V~, type SM70
 - in accordance with EN 60669-1
 - screw contacts 1.5-2.5mm²

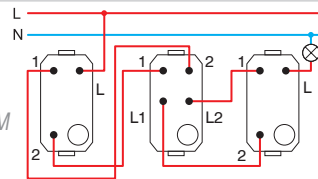

1M = 22,5 x 45
2M = 45 x 45

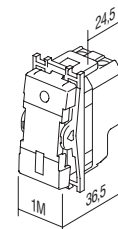
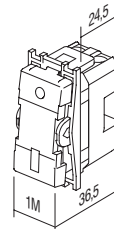



□ PW e bardhë polare
polar white
□ MW e bardhë mat
matte white



■ SB e zezë soft touch
soft touch black



■ AT antracit
anthracite



□ ES e argjendtë elox
elox silver



□ IW e bardhë fildishi
ivory white

ÇELËS ME 1 DREJTIM 16 A X 250 V~ 1M

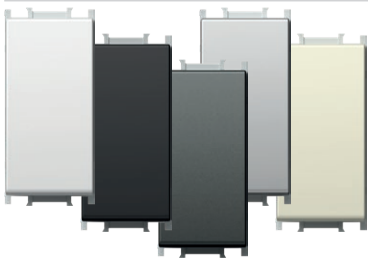

- SM10PW
- SM10MW
- SM10SB
- SM10AT
- SM10ES
- SM10IW

- 16 A X 250 V~, Iloji SM10
- në përputhje me EN 60669-1
- kontaktet e vidave 1,5-2,5 mm²
- buton i ndërrueshëm

SWITCH 1WAY 16AX 250V~ 1M
- 16AX 250V~, type SM10
- in accordance with EN 60669-1
- screw contacts 1.5-2.5 mm²
- replaceable button



ÇELËS ME 1 DREJTIM 16 A X 250 V~ 1M __ IN



- SM10PWIN
- SM10MWIN
- SM10SBIN
- SM10ATIN
- SM10ESIN
- SM10IWIN

- IN tregues
- 16 A X 250 V~, Iloji SM10
- në përputhje me EN 60669-1
- kontaktet e vidave 1,5-2,5 mm²
- llamba nuk është e përfshirë
- buton i ndërrueshëm

SWITCH 1WAY 16AX 250V~ 1M __ IN
- IN indicator
- 16AX 250V~, type SM10
- in accordance with EN 60669-1
- screw contacts 1.5-2.5 mm²
- lamp is not included
- replaceable button



BUTON ME SHTYPJE ME 1 DREJTIM 16 A 250 V~ 1M

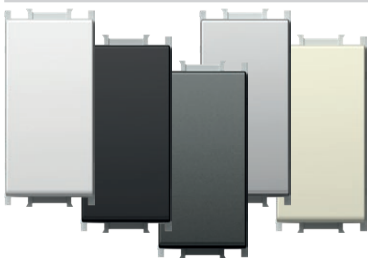

- SM11PW
- SM11MW
- SM11SB
- SM11AT
- SM11ES
- SM11IW

- 16 A 250 V~, Iloji SM11
- në përputhje me EN 60669-1
- kontaktet e vidave 1,5-2,5 mm²
- buton i ndërrueshëm

PUSH BUTTON 1WAY 16A 250V~ 1M
- 16A 250V~, type SM11
- in accordance with EN 60669-1
- screw contacts 1.5-2.5 mm²
- replaceable button



BUTON ME SHTYPJE ME 1 DREJTIM 16 A 250 V~ 1M __ IN 01



- SM11PWIN01
- SM11MWIN01
- SM11SBIN01
- SM11ATIN01
- SM11ESIN01
- SM11IWIN01

- IN 01 zile treguese
- 16 A 250 V~, Iloji SM11
- në përputhje me EN 60669-1
- kontaktet e vidave 1,5-2,5 mm²
- llamba nuk është e përfshirë
- buton i ndërrueshëm

PUSH BUTTON 1WAY 16A 250V~ 1M __ IN 01
- IN 01 indicator bell
- 16A 250V~, type SM11
- in accordance with EN 60669-1
- screw contacts 1.5-2.5 mm²
- lamp is not included
- replaceable button



S W I T C H E S S M

BUTON ME SHTYPJE ME 1 DREJTIM 16 A 250 V~ 1M __ IN 02



- SM11PWIN02
- SM11MWIN02
- SM11SBIN02
- SM11ATIN02
- SM11ESIN02
- SM11IWIN02

- IN 02 dritë treguese
- 16 A 250 V~, lloji SM11
- në përputhje me EN 60669-1
- kontaktet e vidave 1,5-2,5 mm²
- llamba nuk është e përfshirë
- buton i ndërrueshëm

PUSH BUTTON 1WAY 16A 250V~ 1M __ IN 02

- IN 02 indicator light
- 16A 250V~, type SM11
- in accordance with EN 60669-1
- screw contacts 1.5-2.5 mm²
- lamp is not included
- replaceable button



ÇELËS 2 POLAR 16 A X 250 V~ 1M __ NT 03

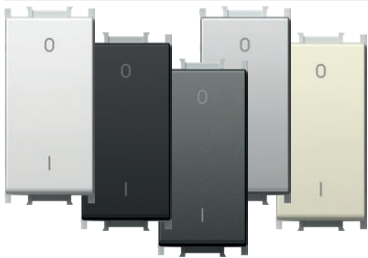

- SM20PWNT03
- SM20MWNT03
- SM20SBNT03
- SM20ATNT03
- SM20ESNT03
- SM20IWNNT03

- NT 03 neutral 0-1
- 16 A X 250 V~, lloji SM20
- në përputhje me EN 60669-1
- kontaktet e vidave 1,5-2,5 mm²
- buton i ndërrueshëm

SWITCH 2POLE 16AX 250V~ 1M __ NT 03

- NT 03 neutral 0-1
- 16AX 250V~, type SM20
- in accordance with EN 60669-1
- screw contacts 1.5-2.5 mm²
- replaceable button



ÇELËS 2 POLAR 16 A X 250 V~ 1M __ IN

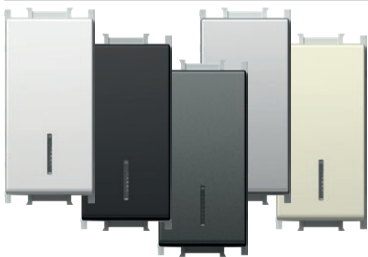

- SM20PWIN
- SM20MWIN
- SM20SBIN
- SM20ATIN
- SM20ESIN
- SM20IWIN

- IN tregues
- 16 A X 250 V~, lloji SM20
- në përputhje me EN 60669-1
- kontaktet e vidave 1,5-2,5 mm²
- llamba nuk është e përfshirë
- buton i ndërrueshëm

SWITCH 2POLE 16AX 250V~ 1M __ IN

- IN indicator
- 16AX 250V~, type SM20
- in accordance with EN 60669-1
- screw contacts 1.5-2.5 mm²
- lamp is not included
- replaceable button



MBYLLËSE ÇELËSI 1-0-2 16 A X 250 V~ 1M __ NT 10

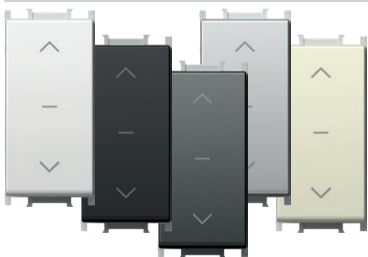

- SM40PWNT10
- SM40MWNT10
- SM40SBNT10
- SM40ATNT10
- SM40ESNT10
- SM40IWNNT10

- NT 10 neutral 1-0-2
- 16 A X 250 V~, lloji SM40
- në përputhje me EN 60669-1
- kontaktet e vidave 1,5-2,5 mm²
- buton i ndërrueshëm

SWITCH SHUTTERS 1-0-2 16AX 250V~ 1M __ NT 10

- NT 10 neutral 1-0-2
- 16AX 250V~, type SM40
- in accordance with EN 60669-1
- screw contacts 1.5-2.5mm²
- replaceable button



MBYLLËSE BUTONI ME SHTYPJE 1-0-2 16 A 250 V~ 1M __ NT 10

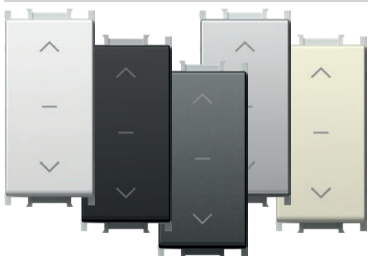

- SM41PWNT10
- SM41MWNT10
- SM41SBNT10
- SM41ATNT10
- SM41ESNT10
- SM41IWNNT10

- NT 10 neutral 1-0-2
- 16 A 250 V~, lloji SM41
- në përputhje me EN 60669-1
- kontaktet e vidave 1,5-2,5 mm²
- buton i ndërrueshëm

PUSH BUTTON SHUTTERS 1-0-2 16A 250V~ 1M __ NT 10

- NT 10 neutral 1-0-2
- 16A 250V~, type SM41
- in accordance with EN 60669-1
- screw contacts 1.5-2.5mm²
- replaceable button



ÇELËS ME 2 DREJTIME 16 A X 250 V~ 1M



- SM60PW
- SM60MW
- SM60SB
- SM60AT
- SM60ES
- SM60IW

- 16 A X 250 V~, lloji SM60
- në përputhje me EN 60669-1
- kontaktet e vidave 1,5-2,5 mm²
- buton i ndërrueshëm

SWITCH 2WAY 16AX 250V~ 1M

- 16AX 250V~, type SM60
- in accordance with EN 60669-1
- screw contacts 1.5-2.5 mm²
- replaceable button



BUTON ME SHYTPJE ME 2 DREJTIME 16 A 250 V~ 1M



- SM61PW
- SM61MW
- SM61SB
- SM61AT
- SM61ES
- SM61IW

- 16 A 250 V~, Iloji SM61
 - në përputhje me EN 60669-1
 - kontaktet e vidave 1,5-2,5 mm²
 - buton i ndërrueshëm

PUSH BUTTON 2WAY 16A 250V~ 1M

- 16A 250V~, type SM61
 - in accordance with EN 60669-1
 - screw contacts 1.5-2.5 mm²
 - replaceable button



BUTON ME SHYTPJE ME 2 DREJTIME ME KORDON 16 A 250 V~ 1M __ CD



- SM62PWCD
- SM62MWCD
- SM62SB CD
- SM62AT CD
- SM62ESCD
- SM62IWCD

- CD treguesi+kordoni
 - gjatësia e kordonit 1.5 m
 - 16 A 250 V~, Iloji SM62
 - në përputhje me EN 60669-1
 - kontaktet e vidave 1,5-2,5 mm²

PUSH BUTTON 2WAY WITH CORD 16A 250V~ 1M __ CD

- CD indicator+cord
 - cord lenght 1.5m
 - 16A 250V~, type SM62
 - in accordance with EN 60669-1
 - screw contacts 1.5-2.5 mm²



ÇELËS NDËRMJETËS 16 A X 250 V~ 1M

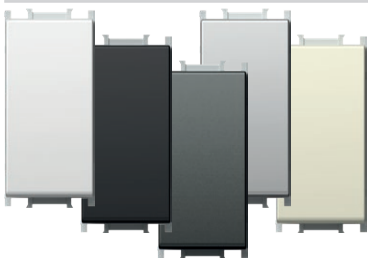

- SM70PW
- SM70MW
- SM70SB
- SM70AT
- SM70ES
- SM70IW

- 16 A X 250 V~, Iloji SM70
 - në përputhje me EN 60669-1
 - kontaktet e vidave 1,5-2,5 mm²
 - buton i ndërrueshëm

SWITCH INTERMEDIATE 16AX 250V~ 1M

- 16AX 250V~, type SM70
 - in accordance with EN 60669-1
 - screw contacts 1.5-2.5 mm²
 - replaceable button



1M = 22,5 x 45
 2M = 45 x 45

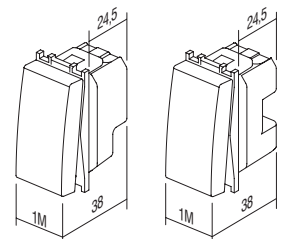

B U T T O N S T M

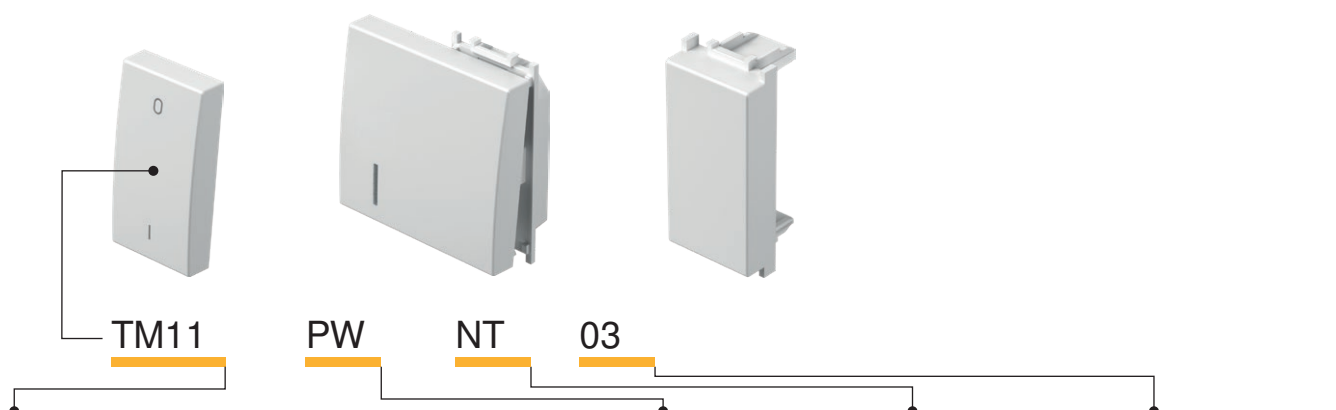

Iloji type	përshkrimi description	madhësia size	ngjyra colour	të dhënat opsionale 1 optional data 1	të dhënat opsionale 2 optional data 2
TM11	BUTON BUTTON	1M	<input type="checkbox"/> PW e bardhë polare polar white	NT neutral neutral	01
TM12	BUTON BUTTON	2M	<input type="checkbox"/> MW e bardhë mat matte white	IN treguesi indicator	02
TM21	FALSO BLANK	1M	<input checked="" type="checkbox"/> SB e zezë soft touch soft touch black		03
:	:	:	<input type="checkbox"/> AT antracit anthracite		
:	:	:	<input type="checkbox"/> ES e argjendtë elox elox silver		
:	:	:	<input type="checkbox"/> IW e bardhë fildishi ivory white		

BUTON 1M

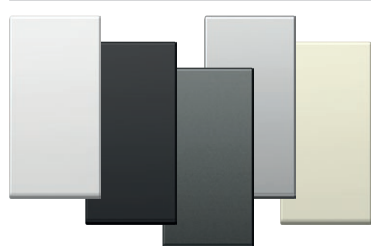

- TM11PW
- TM11MW
- TM11SB
- TM11AT
- TM11ES
- TM11IW

- buton i ndërrueshëm 1M
- në përputhje me EN 60669-1
BUTTON 1M
- replaceable button 1M
- in accordance with EN 60669-1



TREGUES BUTONI 1M



- TM11PWIN
- TM11MWIN
- TM11SBIN
- TM11ATIN
- TM11ESIN
- TM11IWIN

- buton i ndërrueshëm 1M
- në përputhje me EN 60669-1
BUTTON 1M INDICATOR
- replaceable button 1M
- in accordance with EN 60669-1



BUTON 2M

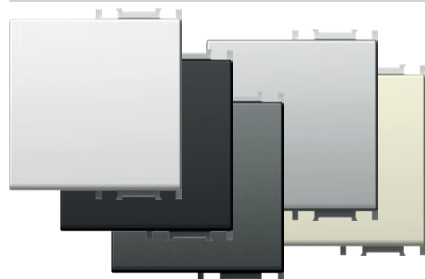

- TM12PW
- TM12MW
- TM12SB
- TM12AT
- TM12ES
- TM12IW

- buton i ndërrueshëm 2M me mbajtëse butoni
- për të përditësuar çelësin ose butonin me shtypje nga madhësia 1M në madhësinë 2M
- në përputhje me EN 60669-1
BUTTON 2M
- replaceable button 2M with button carrier
- to upgrade switch or push button from size 1M to size 2M
- in accordance with EN 60669-1



TREGUES BUTONI 2M

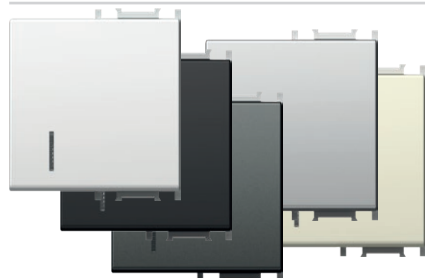

- TM12PWIN
- TM12MWIN
- TM12SBIN
- TM12ATIN
- TM12ESIN
- TM12IWIN

- buton i ndërrueshëm 2M me mbajtëse butoni
- për të përditësuar çelësin ose butonin me shtypje nga madhësia 1M në madhësinë 2M
- në përputhje me EN 60669-1
BUTTON 2M INDICATOR
- replaceable button 2M with button carrier
- to upgrade switch or push button from size 1M to size 2M
- in accordance with EN 60669-1



BUTON 2M ME KAPAK ME MBISHKRIM

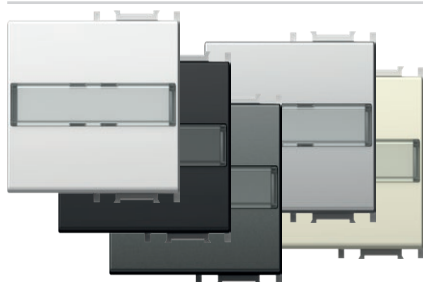

- TM13PWIL
- TM13MWIL
- TM13SBIL
- TM13ATIL
- TM13ESIL
- TM13IWIL

- buton i ndërrueshëm 2M me mbajtëse butoni
 - për të përditësuar çelësin ose butonin me shtypje nga madhësia 1M në madhësinë 2M
 - në përputhje me EN 60669-1

BUTTON 2M WITH INSCRIPTION PLATE
 - replaceable button 2M with button carrier
 - to upgrade switch or push button from size 1M to size 2M
 - in accordance with EN 60669-1



BUTON 1M 2 POLAR

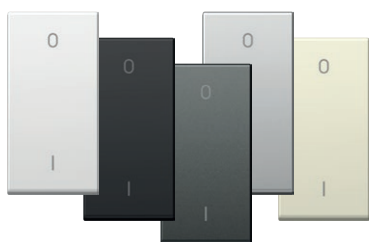

- TM15PW
- TM15MW
- TM15SB
- TM15AT
- TM15ES
- TM15IW

- buton i ndërrueshëm 1M
 - vetëm në kombinim me mekanizmin SM20
 - në përputhje me EN 60669-1

BUTTON 1M 2POLE
 - replaceable button 1M
 - only in combination with mechanism SM20
 - in accordance with EN 60669-1



FALSO 1M

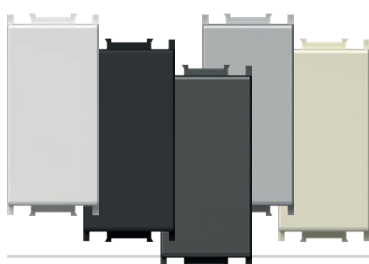

- TM21PW
- TM21MW
- TM21SB
- TM21AT
- TM21ES
- TM21IW

- modul falso për të mbushur hapësirat boshe
 - në përputhje me EN 60669-1

BLANK 1M
 - blank modul to fill up empty spaces
 - in accordance with EN 60669-1



FALSO 2M

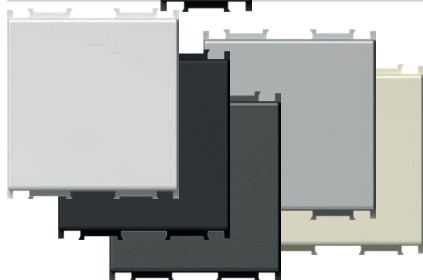

- TM22PW
- TM22MW
- TM22SB
- TM22AT
- TM22ES
- TM22IW

- modul falso për të mbushur hapësirat boshe
 - në përputhje me EN 60669-1

BLANK 2M
 - blank modul to fill up empty spaces
 - in accordance with EN 60669-1

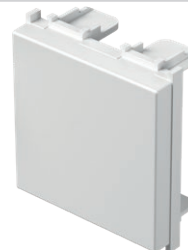

DALJE PËR KABLO 1M

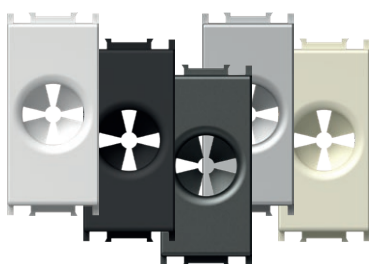

- TM31PW
- TM31MW
- TM31SB
- TM31AT
- TM31ES
- TM31IW

- dalje për kablo
 - në përputhje me EN-60669-1

CABLE OUTLET 1M
 - outlet for cable
 - in accordance with EN-60669-1



1M = 22,5 x 45
 2M = 45 x 45



TM11
 TM15

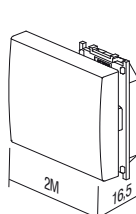

TM12
 TM13

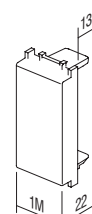

TM21

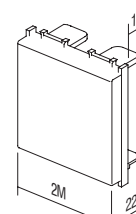

TM22

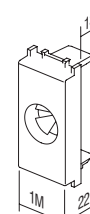

TM31

B U T T O N S T M

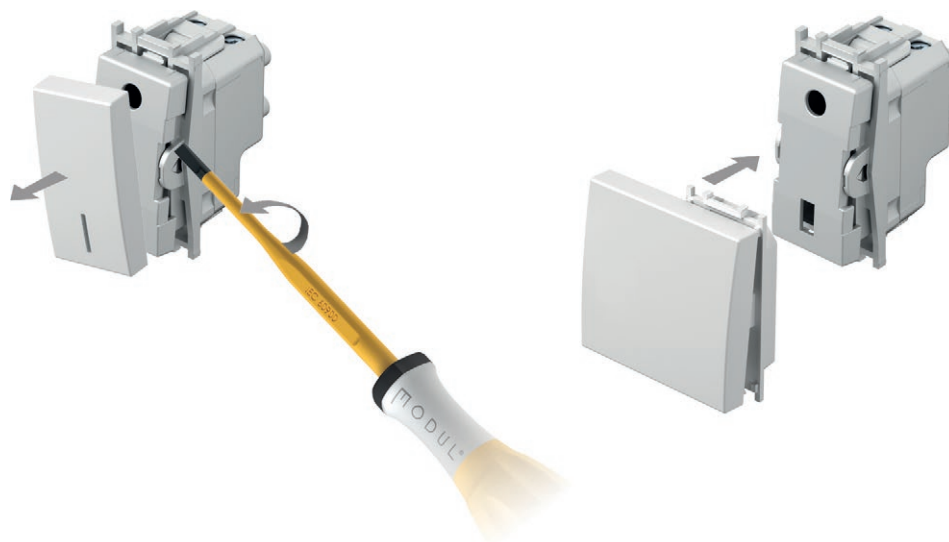

PRINTIM ME LAZER MBI BUTONA

- printim me lazer i çdo lloj grafike në vendet e shënuara
- simbole standarde nga stoku, të tjerat sipas kërkesës

LASER PRINT ON BUTTONS

- laser print of any graphics on marked locations
- standard symbols from stock, other on request

1M

A
B
C

2M

A	D	G
B	E	H
C	F	I

SIMBOLET

SYMBOLS

01	02	03	04	05	06	07	08	09	10	11	12	13	14	20	21
													1	+	-
22	23	24	25	26	27	28	29	30	31	32	33	34	35	36	37
					alarm	alarm	OFF	ON	+				AC		
38	39	40	41	42	43	44	45	46	47	48					

SIMBOLET STANDARDE

STANDARD SYMBOLS

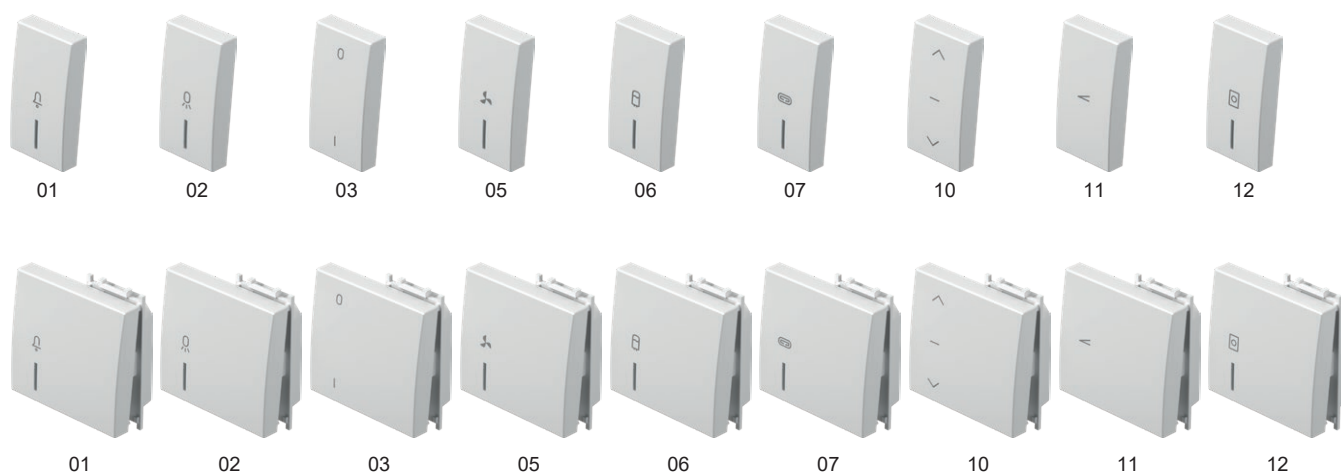

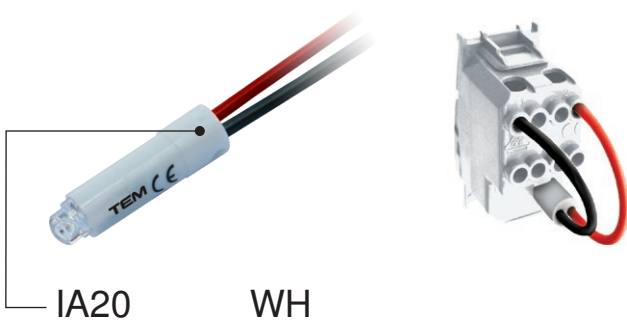

Iloji type	përshkrimi description	të dhënat teknike technical data	ngjyra colour
IA10	LLAMBË NEONI NEON LAMP	230V~ 0,34W	<input type="checkbox"/> WH e bardhë white
IA20	SINJALIZIMI LED LED SIGNALLING UNIT	230V~ AC/DC 0,40W	<input checked="" type="checkbox"/> BL blu blue
IA21	SINJALIZIMI LED LED SIGNALLING UNIT	24V AC/DC 0,20W	<input checked="" type="checkbox"/> RD e kuqe red
·	·	·	<input checked="" type="checkbox"/> GR e gjelbër green
·	·	·	<input checked="" type="checkbox"/> OR portokalli orange

LLAMBË NEONI 230 V~ 0,34 W

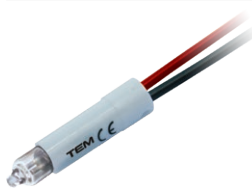

IA10OR

- për indikim, sinjalizim ose sinjalizim të përhershëm
- në kombinim me një buton që ka një tregues

NEON LAMP 230V~ 0,34W

- for indication, signalling or permanent signalling
- in combination with a button featuring an indicator

SINJALIZIMI LED 230 V AC/DC 0,40 W



- IA20WH
- IA20GR
- IA20RD
- IA20BL

- për indikim, sinjalizim ose sinjalizim të përhershëm
- në kombinim me një buton që ka një tregues

LED SIGNALLING UNIT 230V AC/DC 0,40W

- for indication, signalling or permanent signalling
- in combination with a button featuring an indicator

SINJALIZIMI LED 24V AC/DC 0,20W



- IA21WH
- IA21RD

- për indikim, sinjalizim ose sinjalizim të përhershëm
- në kombinim me një buton që ka një tregues

LED SIGNALLING UNIT LAMP 24V AC/DC 0,20W

- for indication, signalling or permanent signalling
- in combination with a button featuring an indicator

SINJALIZIMI LED 12V AC/DC 0,10W



- IA22WH
- IA22RD

- për indikim, sinjalizim ose sinjalizim të përhershëm
- në kombinim me një buton që ka një tregues

LED SIGNALLING UNIT 12V AC/DC 0,10W

- for indication, signalling or permanent signalling
- in combination with a button featuring an indicator

QARK RC 250 V~



IA50

- qark RC për të eliminuar ndërhyrjet në funksionim të llambave LED
- lidhje paralele me më shumë qarqe RC dhe llamba janë të mundshme
- 0,1 µF, 100 Ω, 250V~

RC CIRCUIT 250V~

- RC circuit to eliminate disturbances in the operation of LED lamps
- parallel connections of more RC circuits with lamps are possible
- 0,1 µF, 100 Ω, 250V~

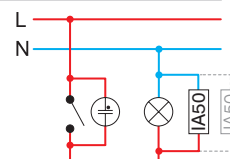

S I G N A L I Z A T I O N I A

Treguesi /
Indication

* Sinjalizimi /
Signalization

Sinjalizimi i përhershëm /
Permanent signalling

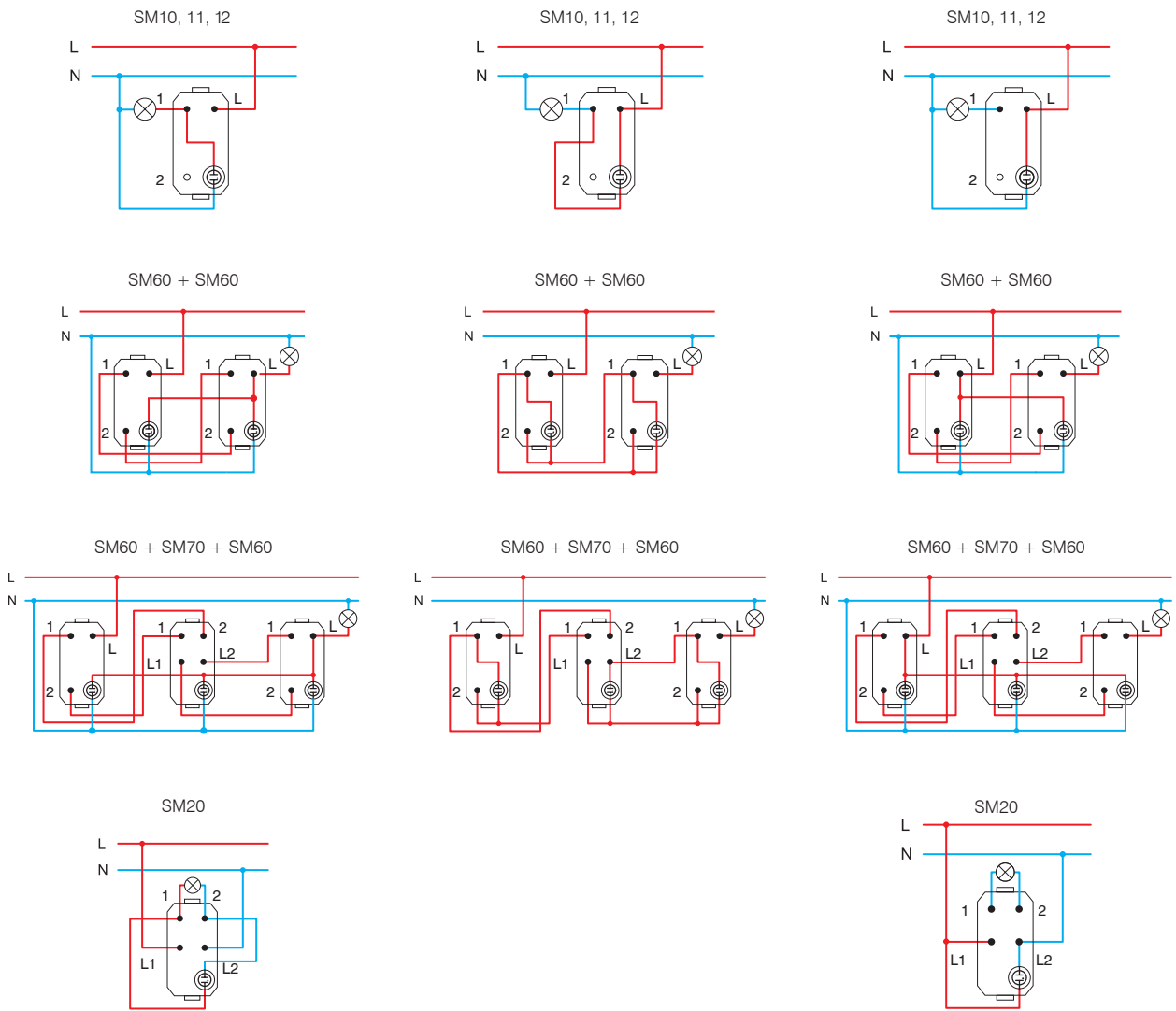

* lidhjet nuk janë të përshtatshme për llambat që kursejnë energji (CFL, LED) /
the connections are not suitable for energy-saving bulbs (CFL, LED)

1M = 22,5 x 45
2M = 45 x 45

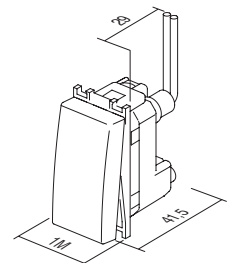

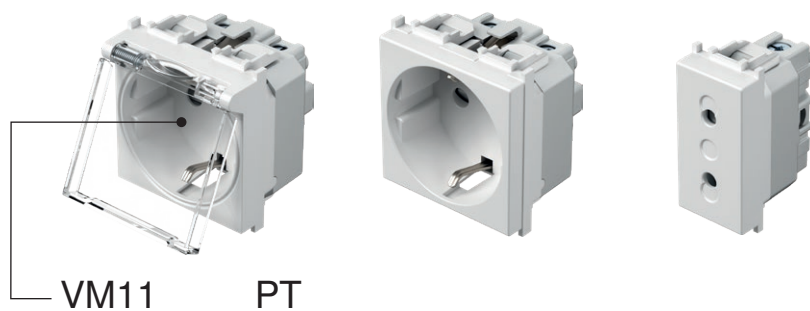

lloji type	përshkrimi description	të dhënat teknike technical data	madhësia size	ngjyra colour																					
VM10	PRIZË SCHUKO+KS SOCKET SCHUKO+KS	2P+E 16A 250V~	2M	<table border="0"> <tr> <td><input type="checkbox"/> PW e bardhë polare polar white</td> <td><input checked="" type="checkbox"/> PT e bardhë+transparente white+transparent</td> <td><input type="checkbox"/> PP e bardhë+e bardhë white+white</td> </tr> </table>	<input type="checkbox"/> PW e bardhë polare polar white	<input checked="" type="checkbox"/> PT e bardhë+transparente white+transparent	<input type="checkbox"/> PP e bardhë+e bardhë white+white																		
<input type="checkbox"/> PW e bardhë polare polar white	<input checked="" type="checkbox"/> PT e bardhë+transparente white+transparent	<input type="checkbox"/> PP e bardhë+e bardhë white+white																							
VM11	PRIZË SCHUKO+KS+KAPAK SOCKET SCHUKO+KS+COVER	2P+E 16A 250V~	2M	<table border="0"> <tr> <td><input type="checkbox"/> MW e bardhë mat matte white</td> <td><input checked="" type="checkbox"/> MT e bardhë+transparente white+transparent</td> <td><input type="checkbox"/> MM e bardhë+e bardhë white+white</td> </tr> </table>	<input type="checkbox"/> MW e bardhë mat matte white	<input checked="" type="checkbox"/> MT e bardhë+transparente white+transparent	<input type="checkbox"/> MM e bardhë+e bardhë white+white																		
<input type="checkbox"/> MW e bardhë mat matte white	<input checked="" type="checkbox"/> MT e bardhë+transparente white+transparent	<input type="checkbox"/> MM e bardhë+e bardhë white+white																							
VM20	PRIZË EURO+KS SOCKET EURO+KS	2P 10A 250V~	1M	<table border="0"> <tr> <td><input checked="" type="checkbox"/> SB e zehtë soft touch soft touch black</td> <td><input checked="" type="checkbox"/> BT e zehtë+transparente soft touch black+transparent</td> <td><input checked="" type="checkbox"/> BB e zehtë+e zehtë soft touch black+black</td> </tr> <tr> <td><input checked="" type="checkbox"/> AT antracit anthracite</td> <td><input checked="" type="checkbox"/> AT antracit+transparente anthracite+transparent</td> <td><input checked="" type="checkbox"/> AA antracit+antracit anthracite+anthracite</td> </tr> <tr> <td><input checked="" type="checkbox"/> ES e argjendë elox elox silver</td> <td><input checked="" type="checkbox"/> ST e argjendë+transparente silver+transparent</td> <td><input checked="" type="checkbox"/> SS e argjendë+e argjendë silver+silver</td> </tr> <tr> <td><input checked="" type="checkbox"/> IW e bardhë fildishi ivory white</td> <td><input checked="" type="checkbox"/> IT e fildishtë+transparente ivory+transparent</td> <td><input checked="" type="checkbox"/> II e fildishtë+e fildishtë ivory+ivory</td> </tr> <tr> <td><input checked="" type="checkbox"/> RD e kuqe red</td> <td><input checked="" type="checkbox"/> RT e kuqe+transparente red+transparent</td> <td><input checked="" type="checkbox"/> RR e kuqe+e kuqe red+red</td> </tr> <tr> <td><input checked="" type="checkbox"/> GR e gjelbër green</td> <td><input checked="" type="checkbox"/> GT e gjelbër+transparente green+transparent</td> <td><input checked="" type="checkbox"/> GG e gjelbër+e gjelbër green+green</td> </tr> <tr> <td><input checked="" type="checkbox"/> OR portokalli orange</td> <td><input checked="" type="checkbox"/> OT portokalli+transparente orange+transparent</td> <td><input checked="" type="checkbox"/> OO portokalli+portokalli orange+orange</td> </tr> </table>	<input checked="" type="checkbox"/> SB e zehtë soft touch soft touch black	<input checked="" type="checkbox"/> BT e zehtë+transparente soft touch black+transparent	<input checked="" type="checkbox"/> BB e zehtë+e zehtë soft touch black+black	<input checked="" type="checkbox"/> AT antracit anthracite	<input checked="" type="checkbox"/> AT antracit+transparente anthracite+transparent	<input checked="" type="checkbox"/> AA antracit+antracit anthracite+anthracite	<input checked="" type="checkbox"/> ES e argjendë elox elox silver	<input checked="" type="checkbox"/> ST e argjendë+transparente silver+transparent	<input checked="" type="checkbox"/> SS e argjendë+e argjendë silver+silver	<input checked="" type="checkbox"/> IW e bardhë fildishi ivory white	<input checked="" type="checkbox"/> IT e fildishtë+transparente ivory+transparent	<input checked="" type="checkbox"/> II e fildishtë+e fildishtë ivory+ivory	<input checked="" type="checkbox"/> RD e kuqe red	<input checked="" type="checkbox"/> RT e kuqe+transparente red+transparent	<input checked="" type="checkbox"/> RR e kuqe+e kuqe red+red	<input checked="" type="checkbox"/> GR e gjelbër green	<input checked="" type="checkbox"/> GT e gjelbër+transparente green+transparent	<input checked="" type="checkbox"/> GG e gjelbër+e gjelbër green+green	<input checked="" type="checkbox"/> OR portokalli orange	<input checked="" type="checkbox"/> OT portokalli+transparente orange+transparent	<input checked="" type="checkbox"/> OO portokalli+portokalli orange+orange
<input checked="" type="checkbox"/> SB e zehtë soft touch soft touch black	<input checked="" type="checkbox"/> BT e zehtë+transparente soft touch black+transparent	<input checked="" type="checkbox"/> BB e zehtë+e zehtë soft touch black+black																							
<input checked="" type="checkbox"/> AT antracit anthracite	<input checked="" type="checkbox"/> AT antracit+transparente anthracite+transparent	<input checked="" type="checkbox"/> AA antracit+antracit anthracite+anthracite																							
<input checked="" type="checkbox"/> ES e argjendë elox elox silver	<input checked="" type="checkbox"/> ST e argjendë+transparente silver+transparent	<input checked="" type="checkbox"/> SS e argjendë+e argjendë silver+silver																							
<input checked="" type="checkbox"/> IW e bardhë fildishi ivory white	<input checked="" type="checkbox"/> IT e fildishtë+transparente ivory+transparent	<input checked="" type="checkbox"/> II e fildishtë+e fildishtë ivory+ivory																							
<input checked="" type="checkbox"/> RD e kuqe red	<input checked="" type="checkbox"/> RT e kuqe+transparente red+transparent	<input checked="" type="checkbox"/> RR e kuqe+e kuqe red+red																							
<input checked="" type="checkbox"/> GR e gjelbër green	<input checked="" type="checkbox"/> GT e gjelbër+transparente green+transparent	<input checked="" type="checkbox"/> GG e gjelbër+e gjelbër green+green																							
<input checked="" type="checkbox"/> OR portokalli orange	<input checked="" type="checkbox"/> OT portokalli+transparente orange+transparent	<input checked="" type="checkbox"/> OO portokalli+portokalli orange+orange																							



PRIZË SCHUKO+KS 2P+E 16 A 250 V~ 2M

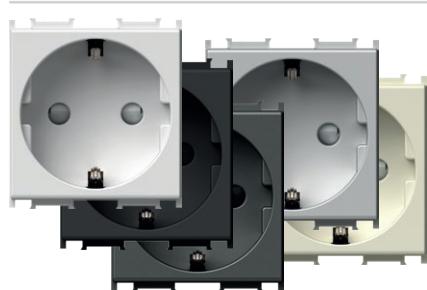

- VM10PW
- VM10MW
- VM10SB
- VM10AT
- VM10ES
- VM10IW

- 2P+E schuko
- 16 A 250 V~, lloji VM10
- në përputhje me IEC 60884-1, CEE7
- kontaktet e vidave 1,5-2,5 mm²
- kontaktet me rrymën të mbuluara

SOCKET SCHUKO+KS 2P+E 16A 250V~ 2M

- 2P+E schuko
- 16A 250V~, type VM10
- in accordance with IEC 60884-1, CEE7
- screw contacts 1.5-2.5 mm²
- shuttered live contacts



PRIZË SCHUKO+KS 2P+E 16 A 250 V~ 2M

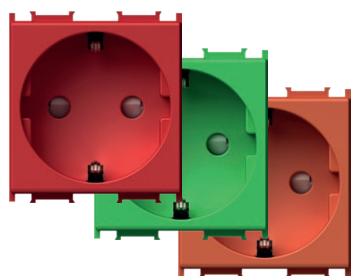

- VM10RD
- VM10GR
- VM10OR

- 2P+E schuko
- 16 A 250 V~, lloji VM10
- në përputhje me IEC 60884-1, CEE7
- kontaktet e vidave 1,5-2,5 mm²
- kontaktet me rrymën të mbuluara

SOCKET SCHUKO+KS 2P+E 16A 250V~ 2M

- 2P+E schuko
- 16A 250V~, type VM10
- in accordance with IEC 60884-1, CEE7
- screw contacts 1.5-2.5 mm²
- shuttered live contacts



PRIZË SCHUKO+KS+KAPAK 2P+E 16 A 250 V~ 2M

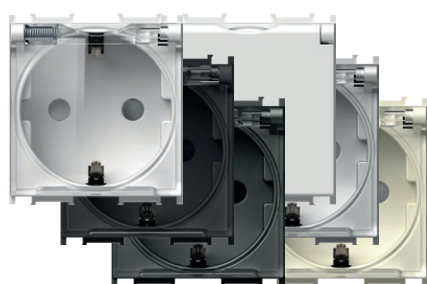

- VM11PT
- VM11MT
- VM11BT
- VM11AT
- VM11ST
- VM11IT
- VM11PP

- 2P+E schuko+kapak
- 16 A 250 V~, lloji VM11
- në përputhje me IEC 60884-1, CEE7
- kontaktet e vidave 1,5-2,5 mm²
- kontaktet me rrymën të mbuluara

SOCKET SCHUKO+KS+COVER

- 2P+E 16A 250V~ 2M
- 2P+E schuko+cover
- 16A 250V~, type VM11
- in accordance with IEC 60884-1, CEE7
- screw contacts 1.5-2.5 mm²
- shuttered live contacts



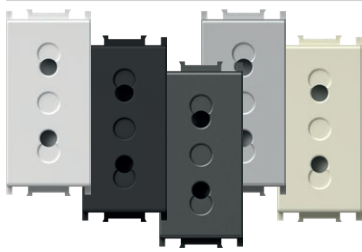

- VM20PW
- VM20MW
- VM20SB
- VM20AT
- VM20ES
- VM20IW

PRIZË EURO+KS 2P 10A 250 V~ 1M

- 2P Euro
- 10A 250 V~, lloji VM20
- në përputhje me IEC 60884-1, CEE7
- kontaktet e vidave 1,5-2,5 mm²
- kontaktet me rrymën të mbuluara

SOCKET EURO+KS 2P 10A 250V~ 1M

- 2P Euro
- 10A 250V~, type VM20
- in accordance with IEC 60884-1, CEE7
- screw contacts 1.5-2.5 mm²
- shuttered live contacts

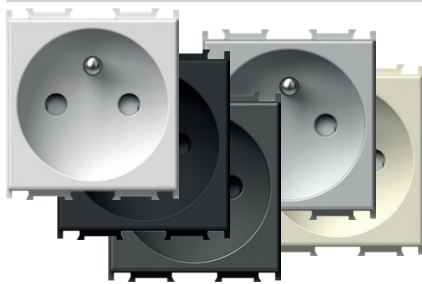

- VM40PW
- VM40MW
- VM40SB
- VM40AT
- VM40ES
- VM40IW

PRIZË FRANCEZE+KS 2P+E 16 A 250 V~ 2M

- 2P+E Franceze
- 16 A 250 V~, lloji VM40
- në përputhje me IEC 60884-1, NF C 61-314, CEE7
- kontaktet e vidave 1,5-2,5 mm²
- kontaktet me rrymën të mbuluara

SOCKET FRENCH+KS 2P+E 16A 250V~ 2M

- 2P+E French
- 16A 250V~, type VM40
- in accordance with IEC 60884-1, NF C 61-314, CEE7
- screw contacts 1.5-2.5 mm²
- shuttered live contacts

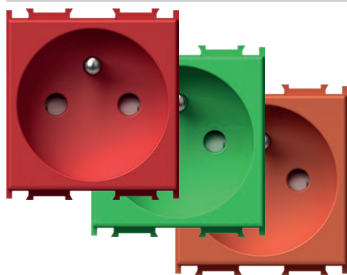

- VM40RD
- VM40GR
- VM40OR

PRIZË FRANCEZE+KS 2P+E 16 A 250 V~ 2M

- 2P+E Franceze
- 16 A 250 V~, lloji VM40
- në përputhje me IEC 60884-1, NF C 61-314, CEE7
- kontaktet e vidave 1,5-2,5 mm²
- kontaktet me rrymën të mbuluara

SOCKET FRENCH+KS 2P+E 16A 250V~ 2M

- 2P+E French
- 16A 250V~, type VM40
- in accordance with IEC 60884-1, NF C 61-314, CEE7
- screw contacts 1.5-2.5 mm²
- shuttered live contacts



- VM41PT
- VM41MT
- VM41BT
- VM41AT
- VM41PP
- VM41ST
- VM41IT

PRIZË FRANCEZE+KS+KAPAK 2P+E 16 A 250 V~ 2M

- 2P+E Franceze+kapak
- 16 A 250 V~, lloji VM41
- në përputhje me IEC 60884-1, NF C 61-314, CEE7
- kontaktet e vidave 1,5-2,5 mm²
- kontaktet me rrymën të mbuluara

SOCKET FRENCH+KS+COVER

- 2P+E 16A 250V~ 2M
- 2P+E French+cover
- 16A 250V~, type VM41
- in accordance with IEC 60884-1, NF C 61-314, CEE7
- screw contacts 1.5-2.5 mm²
- shuttered live contacts

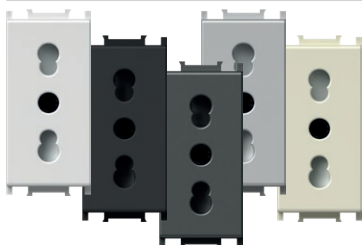

- VM30PW
- VM30MW
- VM30SB
- VM30AT
- VM30ES
- VM30IW

PRIZË ITALIANE P17/11+KS 2P+E 16 A 250 V~ 1M

- 2P+E Italiane P17/11
- 16 A 250 V~, lloji VM30
- në përputhje me IEC 60884-1, CEI 23-50
- kontaktet e vidave 1,5-2,5 mm²
- kontaktet me rrymën të mbuluara

SOCKET ITALIAN P17/11+KS 2P+E 16A 250V~ 1M

- 2P+E Italian P17/11
- 16A 250V~, type VM30
- in accordance with IEC 60884-1, CEI 23-50
- screw contacts 1.5-2.5 mm²
- shuttered live contacts

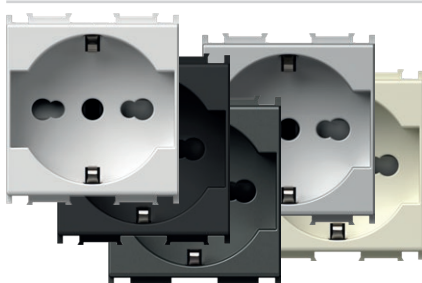

- VM31PW
- VM31MW
- VM31SB
- VM31AT
- VM31ES
- VM31IW

PRIZË SCHUKO/ITALIANE P17/11+KS 2P+E 16 A 250 V~ 2M

- 2P+E Schuko/Italiane P17/11
- 16 A 250 V~, lloji VM31
- në përputhje me IEC 60884-1, CEI 23-50
- kontaktet e vidave 1,5-2,5 mm²
- kontaktet me rrymën të mbuluara

SOCKET SCHUKO/ITA P17/11+KS

- 2P+E 16A 250V~ 2M
- 2P+E schuko/Italian P17/11
- 16A 250V~, type VM31
- in accordance with IEC 60884-1, CEI 23-50
- screw contacts 1.5-2.5 mm²
- shuttered live contacts

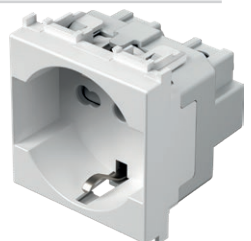

PRIZË SCHUKO/ITALIANE P30+KS 2P+E 16 A 250 V~ 2M

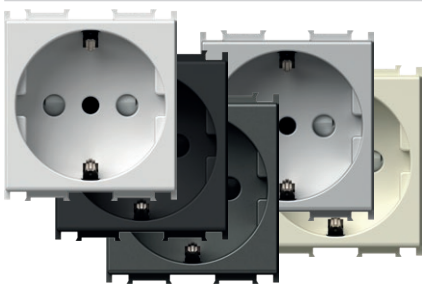

- VM32PW
- VM32MW
- VM32SB
- VM32AT
- VM32ES
- VM32IW

- 2P+E Schuko/Italiane P30
- 16 A 250 V~, Iloji VM32
- në përputhje me IEC 60884-1, CEI 23-50
- kontaktet e vidave 1,5-2,5 mm²
- kontaktet me rrymën të mbuluara



SOCKET SCHUKO/ITA P30+KS 2P+E 16A 250V~ 2M

- 2P+E schuko/Italian P30
- 16A 250V~, type VM32
- in accordance with IEC 60884-1, CEI 23-50
- screw contacts 1.5-2.5 mm²
- shuttered live contacts

PRIZË ITALIANE P11+KS 2P+E 10A 250 V~ 1M

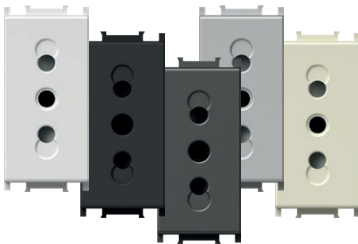

- VM33PW
- VM33MW
- VM33SB
- VM33AT
- VM33ES
- VM33IW

- 2P+E Italiane P11
- 10A 250 V~, Iloji VM33
- në përputhje me IEC 60884-1, CEI 23-50
- kontaktet e vidave 1,5-2,5 mm²
- kontaktet me rrymën të mbuluara



SOCKET ITALIAN P11+KS 2P+E 10A 250V~ 1M

- 2P+E Italian P11
- 10A 250V~, type VM33
- in accordance with IEC 60884-1, CEI 23-50
- screw contacts 1.5-2.5 mm²
- shuttered live contacts

PRIZË EURO/AMERIKANE+KS 2P 16A 250 V~ 1M

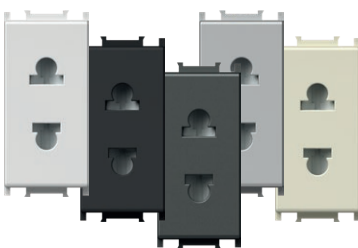

- VM21PW
- VM21MW
- VM21SB
- VM21AT
- VM21ES
- VM21IW

- 2P Euro/Amerikane
- 16 A 250 V~, Iloji VM21
- kontaktet e vidave 1,5-2,5 mm²
- kontaktet me rrymën të mbuluara
- vetëm për vendet jashtë BE-së



SOCKET EURO/AMERICAN+KS 2P 16A 250V~ 1M

- 2P Euro/American
- 16A 250V~, type VM21
- screw contacts 1.5-2.5 mm²
- shuttered live contacts
- only for countries not members of EU

PRIZË BRITANIKE BS 1363-2+KS 2P+E 13 A 250 V~ 2M

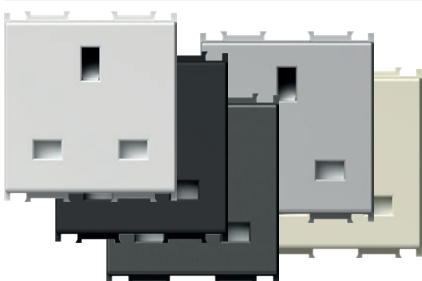

- VM52PW
- VM52MW
- VM52SB
- VM52AT
- VM52ES
- VM52IW

- 2P+E Britanike BS 1363-2
- 13 A 250 V~, Iloji VM52
- në përputhje me BS 1363-2
- kontaktet e vidave 1,5-4 mm²
- kontaktet me rrymën të mbuluara

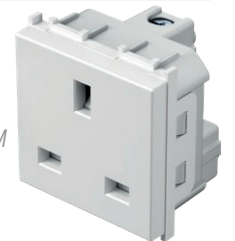

SOCKET BRITISH BS 1363-2+KS 2P+E 13A 250V~ 2M

- 2P+E British BS 1363-2
- 13A 250V~, type VM52
- in accordance with BS 1363-2
- screw contacts 1.5-4 mm²
- shuttered live contacts

PRIZA MULTISTANDARDE+KS 2P+E 13A 250V~ 2M

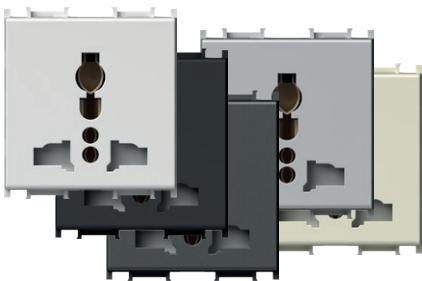

- VM55PW
- VM55MW
- VM55SB
- VM55AT
- VM55ES
- VM55IW

- kontakte spinash 1,5-2,5 mm²
- kontaktet me rrymën të mbuluara

SOCKET MULTI-STANDARD+KS 2P+E 13A 250V~ 2M

- plug-in contacts 1.5-2.5 mm²
- shuttered live contacts



MBROJTËS NGA MBIRRYMA MPE MINI 275 V/50 Hz



VM80

- lidhje paralele me prizën e parë në radhë
- mbrojtje e klasit III
- Uc=275 V ac, Uoc/Isc=6 kV/3 kA, Up<800 V
- në përputhje me IEC 61643-1
- telat 1,5 mm², IP20
- sinjalistik gjatë shkëputjes





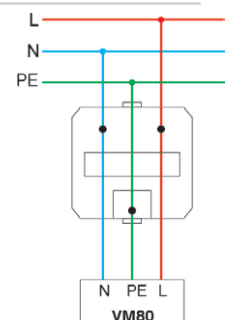





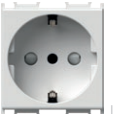

SURGE PROTECTOR MPE MINI 275V/50Hz

- parallel connection with the first socket in the row
- protection class III
- Uc=275Vac, Uoc/Isc=6kV/3kA, Up<800V
- in accordance with IEC 61643-1
- wires 1.5mm², IP20
- sound signal at breakdown







S O C K E T S V M

PËRSHTATJE E PRIZAVE DHE SPINAVE
SOCKETS AND PLUGS MATCHING

PRIZA / SOCKET									
LLOJI I SPINËS / PLUG STYLE	VM10 VM11	VM20	VM30	VM33	VM31	VM32	VM40 VM41	VM21	VM55
Gjermane / German 	•				•	•			•
Franceze / French 	•				•	•	•		•
Italiene / Italian S11 			•	•	•	•			•
Italiene / Italian S17 			•		•				•
Euro 	•	•	•		•	•	•	•	•

PËRSHTATJE E PRIZAVE DHE SPINAVE
SOCKETS AND PLUGS MATCHING

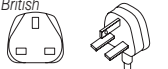
PRIZA / SOCKET			
LLOJI I SPINËS / PLUG STYLE	VM21	VM52	VM55
Amerikane / American 	•		•
Britanike / British BS 1363-2 		•	•

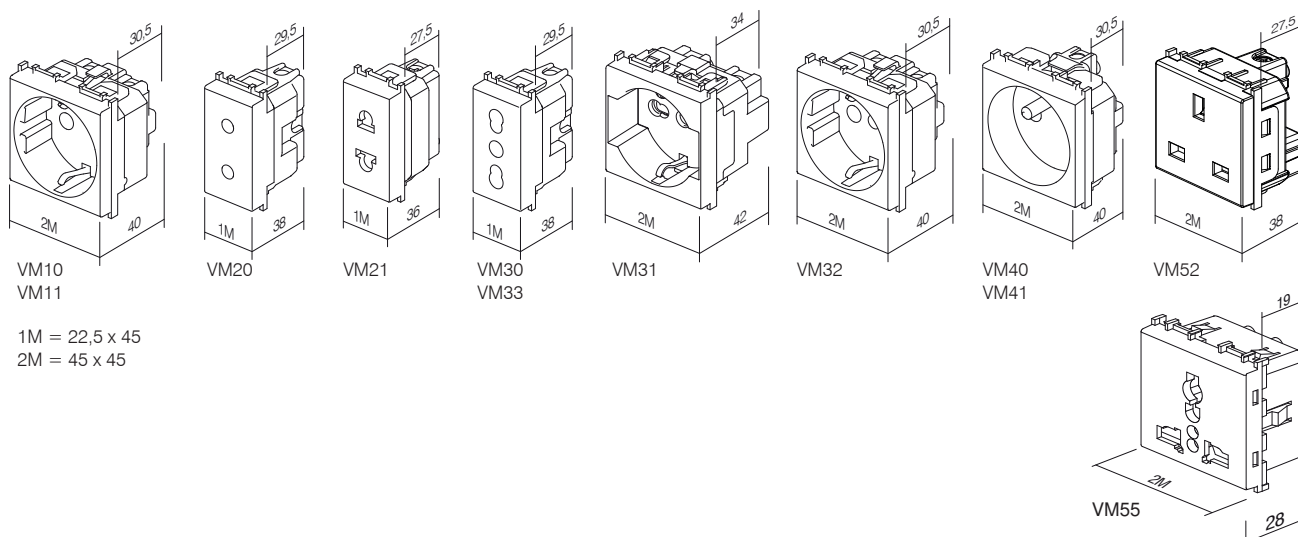



Iloji type	përshkrimi description	të dhënat teknike technical data	madhësia size	ngjyra colour
KM10	PRIZË TV BAZË SOCKET TV BASIC	0dB	1M	<input type="checkbox"/> PW e bardhë polare polar white
KM11	PRIZË TV ME KAPAK FUNDOR SOCKET TV END-LINE	1dB	1M	<input type="checkbox"/> MW e bardhë mat matte white
KM12	PRIZË TV KALUESE SOCKET TV TROUGHPASS	10dB	1M	<input checked="" type="checkbox"/> SB e zezë soft touch soft touch black
:	:	:	:	<input type="checkbox"/> AT antracit anthracite
:	:	:	:	<input type="checkbox"/> ES e argjendtë elox elox silver
:	:	:	:	<input type="checkbox"/> IW e bardhë fildishi ivory white

PRIZË TV BAZË 0dB 1M



- KM10PW
- KM10MW
- KM10SB
- KM10AT
- KM10ES
- KM10IW

- TV bazë
 - reduktim 0dB
 - lidhje e pasme – F standarde
- SOCKET TV BASIC 0dB 1M*
- TV basic
 - reduction 0dB
 - back connector – F standard



PRIZË TV BAZË 0dB 2M

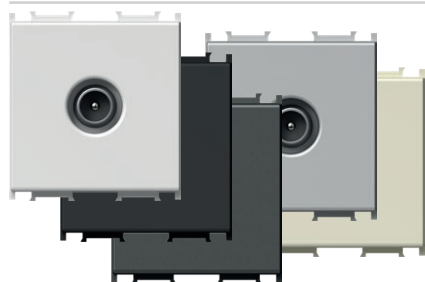

- KM20PW
- KM20MW
- KM20SB
- KM20AT
- KM20ES
- KM20IW

- TV bazë
 - reduktim 0dB
 - lidhje e pasme – F standarde
- SOCKET TV BASIC 0dB 2M*
- TV basic
 - reduction 0dB
 - back connector – F standard



PRIZË TV ME KAPAK FUNDOR 1dB 1M



- KM11PW
- KM11MW
- KM11SB
- KM11AT
- KM11ES
- KM11IW

- TV me kapak fundor
 - gama e frekuencës 5÷2400 MHz
 - reduktimi < 1 dB
 - në përputhje me EN 50083-1
 - kontaktet e vidave
- SOCKET TV END-LINE 1dB 1M*
- TV end-line
 - frequency range 5÷2400 MHz
 - reduction < 1 dB
 - in accordance with EN 50083-1
 - screw contacts

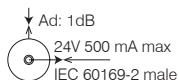

PRIZË TV KALUESE 10dB 1M

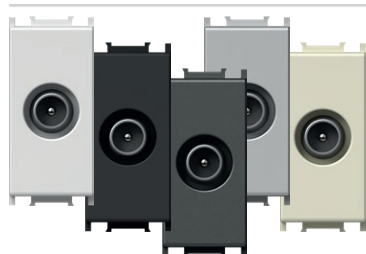

- KM12PW
- KM12MW
- KM12SB
- KM12AT
- KM12ES
- KM12IW

- TV kaluese
 - gama e frekuencës 5÷2400 MHz
 - reduktimi < 10 dB
 - në përputhje me EN 50083-1
 - kontaktet e vidave
- SOCKET TV TROUGHPASS 10dB 1M*
- TV troughpass
 - frequency range 5÷2400 MHz
 - reduction < 10 dB
 - in accordance with EN 50083-1
 - screw contacts

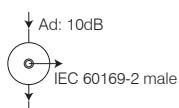

PRIZË SAT BAZË 0dB 1M



- KM15PW
- KM15MW
- KM15SB
- KM15AT
- KM15ES
- KM15IW

- SAT bazë
- reduktim 0dB
- lidhje e pasme – F standarde
- SOCKET SAT BASIC 0dB 1M*
- SAT basic
- reduction 0dB
- back connector – F standard



PRIZË SAT BAZË 0dB 2M

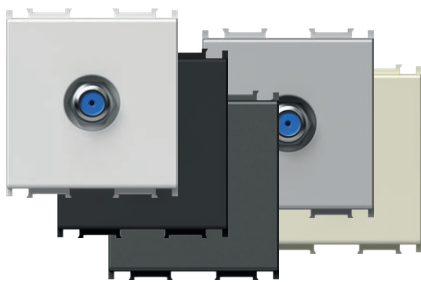

- KM24PW
- KM24MW
- KM24SB
- KM24AT
- KM24ES
- KM24IW

- SAT bazë
- reduktim 0dB
- lidhje e pasme – F standarde
- SOCKET SAT BASIC 0dB 2M*
- SAT basic
- reduction 0dB
- back connector – F standard



PRIZË SAT ME KAPAK FUNDOR 1dB 1M

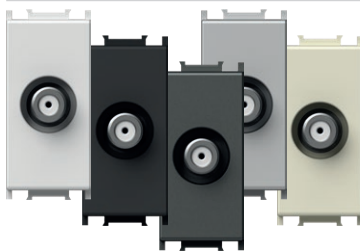

- KM16PW
- KM16MW
- KM16SB
- KM16AT
- KM16ES
- KM16IW

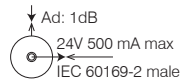

- SAT me kapak fundor
- gama e frekuencës 5÷2400 MHz
- reduktim < 0dB
- në përputhje me EN 50083-1
- kontaktet e vidave
- SOCKET SAT END-LINE 1dB 1M*
- SAT end-line
- frequency range 5÷2400 MHz
- reduction < 1dB
- in accordance with EN 50083-1
- screw contacts



PRIZË R BAZË 0dB 1M



- KM19PW
- KM19MW
- KM19SB
- KM19AT
- KM19ES
- KM19IW

- R bazë
- reduktim 0dB
- lidhje e pasme – F standarde
- SOCKET R BASIC 0dB 1M*
- R basic
- reduction 0dB
- back connector – F standard



PRIZË R BAZË 0dB 2M

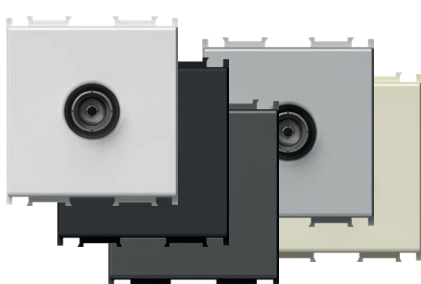

- KM29PW
- KM29MW
- KM29SB
- KM29AT
- KM29ES
- KM29IW

- R bazë
- reduktim 0dB
- lidhje e pasme – F standarde
- SOCKET R BASIC 0dB 2M*
- R basic
- reduction 0dB
- back connector – F standard



PRIZË SAT-TV ME KAPAK FUNDOR 1dB 2M



- KM25PW
- KM25MW
- KM25SB
- KM25AT
- KM25ES
- KM25IW

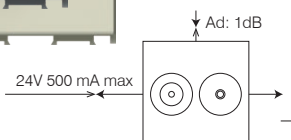

- SAT-TV me kapak fundor
- gama e frekuencës 5÷2400 MHz
- reduktim < 0dB
- në përputhje me EN 50083-1
- kontaktet e vidave
- SOCKET SAT-TV END-LINE 1dB 2M*
- SAT-TV end-line
- frequency range 5÷2400 MHz
- reduction < 1dB
- in accordance with EN 50083-1
- screw contacts



SHEMBUJ TË LIDHJEVE BAZË
BASIC CONNECTION SAMPLES

lidhje individuale
stand alone connection



KM10
KM20
KM11
KM15
KM24
KM16
KM19
KM29
KM25

lidhje yll
star connection

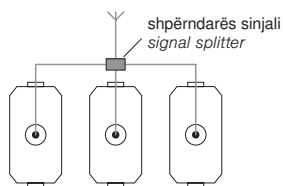

KM10
KM20
KM11
KM15
KM24
KM16
KM19
KM29
KM25

lidhje kaluese
throughpass connection

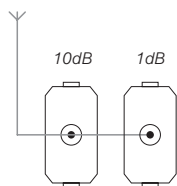

KM12 KM11



- KM22PW
- KM22MW
- KM22SB
- KM22AT
- KM22ES
- KM22IW

PRIZË AUDIO 2xRCA 1M

- audio 2x RCA
- lidhje me ngjitje e kablos në pjesën e pasme

SOCKET AUDIO 2xRCA 1M

- audio 2x RCA
- soldering connection of cable at the back side



- KM23PW
- KM23MW
- KM23SB
- KM23AT
- KM23ES
- KM23IW

PRIZË AUDIO ALTOPARLANTË 1M

- audio 2x Ø4mm
- për të mbajtur telin e altoparlantit, spinë banane Ø4mm ose pirun
- lidhje me ngjitje e kablos në pjesën e pasme

SOCKET AUDIO LOUDSPEAKERS 1M

- audio 2x Ø4mm
- to accommodate speaker wire, banana plug Ø4mm or spades
- soldering connection of cable at the back side



- KM26PW
- KM26MW
- KM26SB
- KM26AT
- KM26ES
- KM26IW

PRIZË AUDIO ALTOPARLANTË 2M

- audio 2x Ø4mm
- për të mbajtur telin e altoparlantit, spinë banane Ø4mm ose pirun
- lidhje me ngjitje e kablos në pjesën e pasme

SOCKET AUDIO LOUDSPEAKERS 2M

- audio 2x Ø4mm
- to accommodate speaker wire, banana plug Ø4mm or spades
- soldering connection of cable at the back side



1M = 22,5 x 45
2M = 45 x 45

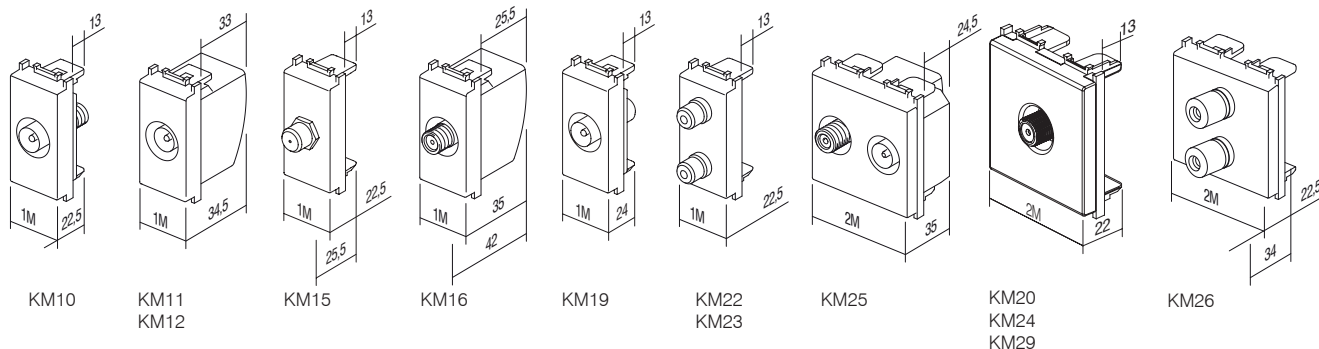

PRIZË TEL LT RJ11 6/4 1M



- KM30PW
- KM30MW
- KM30SB
- KM30AT
- KM30ES
- KM30IW

- vidë TEL LT
- RJ11 6/4
- në përputhje me IEC 60603-7
- kontaktet e vidave

SOCKET TEL LT RJ11 6/4 1M

- TEL LT screw
- RJ11 6/4
- in accordance with IEC 60603-7
- screw contacts



PRIZË TEL BT SEC 6/6 1M

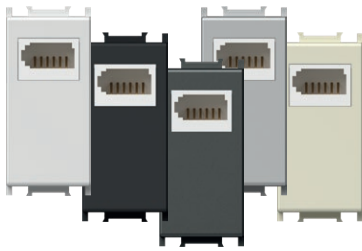

- KM31PW
- KM31MW
- KM31SB
- KM31AT
- KM31ES
- KM31IW

- TEL BT Britanike standarde
- SEC dytësore 6/6
- në përputhje me BS 6312
- kontaktet e vidave

SOCKET TEL BT SEC 6/6 1M

- TEL BT British standard
- SEC secondary 6/6
- in accordance with BS 6312
- screw contacts



PRIZË TEL KS RJ11 6/4 1M

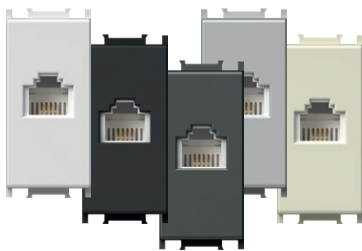

- KM36PW
- KM36MW
- KM36SB
- KM36AT
- KM36ES
- KM36IW

- standard fiksues trapez KS
- RJ11 6/4
- në përputhje me IEC 60603-7

SOCKET TEL KS RJ11 6/4 1M

- KS keystone fixing standard
- RJ11 6/4
- in accordance with IEC 60603-7

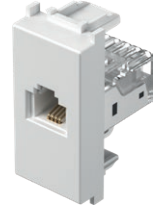

PRIZË CAT5e KS RJ45 8/8 1M

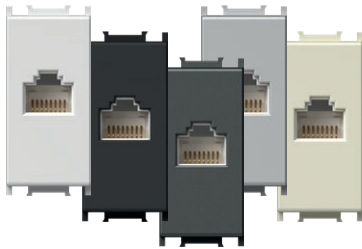

- KM37PW
- KM37MW
- KM37SB
- KM37AT
- KM37ES
- KM37IW

- standard fiksues trapez KS
- CAT5e, RJ45 8/8
- në përputhje me IEC 60603-7

SOCKET CAT5e KS RJ45 8/8 1M

- KS keystone fixing standard
- CAT5e, RJ45 8/8
- in accordance with IEC 60603-7

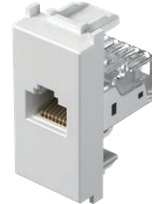

PËRSHTATËS KS 1M

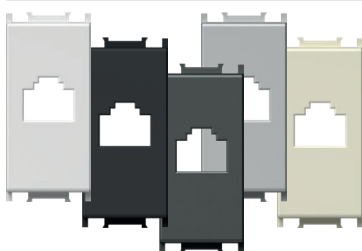

- KM35PW
- KM35MW
- KM35SB
- KM35AT
- KM35ES
- KM35IW

- standard fiksues trapez KS
- AMP, Avaya, Brandrex, FMT, Mfico, Tyco, ...
- moduli i komunikimit nuk përfshihet

ADAPTER KS 1M

- KS keystone fixing standard
- AMP, Avaya, Brandrex, FMT, Mfico, Tyco, ...
- communication module not included



PËRSHTATËS KS ME MBROJTJE NGA PLUHURI 1M

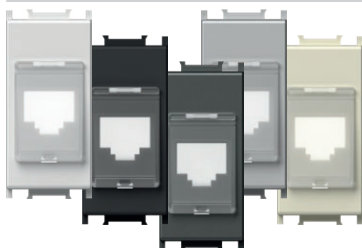

- KM38PW
- KM38MW
- KM38SB
- KM38AT
- KM38ES
- KM38IW

- standard fiksues trapez KS me mbrojtje nga pluhuri
- AMP, Avaya, Brandrex, FMT, Mfico, Tyco, ...
- moduli i komunikimit nuk përfshihet

ADAPTER KS WITH DUST PROTECTION 1M

- KS keystone fixing standard with dust protection
- AMP, Avaya, Brandrex, FMT, Mfico, Tyco, ...
- communication module not included



PRIZË CAT6 SCH KS RJ45 8/8 1M

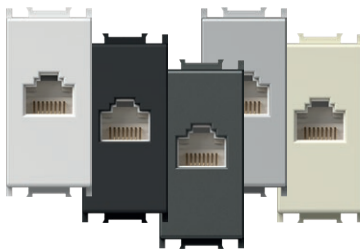

- KM39PW
- KM39MW
- KM39SB
- KM39AT
- KM39ES
- KM39IW

- standard fiksues trapez KS
- CAT6 UTP pa vegla, RJ45 8/8
- në përputhje me ISO/IEC 11801

SOCKET CAT6 SCH KS RJ45 8/8 1M

- KS keystone fixing standard
- CAT6 UTP toolless, RJ45 8/8
- in accordance with ISO/IEC 11801

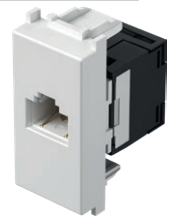

PËRSHTATËS KS UNIVERSAL 1M

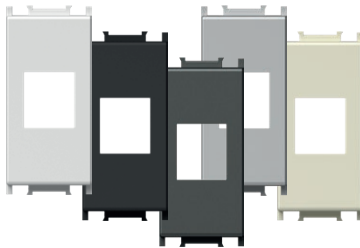

- KM50PW
- KM50MW
- KM50SB
- KM50AT
- KM50ES
- KM50IW

- standard fiksues trapez KS
- i përshtatshëm për HDMI, USB
- moduli i komunikimit nuk përfshihet

ADAPTER KS UNIVERSAL 1M

- KS keystone fixing standard
- suitable for HDMI, USB
- communication module not included



PËRSHTATËS PD 1M



- KM40PW
- KM40MW
- KM40SB
- KM40AT
- KM40ES
- KM40IW

- standard fiksues PD Panduit Mini-COM
- moduli i komunikimit nuk përfshihet

ADAPTER PD 1M

- PD Panduit Mini-COM fixing standard
- communication module not included



PËRSHTATËS PD ME MBROJTJE NGA PLUHURI 1M



- KM43PW
- KM43MW
- KM43SB
- KM43AT
- KM43ES
- KM43IW

- standard fiksues PD Panduit Mini-COM me mbrojtje nga pluhuri
- moduli i komunikimit nuk përfshihet

ADAPTER PD WITH DUST PROTECTION 1M

- PD Panduit Mini-COM fixing standard with dust protection
- communication module not included



PËRSHTATËS R&M 1M

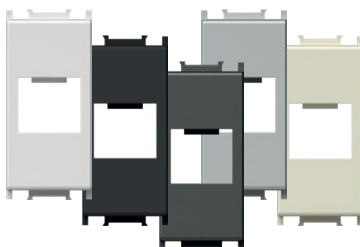

- KM46PW
- KM46MW
- KM46SB
- KM46AT
- KM46ES
- KM46IW

- standard fiksues R&M
- moduli i komunikimit nuk përfshihet

ADAPTER R&M 1M

- R&M fixing standard
- communication module not included



PËRSHTATËS R&M CAT6A 1M

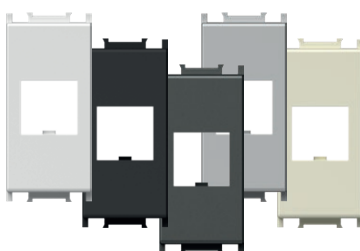

- KM52PW
- KM52MW
- KM52SB
- KM52AT
- KM52ES
- KM52IW

- fiksues R&M për CAT6A
- moduli i komunikimit nuk përfshihet

ADAPTER R&M CAT6A 1M

- R&M fixing for CAT6A
- communication module not included





- KM47PW
- KM47MW
- KM47SB
- KM47AT
- KM47ES
- KM47IW

PËRSHTATËS R&M ME MBROJTJE NGA PLUHURI 1M

- standard fiksues R&M me mbrojtje nga pluhuri
- moduli i komunikimit nuk përfshihet

ADAPTER R&M WITH DUST PROTECTION 1M

- R&M fixing standard with dust protection
- communication module not included



- KM53PW
- KM53MW
- KM53SB
- KM53AT
- KM53ES
- KM53IW

PËRSHTATËS R&M CAT6A ME MBROJTJE NGA PLUHURI 1M

- fiksues R&M për CAT6A me mbrojtje nga pluhuri
- moduli i komunikimit nuk përfshihet

ADAPTER R&M CAT6A WITH DUST PROTECTION 1M

- R&M fixing for CAT6A with dust protection
- communication module not included



PËRSHTATËS LK 1M

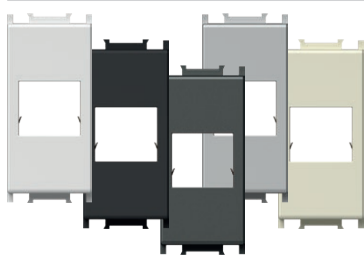

- KM45PW
- KM45MW
- KM45SB
- KM45AT
- KM45ES
- KM45IW

- standard fiksues LK LeoniKerpen eLine / BKS NewLine
- moduli i komunikimit nuk përfshihet

ADAPTER LK 1M

- LK LeoniKerpen eLine / BKS NewLine fixing standard
- communication module not included



PËRSHTATËS NEXANS/SCHRACK 2M

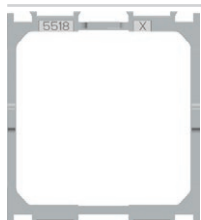

KA26

- përshtatës fiksues për Nexans LANmark dhe LANmark në Schrack velikosti 45x45 mm
- modul Schrack 45x45 mm
- e përshtatshme për Schrack llojin HSEMD02W2F
- moduli i komunikimit nuk përfshihet

ADAPTER NEXANS/SCHRACK 2M

- fixing adapter for Nexans LANmark and Schrack module 45x45mm
- suitable for Nexans type N423.540N
- suitable for Schrack type HSEMD02W2F
- communication module not included

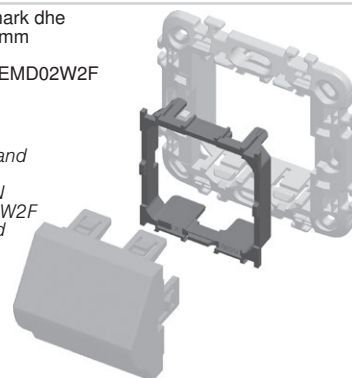

PËRSHTATËS AT&T SYSTIMAX ME MBROJTJE NGA PLUHURI 1M

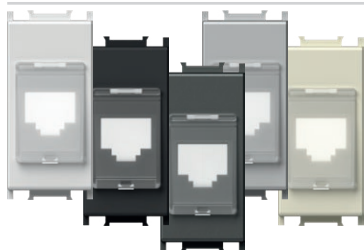

- KM48PW
- KM48MW
- KM48SB
- KM48AT
- KM48ES
- KM48IW

- standard fiksues AT&T Systemax me mbrojtje nga pluhuri
- moduli i komunikimit nuk përfshihet

ADAPTER AT&T SYSTIMAX WITH DUST PROTECTION 1M

- AT&T Systemax fixing standard with dust protection
- communication module not included



PRIZË USB LLOJI A 1M



- KM51PW
- KM51MW
- KM51SB
- KM51AT
- KM51ES
- KM51IW

- prizë USB 2.0 lloji A
- kontaktet e vidave, raster 5 mm, 1,5 mm², 1x2P + 1x3P
- lidhjet elektrike:
KUNJË 1 – VCC (+5V, teli i kuq)
KUNJË 2 – Të dhëna - (teli i bardhë)
KUNJË 3 – Të dhëna + (teli i gjelbër)
KUNJË 4 – GND - tokëzimi (teli i zi)
S – mbrojtja
- në përputhje me direktivën 2011/95/EU (RoHS2)

SOCKET USB TYPE A 1M

- USB 2.0 socket type A
- screw contacts, raster 5 mm, 1,5 mm², 1x2P + 1x3P
- wiring:
PIN 1 – VCC (+5V, red wire)
PIN 2 – Data - (white wire)
PIN 3 – Data + (green wire)
PIN 4 – GND - ground (black wire)
S – shield
- in accordance with directive 2011/95/EU (RoHS2)



1M = 22,5 x 45
2M = 45 x 45

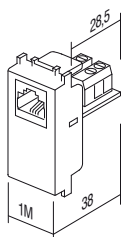

KM30

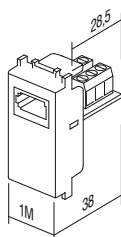

KM31

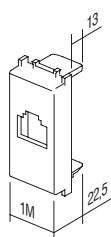

KM35
KM38
KM48

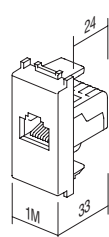

KM36
KM37
KM39

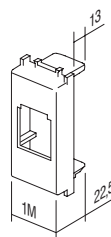

KM40
KM43

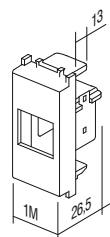

KM45

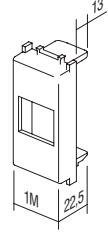

KM46
KM47
KM50
KM52
KM53

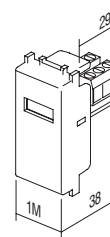

KM51



KA10

Iloji type	përshkrimi description	të dhënat teknike technical data
KA10	KONEKTORI KS CAT3 CONNECTOR KS CAT3	RJ11 6/4
KA11	KONEKTORI KS CAT5e CONNECTOR KS CAT5e	RJ45 8/8
KA12	KONEKTORI KS CAT5eS CONNECTOR KS CAT5eS	RJ45 8/8
...
		<p>KONEKTORI KS CAT3 RJ11 6/4</p> <ul style="list-style-type: none"> - standard fiksues trapez KS - CAT3, RJ11 6/4 - në përputhje me IEC 60603-7 <p><i>CONNECTOR KS CAT3 RJ11 6/4</i></p> <ul style="list-style-type: none"> - KS keystone fixing standard - CAT3, RJ11 6/4 - in accordance with IEC 60603-7
		<p>KONEKTORI KS CAT5e RJ45 8/8</p> <ul style="list-style-type: none"> - standard fiksues trapez KS - CAT5e, RJ45 8/8 - në përputhje me IEC 60603-7 <p><i>CONNECTOR KS CAT5e RJ45 8/8</i></p> <ul style="list-style-type: none"> - KS keystone fixing standard - CAT5e, RJ45 8/8 - in accordance with IEC 60603-7
		<p>KONEKTORI KS CAT5eS RJ45 8/8</p> <ul style="list-style-type: none"> - standard fiksues trapez KS - CAT5eS, RJ45 8/8 - në përputhje me IEC 60603-7 <p><i>CONNECTOR KS CAT5eS RJ45 8/8</i></p> <ul style="list-style-type: none"> - KS keystone fixing standard - CAT5eS, RJ45 8/8 - in accordance with IEC 60603-7
		<p>KONEKTORI KS CAT6 SCH RJ45 8/8</p> <ul style="list-style-type: none"> - standard fiksues trapez KS - CAT6 UTP pa vegla, RJ45 8/8 - në përputhje me ISO/IEC 11801 <p><i>CONNECTOR KS CAT6 SCH RJ45 8/8</i></p> <ul style="list-style-type: none"> - KS keystone fixing standard - CAT6 UTP toolless, RJ45 8/8 - in accordance with ISO/IEC 11801
		<p>KONEKTORI KS CAT6S SCH RJ45 8/8</p> <ul style="list-style-type: none"> - standard fiksues trapez KS - CAT6S STP pa vegla, RJ45 8/8 - në përputhje me ISO/IEC 11801 <p><i>CONNECTOR KS CAT6S SCH RJ45 8/8</i></p> <ul style="list-style-type: none"> - KS keystone fixing standard - CAT6S STP toolless, RJ45 8/8 - in accordance with ISO/IEC 11801
		<p>KONEKTORI KS CAT6a SCH RJ45 8/8</p> <ul style="list-style-type: none"> - standard fiksues trapez KS - CAT6a STP pa vegla, RJ45 8/8 - në përputhje me ISO/IEC 11801 <p><i>CONNECTOR KS CAT6a SCH RJ45 8/8</i></p> <ul style="list-style-type: none"> - KS keystone fixing standard - CAT6a STP toolless, RJ45 8/8 - in accordance with ISO/IEC 11801



KA18

KONEKTORI SLIM KS CAT6S SCH RJ45 8/8

- standard fiksues trapez KS
- stil slim
- CAT6S STP pa vegla, RJ45 8/8
- në përputhje me ISO/IEC 11801
- i përshtatshëm edhe për përshtatës dysh KE46

CONNECTOR SLIM KS CAT6S SCH RJ45 8/8

- KS keystone fixing standard
- slim style
- CAT6S STP toolless, RJ45 8/8
- in accordance with ISO/IEC 11801
- suitable also for KE46 double adapter



KA27

KONEKTORI KS HDMI

- standard fiksues trapez KS
- vetëm në kombinim me përshtatësin KM50
- HDMI/HDMI

CONNECTOR KS HDMI

- KS keystone fixing standard
- only in combination with adapter KM50
- HDMI/HDMI



KA28

KABLOJA KS HDMI

- standard fiksues trapez KS
- vetëm në kombinim me përshtatësin KM50
- HDMI/HDMI

CABLE KS HDMI

- KS keystone fixing standard
- only in combination with adapter KM50
- HDMI/HDMI



EM31



PW



Iloji type	përshkrimi description	të dhënat teknike technical data	madhësia size	ngjyra colour	
EM12	REOSTAT RROTULLUES/2 DREJTIME DIMMER ROTATIVE 2WAY	RL 300W	1M	<input type="checkbox"/> PW e bardhë polare polar white	<input type="checkbox"/> BL blu blue
EM23	REOSTAT ME MONTIM NË KUTI DIMMER INBOX	R (250 W), (RC,RL 200VA)	/	<input type="checkbox"/> MW e bardhë mat matte white	<input type="checkbox"/> RD e kuqe red
.	.	.	.	<input type="checkbox"/> SB e zezë soft touch soft touch black	<input type="checkbox"/> GR e gjelbër green
.	.	.	.	<input type="checkbox"/> AT antracit anthracite	<input type="checkbox"/> OR portokalli orange
.	.	.	.	<input type="checkbox"/> ES e argjendtë elox elox silver	<input type="checkbox"/> RG e kuqe/e gjelbër red/green
.	.	.	.	<input type="checkbox"/> IW e bardhë fildishi ivory white	

REOSTAT RROTULLUES/2 DREJTIME RL 300W 1M



- EM12PW
- EM12MW
- EM12SB
- EM12AT
- EM12ES
- EM12IW

- kontroll i rrotullimit me çelësin me 2 drejtime
- RL i ngarkesës, 40 W - 300 W
- tensioni i furnizimit, 230 V ~ 50 Hz
- është i mundur kombinimi i çelësit me 2 drejtime
- instalimi i disa njësive bashkë në një kuti lejohet vetëm nëse ngarkesa maksimale totale e tyre nuk tejkalon fuqinë maksimale të një reostati të vetëm
- një qark lejon përdorimin e vetëm një reostati
- nuk ka siguresë të integruar - duhet të përdoret siguresa e jashtme
- në përputhje me EN 60669-1
- kontaktet e vidave 1,5-2,5 mm²
- treguesi i integruar LED i nivelit të ndriçimit

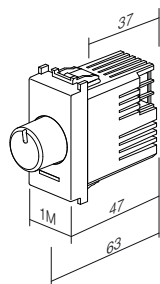

DIMMER ROTATIVE/2WAY RL 300W 1M

- rotation control with 2-way switch
- load RL, 40W - 300W
- supply voltage 230V ~ 50Hz
- 2-way switch combination is possible
- installing several devices together in one box is only permitted if their total maximum load does not exceed the maximum power of a single dimmer
- one circuit allows the use of only one dimmer
- no built-in fuse – external fuse must be used
- in accordance with EN 60669-1
- screw contacts - 1.5-2.5mm²
- integrated LED indication of dimming level

REOSTAT RROTULLUES/2 DREJTIME LED 60W 1M



- EM13PW
- EM13MW
- EM13SB
- EM13AT
- EM13ES
- EM13IW

- kontroll i rrotullimit me çelësin me 2 drejtime
- ngarkesat: LED, 0 – 60W (maks. 6 llamba LED me ulje ndriçimi)
GLS, 0 – 60 W
- tensioni i furnizimit, 230 V ~ 50 Hz
- është i mundur kombinimi i çelësit me 2 drejtime
- instalimi i disa njësive bashkë në një kuti lejohet vetëm nëse ngarkesa maksimale totale e tyre nuk tejkalon fuqinë maksimale të një reostati të vetëm
- një qark lejon përdorimin e vetëm një dimeri
- nuk ka siguresë të integruar - duhet të përdoret siguresa e jashtme
- në përputhje me EN-2-1
- kontaktet e vidave 1,5-2,5 mm²

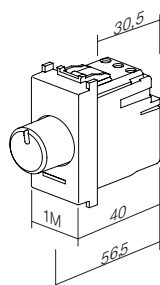
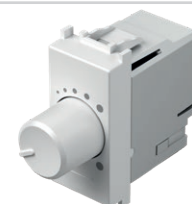

DIMMER ROTATIVE/2WAY LED 60W 1M

- rotation control with 2-way switch
- loads: LED, 0 – 60W (max. 6 dimmable LED lamps)
GLS, 0 – 60W
- supply voltage 230V ~ 50Hz
- 2-way switch combination is possible
- installing several devices together in one box is only permitted if their total maximum load does not exceed the maximum power of a single dimmer
- one circuit allows the use of only one dimmer
- no built-in fuse – external fuse must be used
- in accordance with IEC60669-2-1
- screw contacts - 1.5-2.5mm²

REOSTAT RROTULLUES/2 DREJTIME LED 180W 1M



- EM14PW
- EM14MW
- EM14SB
- EM14AT
- EM14ES
- EM14IW

- kontroll i rrotullimit me çelësin me 2 drejtime
- ngarkesat:
 - LED, 0 – 180 W (maks. 20 llamba LED me ulje ndrçimi)
 - GLS, 0 – 180 W
- tensioni i furnizimit, 230 V ~ 50 Hz
- është i mundur kombinimi i çelësit me 2 drejtime
- instalimi i disa njësive bashkë në një kuti lejohet vetëm nëse ngarkesa maksimale totale e tyre nuk tejkalon fuqinë maksimale të një reostati të vetëm
- një qark lejon përdorimin e vetëm një dimeri
- nuk ka siguresë të integruar - duhet të përdoret siguresa e jashtme
- në përputhje me EN-2-1
- kontaktet e vidave 1,5-2,5 mm²

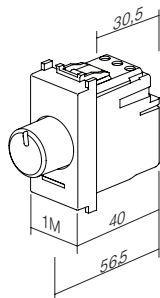

DIMMER ROTATIVE/2WAY LED 180W 1M

- rotation control with 2-way switch
- loads:
 - LED, 0 – 180W (max. 20 dimmable LED lamps)
 - GLS, 0 – 180W
- supply voltage 230V~ 50Hz
- 2-way switch combination is possible
- installing several devices together in one box is only permitted if their total maximum load does not exceed the maximum power of a single dimmer
- one circuit allows the use of only one dimmer
- no built-in fuse – external fuse must be used
- in accordance with IEC60669-2-1
- screw contacts - 1.5-2.5mm²

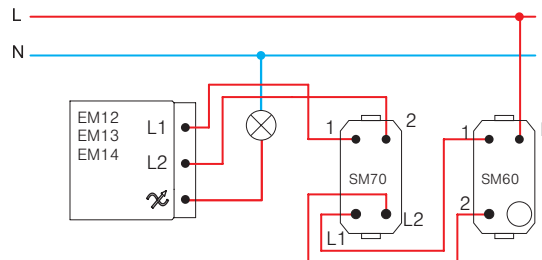
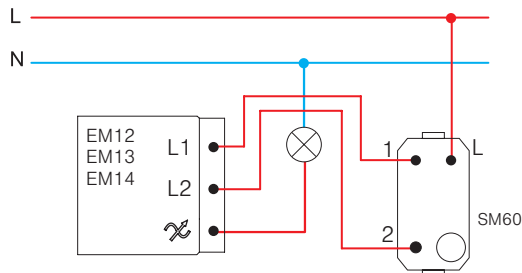
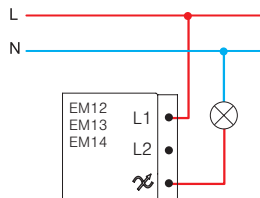

REOSTAT RROTULLUES R 250W 1M



- EM15PW
- EM15MW
- EM15SB
- EM15AT
- EM15ES
- EM15IW

- kontroll rrotullues pa çelës
- ngarkesa R, 40W - 250W
- tensioni i furnizimit, 230 V ~ 50 Hz
- nuk është i mundur kombinimi i çelësit me 2 drejtime
- nuk lejohet kombinimi i më shumë reostateve
- në përputhje me EN 60669-1
- kontaktet e vidave 1,5-2,5 mm²
- Treguesi LED

DIMMER ROTATIVE R 250W 1M

- rotation control without switch
- load R, 40W - 250W
- supply voltage 230V~ 50Hz
- 2-way switch combination is not possible
- more dimmers combination is not allowed
- in accordance with EN 60669-1
- screw contacts 1.5-2.5mm²
- LED indication

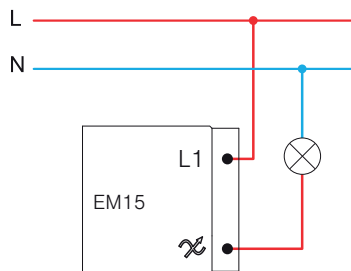
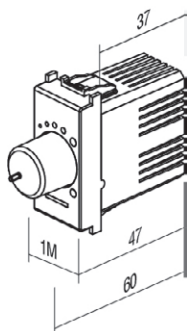



- EM16PW
- EM16MW
- EM16SB
- EM16AT
- EM16ES
- EM16IW

1-10 V ÇELËSI RROTULLJUES ME DY DREJTIME I REOSTATIT

- tensioni nominal i punës: 10 V DC
- tensioni minimal i punës: 0,7 VDC
- diapazoni i errësimit: 0,7 - 100% (në varësi të furnizimit me energji dhe të ngarkesës)
- rënia minimale e rrymës: 0,1 mA
- rënia maksimale e rrymës: 120 mA
- konsumi maksimal: 0,35 W
- mbrojtja nga mbitensioni: 15,8 V DC deri në 250 mA (jo e zëvendësueshme)
- rryma maksimale e impulsit: 3 A DC
- lloji i ngarkesës: 0-10 V, 1-10 V dhe PWM
- lloji i çelësit: mekanik: me shtypje për ndezje/fikje
- kablllo nul: nuk nevojitet
- tensioni nominal i funksionimit: 100-240 V AC, 50-60 Hz
- rryma maksimale e menjëhershme: 10 A
- rryma maksimale e punës: 8 A
- ngarkesa maksimale (në 230 VAC): 1800 VA (1800 x pf = maksimumi W)
- rezistenca e izolimit: > 100 MΩ në 250 VAC
- mbrojtja nga mbitensionet dhe mbrojtja nga qarku i shkurtër: 10 A, 350 V AC (jo e zëvendësueshme)
- këndi i rrotullimit: 270° ± 5°
- temperatura e punës: -5 deri në 40°C
- temperatura e ruajtjes: -30 deri në 80°C
- temperatura maksimale e strehimit: 65°C
- lagështia maksimale: 90% (pa kondensim)
- EMC dhe imuniteti: CISPR 15 (2008), IEC 61547
- LVD: IEC 60669-1:2017, IEC 60669-2-1:2015

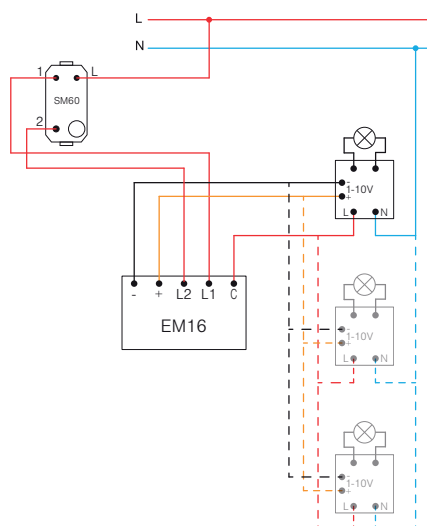
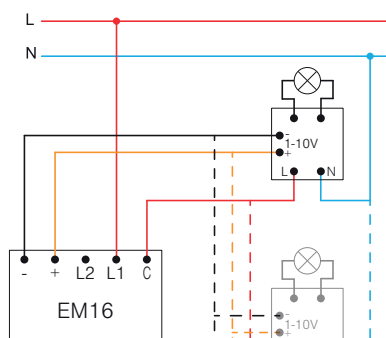
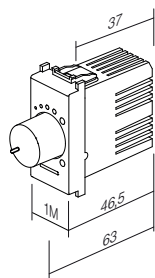

1-10 V DIMMER ROTARY TOGGLE

- nominal operating voltage: 10 VDC
- minimum operating voltage: 0.7 VDC
- dimming range: 0.7% - 100% (depending on power supply and loads)
- minimum sink current: 0.1 mA
- maximum sink current: 120 mA
- maximum consumption: 0.35 W
- surge protection: 15.8 VDC up to 250 mA (not replaceable)
- maximum pulse current: 3 ADC
- load types: 0-10 V, 1-10 V and PWM
- switch type: mechanical: push on/off
- zero cable: not required
- nominal operating voltage: 100-240 VAC, 50-60 Hz
- maximum instantaneous current: 10 A
- maximum operating current: 8 A
- maximum load (at 230 VAC): 1800 VA (1800 x pf = max. W)
- isolation resistance: > 100 MΩ at 250 VAC
- surge protection and Short-circuit protection: 10 A, 350 VAC (not replaceable)
- rotation angle: 270° ± 5°
- operating temperature: -5 to 40°C
- storing temperature: -30 to 80°C
- maximum housing temperature: 65°C
- maximum humidity: 90% (no condensation)
- EMC & immunity: CISPR 15(2008), IEC 61547
- LVD: IEC 60669-1:2017, IEC 60669-2-1:2015

REOSTAT ME MONTIM NË KUTI R (250 W), (RC, RL 200 VA)

EM23

- montim në kuti, me kontroll me buton të jashtëm me shtypje
- RLC me ngarkesë 15-250 W ose 15-200 VA
- tensioni i furnizimit, 230 V ~ 50 Hz
- janë të mundura disa kombinime të butonave me shtypje
- nuk lejohet kombinim i më shumë reostateve
- memorizim i intensitetit të dritës
- funksion ndezje/ndalim i butë
- »leading edge«
- në përputhje me EN60669, EN60950, EN 61000, ETSI EN 300 220-1, ETSI EN 300 220-2
- kontaktet e vidave me tela 2,5 mm²

DIMMER INBOX R (250 W), (RC, RL 200 VA)

- inbox, controlled by external push button
- load RLC 15-250W or 15-200 VA
- supply voltage 230V ~ 50Hz
- several push-buttons combinations are possible
- more dimmers combination is not allowed
- light intensity memory
- soft start/stop function
- »leading edge«
- in accordance with EN60669, EN60950, EN 61000, ETSI EN 300 220-1, ETSI EN 300 220-2
- screw contacts to wires 2,5 mm²

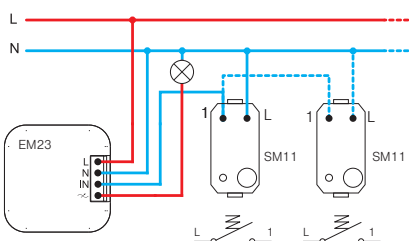
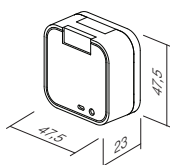

Moduli I KONTROLLIT MZC për EM18

EM17

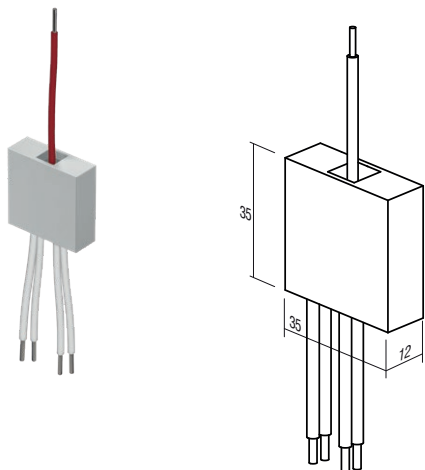

- Lidh MZC sipas diagramit të instalimit elektrik.
- Instalim i mundshëm elektrik me disa butona.
- Vetëm një instalim pajisjeje për kuti montimi.
- Vetëm për përdorim të brendshëm.
- Furnizimi i energjisë: 230 V~ 50 Hz
- Rezistenca maksimale e kablos: 50 kΩ
- Rryma maksimale për njësi MZC: 10 mA
- Numri i pajisjeve të ndriçimit në MZC: 1-4
- Numri maksimal i MZC në instalimin elektrik: i kufizuar me siguresën e shkri shme në qark
- Temperatura e funksionimit: -5°C deri në 45°C
- Temperatura e ruajtjes: -30°C deri në 80°C
- Lagështia maksimale: 90% (pa kondensim)
- Përmasat e kasës: 36x36x12 mm

MZC CONTROL Module for EM18

- Connect the MZC according to the wiring diagram.
- Possible wiring with several push buttons.
- Only one device installation per mounting box.
- For indoor use only.
- Power supply: 230V~ 50Hz
- Max. cable resistance: 50kΩ
- Max. current per MZC unit: 10mA
- Number of dimmers on MZC: 1-4
- Max. number of MZC in the wiring: limited to the fuse in the circuit
- Operating temperature: -5°C to 45°C
- Storage temperature: -30°C to 80°C
- Max. humidity: 90% (no condensation)
- Casing dimensions: 36x36x12 mm

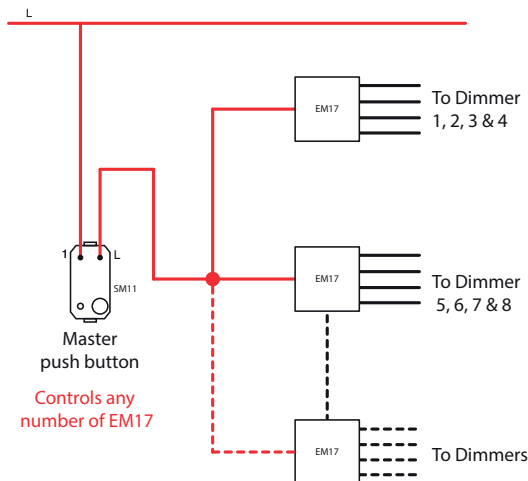
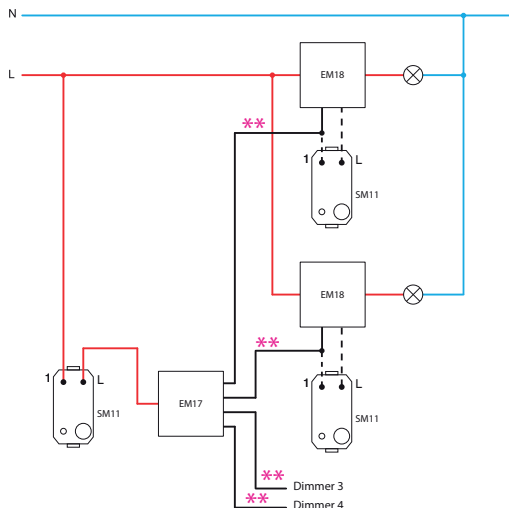

REOSTAT ME MONTIM NË KUTI LED 250 W

EM18

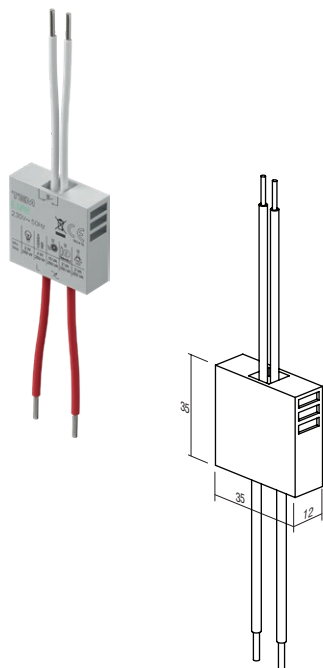

- montim në kuti, me kontroll me buton të jashtëm me shtypje
- për anën e përparme ose fundore
- tensioni i furnizimit, 230 V ~ 50 Hz
- janë të mundura disa kombinime të butonave me shtypje
- funksioni i memories së cilësimit të fundit, me përjashtim të rastit të ndërprerjes së energjisë
- funksioni i ndezjes/ndalimit të butë
- kontrolli i intensitetit minimal
- vetëm një reostat për kuti muri
- vetëm për përdorim të brendshëm
- në përputhje me standardet EN 60669-1 dhe EN 60669-2-1

DIMMER INBOX LED 250W

- inbox, controlled by external push button
- for leading or trailing edge
- supply voltage 230V~ 50Hz
- several push-buttons combinations is possible
- memory function of the last setting, except in the case of a power failure
- soft start / stop function
- minimum intensity control
- only one dimmer per wall box
- only for indoor usage
- in accordance with EN 60669-1 and EN 60669-2-1

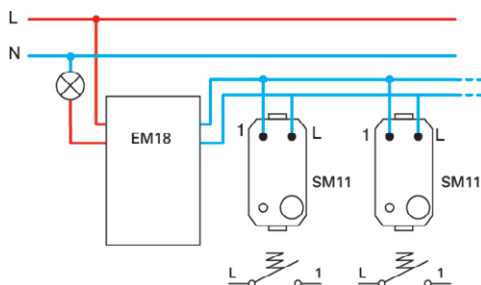

REOSTAT ME MONTIM NË KUTI DC LED 96 W

EM19

- montim në kuti, me kontroll me buton të jashtëm me shtypje
- për përdorim me drajverë për LED me tension konstant dhe disa drajverë për LED me rrymë konstante, 9-48 V DC, maks. 96 W (edhe për shiritat LED)
- jo për përdorim me ngarkesa me induksion
- janë të mundura kombinime të disa butonave me shtypje dhe disa reostateve
- funksioni i memories së cilësimit të fundit, me përjashtim të rastit të ndërprerjes së energjisë
- funksioni i ndezjes/ndalimit të butë
- vetëm një reostat për kuti muri
- vetëm për përdorim të brendshëm

DIMMER INBOX DC LED 96W

- inbox, controlled by external push button
- for use with constant voltage LED drivers and some constant current LED drivers, 9-48V DC, max 96W (also for LED strips)
- not for use with inductive loads
- several push-buttons combinations and several dimmers is possible
- memory function of the last setting, except in the case of a power failure
- soft start / stop function
- only one dimmer per wall box
- only for indoor usage

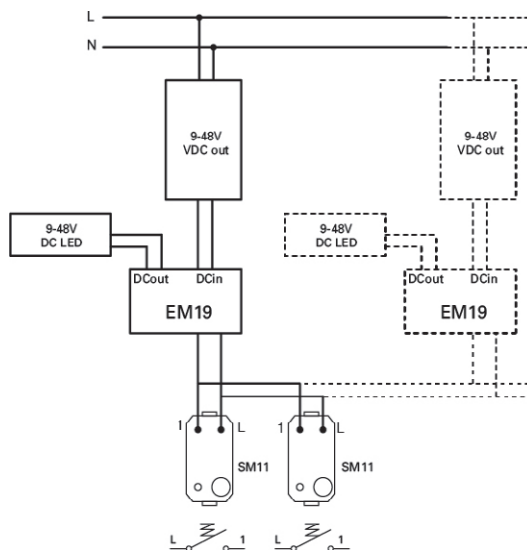
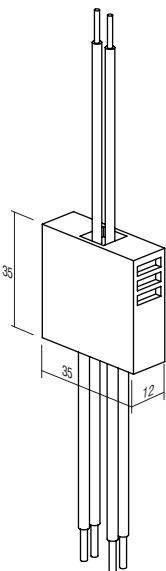

KUJDES!

Nëse lidhen më shumë reostatë në një kuti, reduktoni fuqinë e përbashkët me 10% për secilin reostat.

ATTENTION!

If more dimmers are connected in one box reduce maximum common power for 10% for each dimmer.

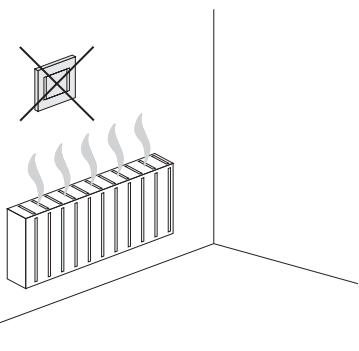

EM15 (40÷250W)

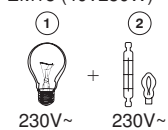

EM12 (40÷300W)

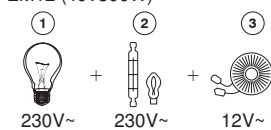

EM13 (0÷60W), EM14 (0÷180W), EM23 (15÷250W, 15÷200VA),

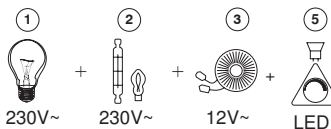

EM18 (2÷250VA)

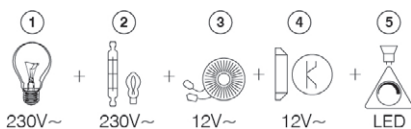

- 1 - llambë inkandeshente / incandescent lamp
- 2 - llambë halogjene / halogen lamp
- 3 - transformator klasik / classical transformer
- 4 - transformator elektrik me dimer / dimmable electronic transformer
- 5 - llambë LED me ulje ndriçimi / dimmable LED lamp

ÇELËS / REOSTAT UNIVERSAL RLC 0-300W 2M

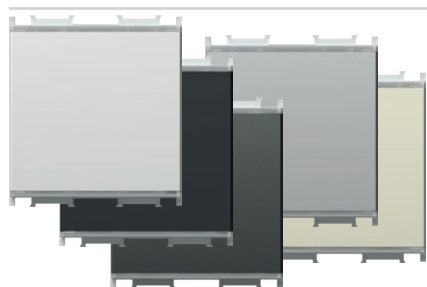

- EM25PW
- EM25MW
- EM25SB
- EM25AT
- EM25ES
- EM25IW

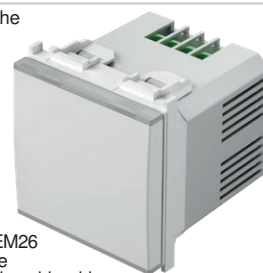

- reostat universal elektronik për NDEZJE/FIKJE dhe ulje ndriçimi të të gjitha llambave me ulje ndriçimi (klasike, halogjene, LED, CFL, ...) dhe disa llambave pa ulje ndriçimi
- zbulim automatik i llojit të llambës dhe rregullimit të regjimit të funksionimit
- reduktim i konsumit të energjisë
- funksioni i ndezjes së butë zgjat jetëgjatësinë e llambave
- kontrolluar me mikro çelësa të integruar
- funksioni i memorizimit i përfshirë – memorizon ndriçimin në ndezje
- mund të lidhen deri në pesë (5) njësi kontrolli shtesë EM26
- nuk është e mundur lidhja me çelës me 2 drejtime
- qark i shkurtër i integruar, mbrojtje nga mbingarkesa dhe mbinxehja
- tensioni i furnizimit, 230 V ~ 50 Hz
- një tregues elegant LED i integruar me opsionin e caktimit të ngjyrave dhe intensitetit.
- është i mundur zëvendësimi i çelësit klasik në lidhjen me dy tela (1)
- funksionimi i plotë arrihet në lidhjen me tre tela (2)
- në përputhje me standardet EN 60669-1 dhe EN 60669-2-1
- kontaktet e vidave 1,5mm² (forca maks. e shtrëngimit 0,4 Nm)

TOUCH EM25 është një reostat elektronik ndriçimi i kontrolluar me mikroprocesor. Ai shërben si çelës dhe reostat për llambat me ulje ndriçimi dhe disa llamba pa ulje ndriçimi. Mikroprocesori i integruar identifikon automatikisht llojin e llambës dhe rregullon regjimin e funksionimit. Ai memorizon nivelin e uljes së ndriçimit pas fikjes falë funksionit të integruar të memorizimit. Funksioni i ndezjes së butë zgjat jetëgjatësinë e llambës. Një tregues elegant LED është integruar në buton dhe ofrohet opsioni i zgjedhjes së ngjyrës dhe nivelit të intensitetit. Ndonjëherë mund të lidheni me deri në 5 çelësa kontrolli shtesë EM26 ("slave") në EM 25.

TOUCH EM25 is microprocessor controlled electronic light dimmer. It serves as switch and dimmer for dimmable and some of non-dimmable lamps. Integrated microprocessor automatically identifies the type of lamp and adjusts the operating mode. It remembers the level of dimming after switching off due to integrated memory function. Soft-start function extends the lamp service life. An elegant LED indication is integrated into the button and the option of choosing a colour and intensity level is provided. Optionally one can connect of up to 5 additional control tasters EM26 (»slave«).

SWITCH / DIMMER UNIVERSAL RLC 0-300W 2M

- universal electronic dimmer for ON/OFF switching and dimming of all dimmable lamps (classical, halogen, LED, CFL, ...) and some non-dimmable lamps
- automatic detection of lamp type and adjustment of operating mode
- reduction of energy consumption
- soft start function extends life of lamps
- controlled by build-in micro switches
- memory function included – memorizes brightness on turn-off
- up to five (5) additional control units EM26 can be connected
- connection with 2-way switch is not possible
- build-in short-circuit, overheating and overload protection
- supply voltage 230V ~ 50Hz
- an elegant integrated LED indication with the option of setting colour and intensity.
- replacement of classical switch is possible at two-wire connection⁽¹⁾
- full functionality is achieved at three-wire connection⁽²⁾
- in accordance with EN 60669-1 and EN 60669-2-1
- screw contacts 1.5mm² (max. tightening torque 0.4Nm)

(1)lidhje me dy tela
two-wire connection

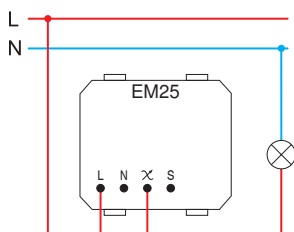

(2)lidhje me tre tela
three-wire connection

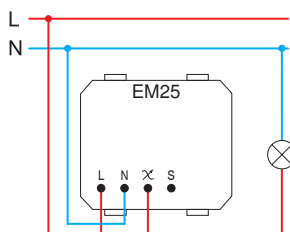

- lidhja me dy tela lejon uljen e ndriçimit të llambave me ulje ndriçimi
- two-wire connection allows dimming of dimmable lamps

- lidhja me tre tela lejon uljen e ndriçimit të llambave me ulje ndriçimi dhe disa pa ulje ndriçimi dhe llambave CFL
- three-wire connection allows dimming of dimmable lamps and some of non-dimmable LED and CFL lamps

	1	2	5	6	7
Min.	40 W	40 W	40 VA	40 VA	40 VA
Max.	300 W	300 W	300 VA	100 VA	100 VA
	(F)	(F)	(F)		

	1	2	4	6	7	8	9
Min.	0 W	0 W	0 VA	0 VA	0 VA	0 VA	0 VA
Max.	300 W	300 W	120 VA	120 VA	120 VA	120 VA	120 VA
	(F)	(F)	(F)			(F)	(F)

- 1 - llambë inkandeshente / incandescent lamp
- 2 - llambë halogjene / halogen lamp
- 4 - transformator elektrik me dimer / dimmable electronic transformer
- 5 - transformator klasik / classical transformer

- 6 - llambë CFL me ulje ndriçimi me kursim energjie / dimmable energy saving CFL lamp
- 7 - llambë LED me ulje ndriçimi / dimmable LED lamp
- 8 - llambë CFL pa ulje ndriçimi me kursim energjie / non-dimmable energy saving CFL lamp
- 9 - llambë LED pa ulje ndriçimi / non-dimmable LED lamp

shënime / remarks

- (F) filter EM27
- rekomandohet të përdoret filtri EM27 / it is recommended to use filter EM27
- të gjitha llambat e kontrolluara duhet të jenë të njëjta / all controlled lamps must be the same
- tabela e ngarkesave është e vlefshme për llambat me faktor fuqie PF>0.5 / table of loads is valid for lamps with power factor PF>0.5

ndezje/fikje dhe ulje e ndriçimit të llambës /
on / off swithcing and dimming of lamp

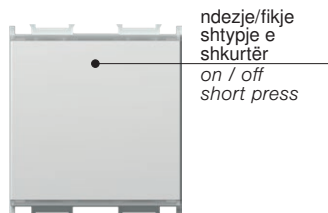

ndezje/fikje
shtypje e
shkurtër
on / off
short press

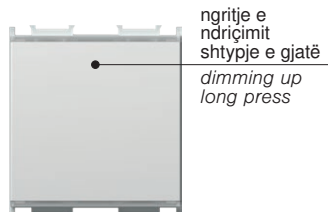

ngritje e
ndriçimit
shtypje e gjatë
dimming up
long press

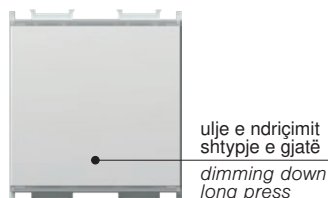

ulje e ndriçimit
shtypje e gjatë
dimming down
long press

Ngjyra e njësisë LED dhe zgjedhja e nivelit të intensitetit /
LED unit colour and intensity level selection

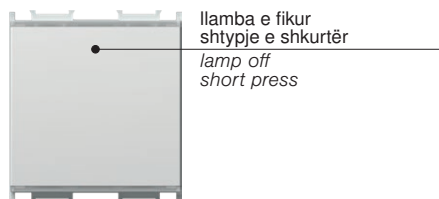

llamba e fikur
shtypje e shkurtër
lamp off
short press

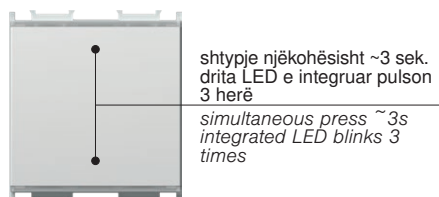

shtypje njëkohësisht ~3 sek.
drita LED e integruar pulson
3 herë
simultaneous press ~3s
integrated LED blinks 3
times



përzgjedhje e ngjyrave
shtypje e shkurtër
colour selection
short press

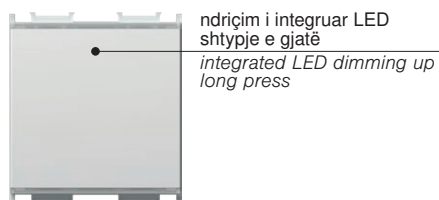

ndriçim i integruar LED
shtypje e gjatë
integrated LED dimming up
long press

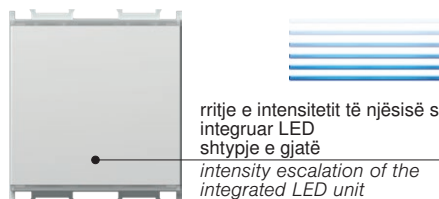

rritje e intensitetit të njësisë së
integruar LED
shtypje e gjatë
intensity escalation of the
integrated LED unit
long press

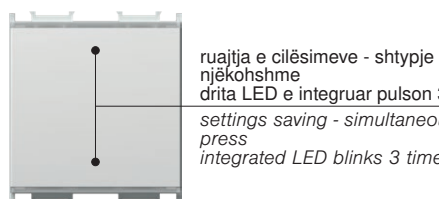

ruajtja e cilësimeve - shtypje e shkurtër e
njëkohshme
drita LED e integruar pulson 3 herë
settings saving - simultaneous short
press
integrated LED blinks 3 times

funksion "RESET"/
"RESET" function

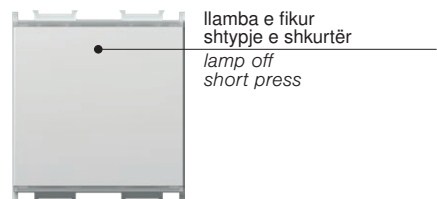

llamba e fikur
shtypje e shkurtër
lamp off
short press

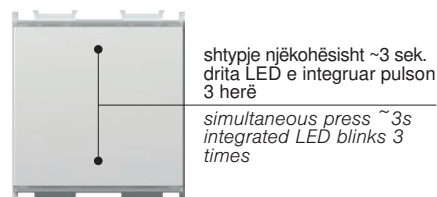

shtypje njëkohësisht ~3 sek.
drita LED e integruar pulson
3 herë
simultaneous press ~3s
integrated LED blinks 3
times

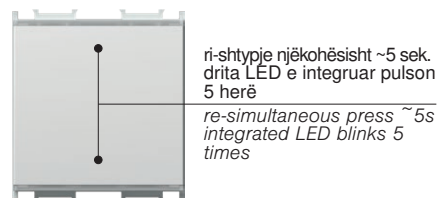

ri-shtypje njëkohësisht ~5 sek.
drita LED e integruar pulson
5 herë
re-simultaneous press ~5s
integrated LED blinks 5
times

* - rekomandohet në instalimin e reostatit
dhe ndërrimin e llambës

- e detyrueshme kur përdoren llamba pa ulje ndriçimi
- funksioni "RESET" nuk është i mundur kur përdoret lidhje me dy tela
- i mundur vetëm në EM25

- it is recommended at dimmer installation
and lamp replacement

- mandatory when using non-dimmable lamps
- "RESET" function is not possible when using two-wire connection
- only possible on EM25

masat paraprake të instalimit /
installation precautions

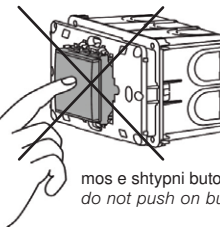
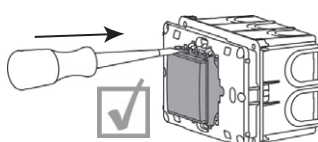
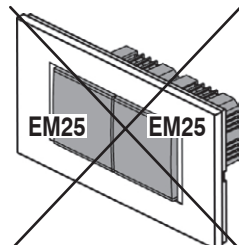
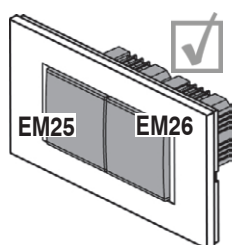

mos e shtypni butonin gjatë montimit /
do not push on button during mounting



- EM26PW
- EM26MW
- EM26SB
- EM26AT
- EM26ES
- EM26IW

NJËSI KONTROLLI ME BUTON ME SHTYPJE 2M

- e lidhur me reostatit universal EM25 lejon kontrollimin e llambave me të njëjtin funksionim (deri) si EM25
- tensioni i furnizimit, 230 V ~ 50 Hz
- në përputhje me standardet EN 60669-1 dhe EN 60669-2-1
- kontaktet e vidave 1,5 mm² (maks. e shtrengimit 0,4 Nm)

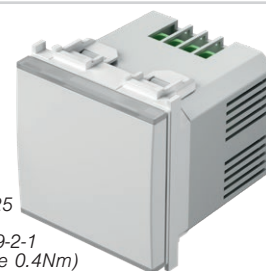

PUSH-BUTTON CONTROL UNIT 2M

- connected to universal dimmer EM25 allows controlling of lamps with same functionality as EM25
- supply voltage 230V ~ 50Hz
- in accordance with EN 60669-1 and EN 60669-2-1
- screw contacts 1.5mm² (max. tightening torque 0.4Nm)

(1) lidhje me dy tela
two-wire connection

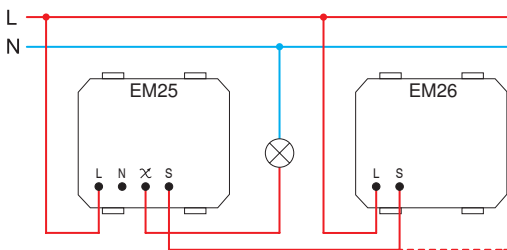

- lidhja me dy tela lejon uljen e ndriçimit të llambave me ulje ndriçimi
- në një lidhje me dy tela secila njësi shtesë kontrolli rrit ngarkesën minimale me 25 W
- two-wire connection allows dimming of dimmable lamps
- in a two-wire connection each additional control unit increases the minimum load by 25W

(2) lidhje me tre tela
three-wire connection

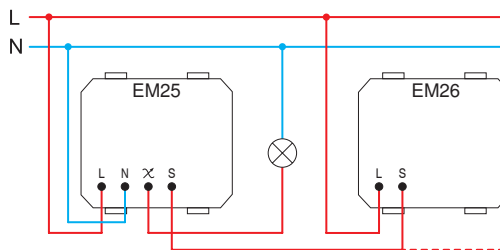

- lidhja me tre tela lejon uljen e ndriçimit të llambave me ulje ndriçimi dhe disa pa ulje ndriçimi dhe llambave CFL
- three-wire connection allows dimming of dimmable lamps and some of non-dimmable LED and CFL lamps



EM27

FILTRI I FREKUENCËS

- filtri i frekuencës për EM25
 - imazhi është simbolik
- FREQUENCY FILTER**
- frequency filter for EM25
 - image is symbolic

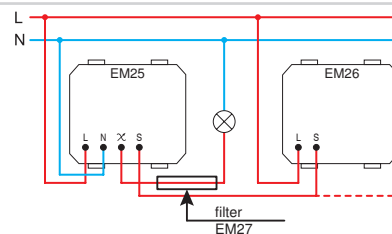

SET ÇELËS / REOSTAT UNIVERSAL RLC 0-300W 2M PP OL20

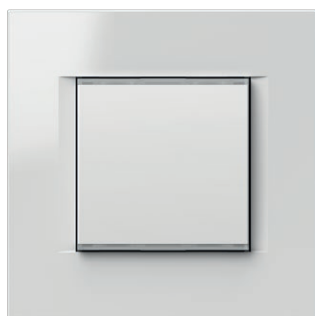

□ EM25PPOL20

- seti përfshin reostatit EM25, komizën e montimit 2M dhe kapakun mbulues LINE 2M PW
- për detaje teknike shikoni EM25

SET SWITCH / DIMMER UNIVERSAL RLC 0-300W 2M PP OL20

- set includes dimmer EM25, mounting frame 2M and cover plate LINE 2M PW
- for technical details see EM25



2M = 45 x 45

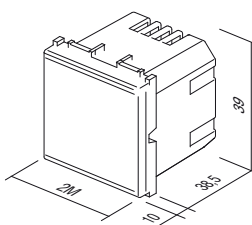

EM25
EM26

ÇELËS IR 5A 230V~ 1M



- EM31PW
- EM31MW
- EM31SB
- EM31AT
- EM31ES
- EM31IW

- çelës IR me infra të kuqe
- tensioni i furnizimit: 230 V~ ±10 % 50 Hz
- rele: 5 A / 250 V~ (zero kryqëzim)
- vlerësimi i mbrojtjes: IP40
- preja e tërthortë e telave në kontakt 0,75 - 2,5 mm²
- zona e zbulimit: deri në 110° në 20°C
- zona e zbulimit: rreth 8 m në 20°C
- rregullimi i kohëzgjatjes: nga rreth 5 sek. në 12 min.
- rregullimi i ndriçimit: nga rreth 5 deri 200 LUX
- temperatura e funksionimit: nga 0°C në +40°C
- i papërshtatshëm për instalim në kuti me thellësi 45 mm dhe kuti montimi në sipërfaqe CUBO IP20
- vetëm për përdorim të brendshëm



IR SWITCH 5A 230V~ 1M

- IR infrared switch
- supply voltage: 230V~ ±10 % 50Hz
- relay: 5A / 250V~ (zero crossing)
- protection rating: IP40
- cross-section of wires at the contact terminal: 0.75 - 2.5 mm²
- detection angle: up to 110° at 20°C
- detection area: approx. 8 m at 20°C
- adjustability of duration: from approx. 5 s to 12 min
- adjustability of brightness: from approx. 5 to 200 LUX
- operating temperature: from 0°C to +40°C
- not suitable for installation in 45 mm deep boxes and surface mount box CUBO IP20
- only for indoor usage

ÇELËS IR 5 A 230 V~ 2M

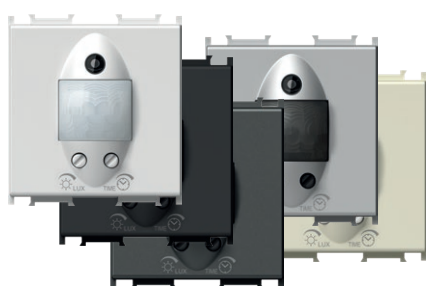

- EM32PW
- EM32MW
- EM32SB
- EM32AT
- EM32ES
- EM32IW

- çelës IR me infra të kuqe
- tensioni i furnizimit: 230 V~ ±10 % 50 Hz
- rele: 5 A / 250 V~ (zero kryqëzim)
- vlerësimi i mbrojtjes: IP40
- preja e tërthortë e telave në kontakt 0,75 - 2,5 mm²
- zona e zbulimit: deri në 110° në 20°C
- zona e zbulimit: rreth 8 m në 20°C
- rregullimi i kohëzgjatjes: nga rreth 5 sek. në 12 min
- rregullimi i ndriçimit: nga rreth 5 deri 200 LUX
- temperatura e funksionimit: nga 0°C në +40°C
- i papërshtatshëm për instalim në kuti me thellësi 45 mm dhe kuti montimi në sipërfaqe CUBO IP20
- vetëm për përdorim të brendshëm



IR SWITCH 5A 230V~ 2M

- IR infrared switch
- supply voltage: 230V~ ±10 % 50Hz
- relay: 5A / 250V~ (zero crossing)
- protection rating: IP40
- cross-section of wires at the contact terminal: 0.75 - 2.5 mm²
- detection angle: up to 110° at 20°C
- detection area: approx. 8 m at 20°C
- adjustability of duration: from approx. 5 s to 12 min
- adjustability of brightness: from approx. 5 to 200 LUX
- operating temperature: from 0°C to +40°C
- not suitable for installation in 45 mm deep boxes and surface mount box CUBO IP20
- only for indoor usage

gama e zbulimit /
detection range

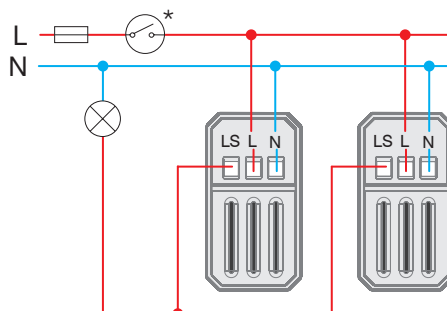
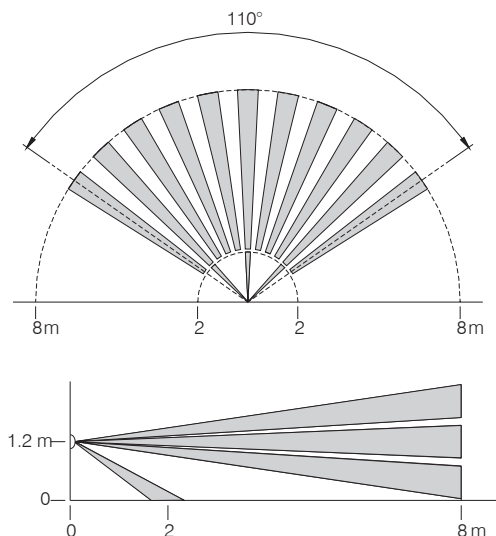

E L E C T R O N I C S E M

koha dhe rregullimi për muzgun /
time and twilight adjustment

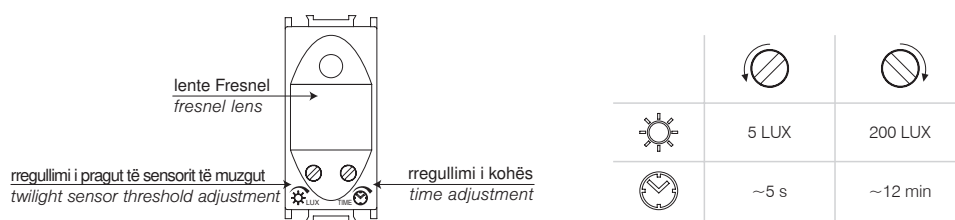

	1	2	3	4	5	6	7	8
Min.	1 W	1 W		1 VA	1 W	1 W	1 VA	1 VA
Max.	800 W	800 W	5A	6x20 VA	6x36 W	4x36 W (20μF)	6x23 VA	6x20 VA

1 - llambë inkandeshente /
incandescent lamp

2 - llambë halogjene /
halogen lamp

3 - element ngrohjeje me rezistencë /
resistive heating element

4 - transformator elektrik /
electronic transformer

5 - llambë neoni fluoreshente (versioni 1) /
fluorescent tube (version 1)

6 - llambë neoni fluoreshente (versioni 2) /
fluorescent tube (version 2)

7 - llambë CLF me kursim energjie /
energy saving CFL lamp

8 - llambë LED /
LED lamp

kujdes /
attention

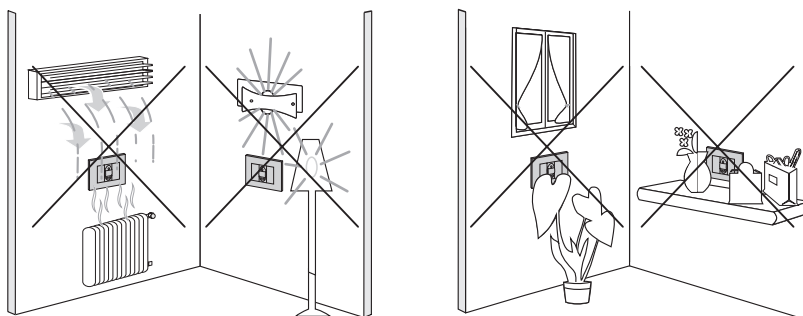

1M = 22,5 x 45
2M = 45 x 45

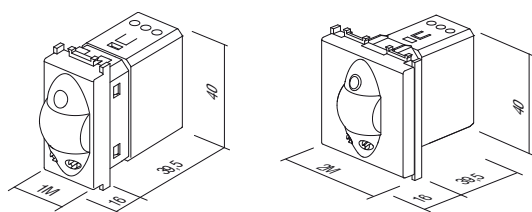

TERMOSTAT BAZË 6 A 230 V ~ 2M



- EM37PW
- EM37SB
- EM37AT
- EM37ES
- EM37IW

- termostat elektronik, bazë
- regjimi i funksionimit: ngrohje/ftohje/fikje
- tensioni i furnizimit: 230 V AC, 50 Hz
- dalja: 6(2) A, 230 V AC, çelësi i relesë
- gama e rregullimit: +10 °C deri +30 °C
- histereza: ±0,5 °C, ED = 20 min
- mbrojtja kundër ngrirjes (regjimi i ngrohjes): +6 °C
- mbrojtja nga mbinxehja (regjimi i ftohjes): +32 °C
- funksioni ECO për uljen e temperaturës me 3 °C për 6 orë në regjimin e ngrohjes dhe rritjen e temperaturës me 3 °C për 6 orë në regjimin e ftohjes
- funksioni përshtatës ECO, automatikisht çdo ditë në të njëjtën orë ul temperaturën me 3 °C për 6 orë në regjimin e ngrohjes dhe e rrit temperaturën me 3 °C për 6 orë në regjimin e ftohjes
- opsioni për të aktivizuar regjimin e funksionimit ECO me aktivizim të jashtëm përmes një hyrjeje të veçantë
- Sinjalizimi LED i funksionimit
- i papërshatshëm për ngrohje elektrike nga dyshemeja
- kontaktet e vidave maks. 2,5 mm²
- në përputhje me Direktivën LV, Direktivën EMC, standardet EN60730-1 dhe EN60730-2-9
- për funksionim të saktë, rekomandojmë instalimin e një kutie të pavarur, të ndarë nga pajisjet që gjenerojnë nxehtësi
- temperatura e funksionimit: 5 ÷ 35 °C
- temperatura e magazinimit: -20 ÷ 50 °C



Termostatit është i destinuar për rregullimin e temperaturës në dhomë. Termostatit mundëson dy regjime funksionimi - ngrohje ose ftohje. Ai ka funksione sigurie të instaluar për mbrojtje kundër ngrirjes (regjimi i ngrohjes) dhe mbrojtje kundër mbinxehjes (regjimi i ftohjes). Funksionimi tregohet nëpërmjet sinjalizimit LED. Konfigurimi i termostatit kryhet me ndihmën e një butoni rrotullues për caktimin e temperaturës dhe me butona të tjerë me prekje kapacitive.

The thermostat is intended for regulating temperature in a room. A thermostat enables two modes of operation – heating or cooling. It has safety functions installed for protection against freezing (heating mode) and protection against overheating (cooling mode). The operation is indicated via LED signaling. Thermostat setup is performed with the help of a rotary button for setting the temperature and with other capacitive touch buttons.

THERMOSTAT BASIC 6A 230 V ~ 2M

- electronic thermostat, basic
- operation mode: heating/cooling/turn off
- power supply: 230 VAC, 50 Hz
- output: 6(2) A, 230 VAC, relay switch
- regulation range: +10 °C to +30 °C
- hysteresis: ±0.5 °C, ED = 20min
- anti-freeze protection (heating mode): +6 °C
- overheating protection (cooling mode): +32 °C
- ECO function for lowering the temperature by 3 °C for 6 hours in the heating mode and raising temperature by 3 °C for 6 hours in the cooling mode
- adaptive ECO function, automatically every day at the same time lowers the temperature by 3 °C for 6 hours in the heating mode and raises temperature by 3 °C for 6 hours in the cooling mode
- option to turn on the ECO operating mode by external trigger via a separate input
- LED signalling of the operation
- not suitable for electrical floor heating
- screw contacts max. 2.5 mm²
- in accordance with the LV Directive, the EMC Directive, standards EN60730-1 and EN60730-2-9
- for correct operation, we recommend installing in an independent single box, separate from devices that generate heat
- operating temperature: 5 ÷ 35 °C
- storage temperature: -20 ÷ 50 °C

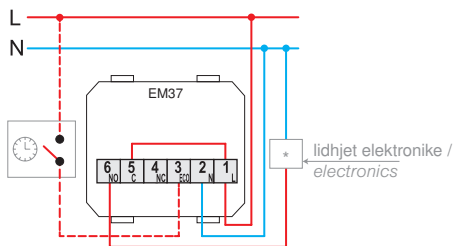

pompa e qarkullimit, vatra (lidhja direkte),
transmision termoelektrik /
circulation pump, burner (direct connection)
thermoelectric drive

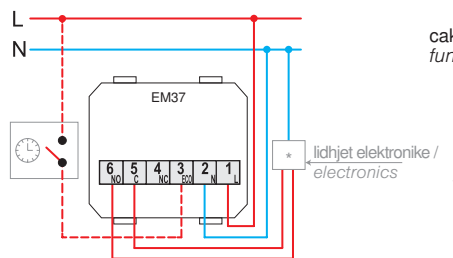

bojleri, pompa e nxehtësisë, vatra (hyrja e kontrollit T1/T2) /
boiler, heat pump, burner (control input T1/T2)

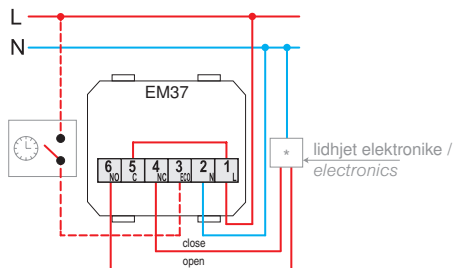

transmisioni me motor (përdorim i kufizuar me ngrohje nën dysheme) /
motor drive (limited use with underfloor heating)

caktimi i funksionit në temperaturë /
function and temperature adjustment

butoni i përzgjedhjes së funksioneve dhe treguesit i statusit të LED-it:
e kuqe: ngrohje
blu: kondicioner
pa ndriçim: e fikur

function selection button and LED status signalization:
red: heating
blue: air conditioning
no light: switched off

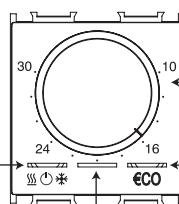

caktimi i funksionit të temperaturës
temperature setting

butoni i përzgjedhjes së funksioneve "ECO" dhe treguesit të statusit "ECO" të LED-it e gjelbër: kursimi i energjisë ECO aktiv portokalli: regjimi ECO adaptiv i aktivizuar pa ndriçim: regjimi i ditës

"ECO" function selection button and LED "ECO" status indicator
green: ECO energy saving ON
orange: adaptive ECO mode activated
no light: day mode

treguesi LED i gjendjes së relesë së daljes e bardhë: releja e ndezur pa ndriçim: releja e fikur

LED output relay state signalization
white: relay ON
no light: relay OFF

kujdes /
attention

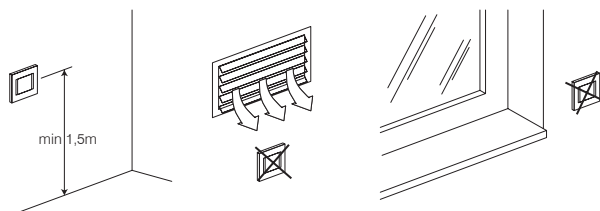



- EM38PW
- EM38MW
- EM38SB
- EM38AT
- EM38ES
- EM38IW

TERMOSTATI I NGROHJES 5(2)A 230V~ 2M

- mënyra e funksionimit: ftohje
- furnizimi me energji elektrike: 230 V AC, 50 Hz
- impulsi i tensionit: 4 kV
- konsumi i energjisë: < 0,5 W
- prodhimi: 2 A (maksimumi 5 A); 230 V AC, 50 Hz
- dalja e ndërrimit: NO (maksimumi 10 aktivizues)
- gama e rregullimit: +5°C deri +30°C
- mbrojtja nga ngricat: +5°C
- histereza: 0,5 K
- mbrojtja: IP30
- lloji i sensorit: Bimetal
- lloji i lidhjes elektrike: kontakte me susta
- lloji i përcjellësve: 0,75 - 1,5 mm² (bërthama fleksibël me fije); 1,0 - 2,5 mm² (bërthama e fortë)
- në përputhje me direktivën DIN EN 60730



HEATING THERMOSTAT 5(2)A 230V~ 2M

- operation mode: heating
- power supply: 230 VAC, 50 Hz
- voltage pulse: 4 kV
- energy consumption: < 0.5 W
- output: 2 A (max. 5 A); 230 VAC, 50 Hz
- switching output: NO (max. 10 actuators)
- regulation range: +5°C to +30°C
- frost protection: +5°C
- hysteresis: 0.5 K
- protection: IP30
- sensor type: Bimetal
- type of electrical connection: Spring-loaded contacts
- type of conductors: 0.75 - 1.5 mm² (flexible-stranded core); 1.0 - 2.5 mm² (solid core)
- in compliance with Directive DIN EN 60730

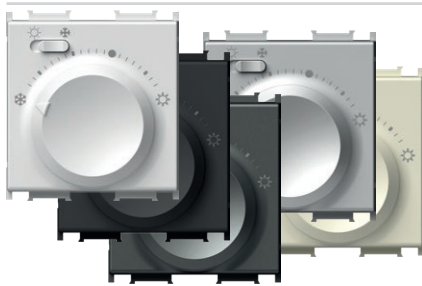

- EM39PW
- EM39MW
- EM39SB
- EM39AT
- EM39ES
- EM39IW

TERMOSTAT NGROHJEJE/FTOHJEJE 3(1,5)A 230V~ 2M

- mënyra e funksionimit: ftohje/ngrohje
- furnizimi me energji elektrike: 230 V AC, 50 Hz
- impulsi i tensionit: 4 kV
- konsumi i energjisë: < 0,5 W
- prodhimi: 1.5 A (maksimumi 3 A); 230 V AC, 50 Hz
- dalja e ndërrimit: çelësi i zgjedhjes së modalitetit (maksimumi 5 aktivizues)
- gama e rregullimit: +5°C deri +30°C
- mbrojtja nga ngricat: +5°C
- histereza: 0,5 K
- mbrojtja: IP30
- lloji i sensorit: Bimetal
- lloji i lidhjes elektrike: kontakte me susta
- lloji i përcjellësve: 0,75 - 1,5 mm² (bërthama fleksibël me fije); 1,0 - 2,5 mm² (bërthama e fortë)
- në përputhje me direktivën DIN EN 60730



HEATING/COOLING THERMOSTAT 3(1.5)A 230V~ 2M

- operation mode: cooling/heating
- power supply: 230 VAC, 50 Hz
- voltage pulse: 4 kV
- energy consumption: < 0.5 W
- output: 1 A (max. 3 A); 230 VAC, 50 Hz
- switching output: mode selector switch (max. 5 actuators)
- regulation range: +5°C to +30°C
- frost protection: +5°C
- hysteresis: 0.5 K
- protection: IP30
- sensor type: Bimetal
- type of electrical connection: Spring-loaded contacts
- type of conductors: 0.75 - 1.5mm² (flexible-stranded core); 1.0 - 2.5 mm² (solid core)
- in compliance with the Directive DIN EN 60730

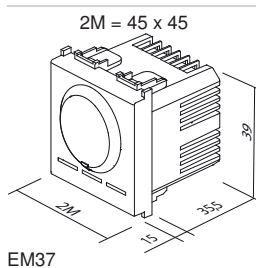
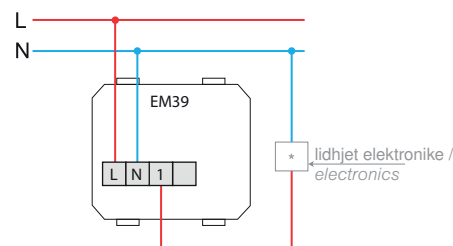
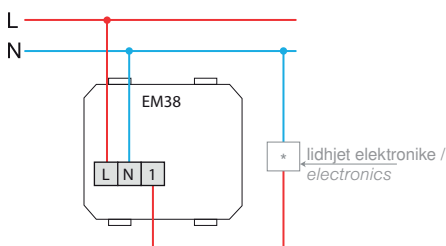

EM37

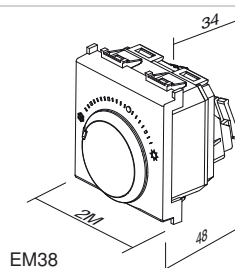

EM38

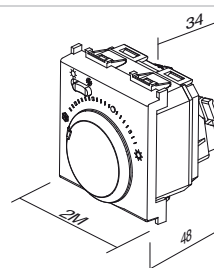

EM39



NM39

KORNIZË MONTIMI ME VIDA PËR TERMOSTATE FANTINI COSMI 3M

- kornizë montimi me vida për termostate Fantini Cosmi 3M
- i përshtatshëm për përdorim me modelet e përditshme të termostateve Fantini Cosmi CH121 dhe CH123
- i përshtatshëm për përdorim me modelet javore të termostateve Fantini Cosmi CH141A dhe CH143A
- për montim në kutitë drejtkëndore 3M
- i përshtatshëm për montimin me kapakët mbulues PURE, Line, Soft



MOUNTING FRAME WITH SCREWS FOR FANTINI COSMI THERMOSTATS 3M

- mounting frame with screws for Fantini Cosmi thermostats 3M
- suitable for use with Fantini Cosmi daily thermostats models CH121 and CH123
- suitable for use with Fantini Cosmi weekly thermostats models CH141A and CH143A
- for mounting in rectangular boxes 3M
- suitable for assembling with cover plates PURE, Line, Soft



- EM40PW
- EM40MW
- EM40SB
- EM40AT
- EM40ES
- EM40IW

ÇELËSI I KARTËS SË KURSIMIT TË ENERGJISË 3 A 250 V~ 3M

- çelës karte bazë, çdo kartë ISO
- tensioni i furnizimit, 230 V ~ 50 Hz
- dalja 3 A 250 V~ për kontaktorin e çelësit *
- vonesa e fikjes 15-20 sek.
- në përputhje me EN 61000-6-1
- karta nuk është e përfshirë
- jo për kontrollin e aksesit



ENERGY SAVER CARD SWITCH 3A 250V~ 3M

- card switch basic, any ISO card
- supply voltage 230V~ 50Hz
- output 3A 250V~ for switching contactor *
- switch off delay 15-20s
- in accordance with EN 61000-6-1
- card is not included
- not for access control

3M = 67,5 x 45

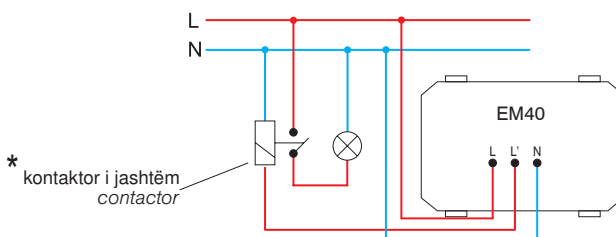
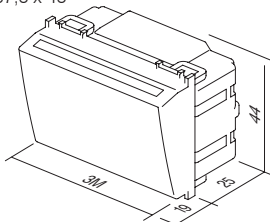

KARTË ISO

EM47

- kartë ISO
- për kombinim me çelës karte EM40
- madhësia: 85x54 mm

CARD ISO

- ISO card
- for combination with card switch EM40
- size: 85x54 mm

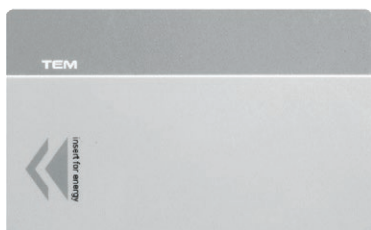



EM44BK

ÇELËS KARTE PËR KURSIM TË ENERJISË RF HF 13,56 MHz 3M

- çelës kartë elektronike për kartë RFID ISO
- furnizimi nga njësia e rele së EM49 përmes konektorëve të kabllove RJ12
- dalja të lidhet me njësinë e daljes së rele së EM49
- vonesë 15-20 sek. e çelësit "kryesor të energjisë" me heqjen e kartës
- vonesë 1 min. e çelësit "HVAC" me heqjen e kartës kur hapen dyert ose dritaret e ballkonit
- në përputhje me EN 61000-6-1
- karta nuk është e përfshirë
- jo për kontrollin e aksesit

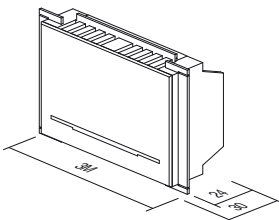
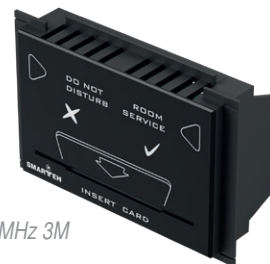

ENERGY SAVER CARD SWITCH RF HF 13,56MHz 3M

- electronic card switch for RFID ISO card
- supply from relay unit EM49 through cable connectors RJ12
- output to be connected to relay output unit EM49
- 15-20s "main power" switch off delay with card withdrawal
- 1 min "HVAC" switch off delay with card withdrawal when balcony doors or windows opened
- in accordance with EN 61000-6-1
- card is not included
- not for access control

NJËSIA E KONTROLLIT TË KURSIMIT TË ENERJISË 2x16 A 250 V~

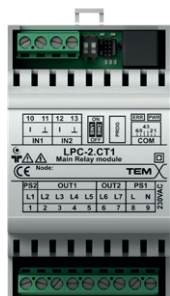

EM49

- njësi releje për çelësat e kartës EM44
- tensioni i furnizimit, 230 V ~ 50 Hz
- në përputhje me EN 61000-6-1
- montim në shinë DIN 35 mm, 3MU
- hyrje dhe dalje në varësi të implementimit: dhomë njëshe ose dyshe

ENERGY SAVER CONTROL UNIT 2x16A 250V~

- relay unit for card switches EM44
- supply voltage 230V~ 50Hz
- in accordance with EN 61000-6-1
- mounting on DIN rail 35mm, 3MU
- input and output depending on implementation: single or double room

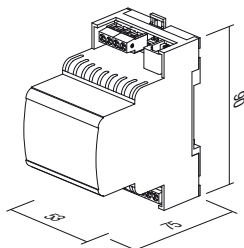

SHPËRNDARËS SPL-1



EM45

- përdoret për të lidhur dy module periferike EM44 me njësinë e rele së EM49
- konektori i komunikimit RJ12
- madhësia: 37 x 30 x 27 mm

SPLITTER SPL-1

- used to connect two peripheral modules EM44 to relay unit EM49
- communication connector RJ12
- size: 37 x 30 x 27 mm

skema e instalimeve elektrike për implementim në dhomë njëshe / wiring diagram for single room implementation

skema e instalimeve elektrike për implementim në dhomë dyshe / wiring diagram for double room implementation

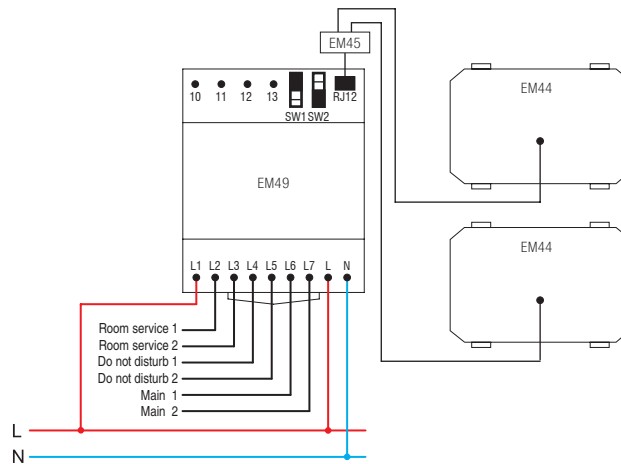
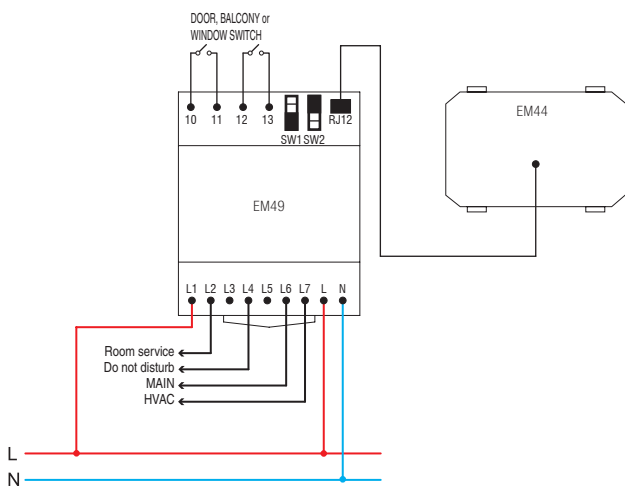

kabloja e lidhjes RJ12 mes EM44 dhe EM49 / connection cable RJ12 between EM44 and EM49

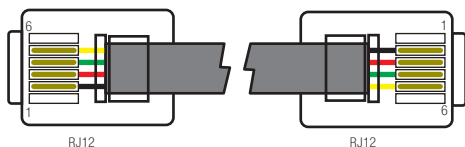

PRIZË PËR RROJË 230 V~/120 V~ 3M

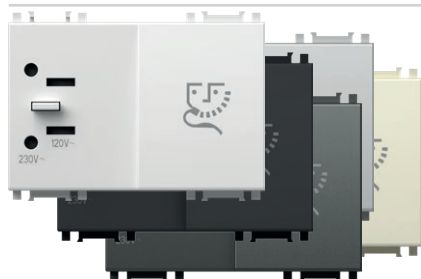

- EM60PW
- EM60MW
- EM60SB
- EM60AT
- EM60ES
- EM60IW

- njësi furnizimi për rojë me transformator izolues 20 VA
- furnizimi: 230 V~ 50-60 Hz
- dalja:
- 230 V~ për 2P 2,5 A spinë Euro ose
- 120V~ për 2P 15 A spinë amerikane
- Klasi II
- në përputhje me EN 61558-2-5



SOCKET SHAVER 230V~/120V~ 3M

- shaver supply unit with isolating transformer 20VA
- supply: 230V~ 50-60Hz
- output:
- 230V~ for 2P 2.5A Europlug or
- 120V~ for 2P 15A American plug
- Class II
- in accordance with EN 61558-2-5

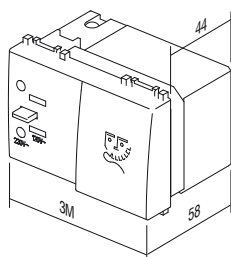

3M = 67,5 x 45

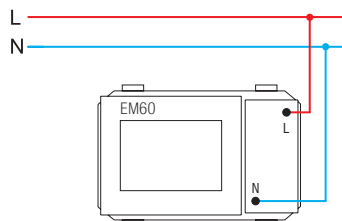

NJËSIA E FURNIZIMIT ME ENERGJI USB 5 V 2,1 A 1M



- EM67PW
- EM67MW
- EM67SB
- EM67AT
- EM67ES
- EM67IW

- për karikimin e pajisjeve elektronike përmes një porte standarde USB (e përputhshme gjithashtu edhe me pajisjet Apple)
- furnizimi me energji: 100-230 V~ 50/60 Hz
- konsumi i energjisë:
- 300 mA në 100 V~/150 mA në 230 V~
- konsumi i energjisë në gatishmëri: 30mW në 230 V~
- tensioni nominal në dalje: 5 VDC (±5 %) SELV
- tensioni i ondulacionit në dalje: 150 mV
- rryma nominale në dalje: 2,1 A (1 x 2100 mA) (±10 %)
- efikasiteti: maksimumi 77%
- temperatura e funksionimit: 0°C/+45°C (përdorimi i brendshëm)
- Klasi mbrojtës IP: IP20, vetëm për përdorim në ambiente të brendshme
- klasi i pajisjes II
- kategoria e mbritensionit (EN 62109): klasi III
- kontaktet e vidave: maks. 2,5 mm²
- pajisje me hapësirë kontakti prej të paktën 3 mm
- në përputhje me standardet EN 60950-1 dhe Direktivës LVC dhe EMC

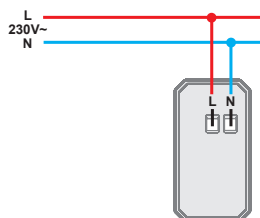
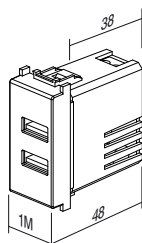

USB POWER SUPPLY UNIT 5V 2,4A 1M

- for charging of electronic devices via a standard USB port (also compatible with Apple devices)
- power supply: 100-230V~ 50/60Hz
- power consumption: 300mA at 100V~/150mA at 230V~
- standby power consumption: 30mW at 230V~
- nominal output voltage: 5 VCD (± 5%) SELV
- output ripple voltage: 150mV
- nominal output current: 2,4A (±10%)
- efficiency: maximum of 77%
- operating temperature: 0°C/+45°C (indoor use)
- IP protection class: IP20, indoor use only
- class device II
- overvoltage category (EN 62109): Class III
- screw contacts: max. 2.5 mm²
- device with a contact gap of at least 3mm
- in accordance with EN 60950-1 and LVD & EMC directives
- not suitable for installation in 45 mm deep boxes and surface mount boxes CUBO IP20

NJËSIA E FURNIZIMIT ME ENERGJI USB 5 V 3,0 A



- EM68PW
- EM68MW
- EM68SB
- EM68AT
- EM68ES
- EM68IW

- për karikimin e pajisjeve elektronike përmes një porte standarde USB (e përputhshme gjithashtu edhe me pajisjet Apple)
- furnizimi me energji: 100-230 V~ 50/60 Hz
- konsumi i energjisë: 300 mA në 100 V~/150 mA në 230 V~
- konsumi i energjisë në gatishmëri: 30mW në 230 V~
- tensioni nominal në dalje: 5 VCD ($\pm 5\%$) SELV
- tensioni i ondulacionit në dalje: 150 mV
- rryma nominale në dalje: 3,0 A ($\pm 10\%$)
- lloji i konektorit: USB A / USB C
- efikasiteti: maksimumi 77%
- temperatura e funksionimit: 0°C/+45°C (përdorimi i brendshëm)
- klasi i mbrojtjes IP: IP20, vetëm për përdorim në ambiente të brendshme
- klasi i pajisjes II
- kategoria e mbtensionit (EN 62109): Klasi III
- kontaktet e vidave maks. 2,5 mm²
- pajisje me hapësirë kontakti prej të paktën 3 mm
- në përputhje me standardet EN 60950-1 dhe Direktivës LVC dhe EMC

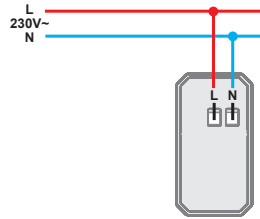
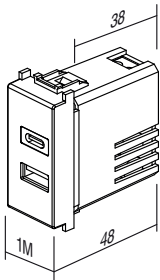

USB POWER SUPPLY UNIT 5V 3,0A

- for charging of electronic devices via a standard USB port (also compatible with Apple devices)
- power supply: 100-230V~ 50/60Hz
- power consumption: 300mA at 100V~/150mA at 230V~
- standby power consumption: 30mW at 230V~
- nominal output voltage: 5 VCD ($\pm 5\%$) SELV
- output ripple voltage: 150mV
- nominal output current: 3,0 A ($\pm 10\%$)
- connector type: USB A / USB C
- efficiency: maximum of 77%
- operating temperature: 0°C/+45°C (indoor use)
- IP protection class: IP20, indoor use only
- class device II
- overvoltage category (EN 62109): Class III
- screw contacts: max. 2.5 mm²
- device with a contact gap of at least 3mm
- in accordance with EN 60950-1 and LVD & EMC directives
- not suitable for installation in 45 mm deep boxes and surface mount boxes CUBO IP20

DRITË EMERGJENCE LED 250 V~ 0,90 W, NiCd 3h 7M



- EM55

- dritë emergjence LED
- tensioni i furnizimit 250 V~ 50 Hz 3x LED 0,3 W, 10000 mcd, 6500K
- akumulator NiCd 4,8V 400 mAh, i ndërrueshëm
- autonomia 3 orë, karikimi 24h
- Klasi II
- në përputhje me standardet EN 60598-1, EN 60598-2-2, EN 60598-2-22



LED EMERGENCY LIGHT 250V~ 0.90W, NiCd 3h 7M

- emergency LED lamp
- supply voltage 250V~ 50Hz 3x LED 0,3W, 10000mcd, 6500K
- NiCd accumulator 4,8V 400 mAh, replaceable
- autonomy 3h, charging 24h
- Class II
- in accordance with EN 60598-1, EN 60598-2-2, EN 60598-2-22

7M = 157 X 45

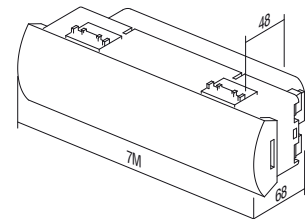
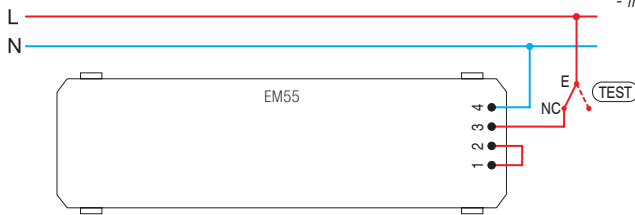

DRITË EMERGJENCE LED 230 V~50 Hz, 0,5 W, NiMH 2 ORË 2M



- EM57

- llambë emergjence LED
- opion për ta përdorur si llambë koke (mekanizmi me tërheqje)
- tensioni i furnizimit 230 V~50 Hz, 1xLED 0,5 W
- Akumulator NiMH 3,6V 140 mAh, i zëvendësueshëm
- autonomia 2 orë, karikimi 36 orë
- klasi i pajisjes II
- në përputhje me standardet EN60598-1, EN60598-2-2, EN62471, EN55015:2006, EN61547

LED EMERGENCY LIGHT 230V~50Hz, 0.5W, NiMH 2h 2M

- emergency LED lamp
- option to use it as a hand lamp (pull-out mechanism)
- supply voltage 230V~50Hz, 1xLED 0.5W
- NiMH accumulator 140mAh, replaceable
- autonomy 2h, charging 36h
- class device II
- in accordance EN60598-1, EN60598-2-2, EN62471, EN55015:2006, EN61547

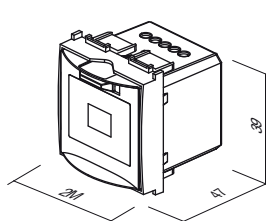
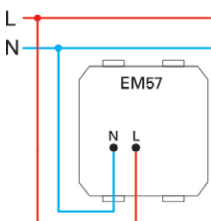
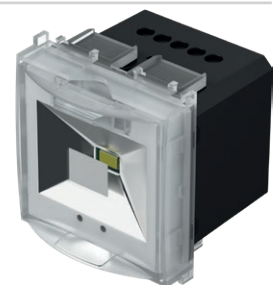

NJËSI LED NJËNGJYRËSHE AMBIENT

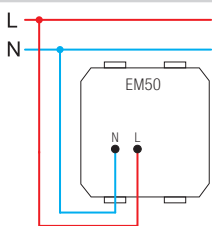
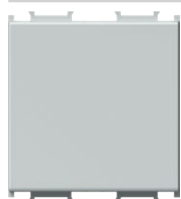

- EM50WH
- EM50BL
- EM50RD
- EM50GR

- llambë LED shënuese
- tensioni i furnizimit, 230 V ~ 50 Hz, 0,8 W, 6500K
- Klasi II
- në përputhje me EN 60598-1
- përdorim opsional për ndriçimin e drejtimt ose sinjalit me printim të personalizuar me lazer në difuzor

*LED AMBIENT UNIT MONOCOLOUR
250V~ 0,8W 2M*

- step marker LED unit
- supply voltage 230V~ 50Hz 0,8W, 6500K
- Class II
- in accordance with EN 60598-1
- optional usage for directional signalization with customized laser printing on diffuser



LLAMBË LED ME DY NGJYRA 250 V~ 2 x 0,4 W 2M

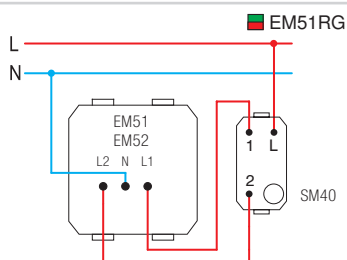

- EM51RG

- llambë LED sinjalizuese me dy ngjyra (e kuqe/e gjelbër)
- tensioni i furnizimit, 230 V ~ 50 Hz, 0,8 W, 6500K
- Klasi II
- në përputhje me EN 60598-1
- difuzori përfshin grafikët siç tregohet
- mundësi për printim të personalizuar me lazer në difuzor

LED LAMP DUAL COLOR 250V~ 2x0,4W 2M

- signaling dual color (red/green) LED lamp
- supply voltage 230V~ 50Hz 2x0,4W, 6500K
- Class II
- in accordance with EN 60598-1
- diffuser includes graphics as shown
- possible customized laser printing on diffuser



LLAMBË LED 3D ME DY NGJYRA 250 V~ 2 x 0,4 W 2M

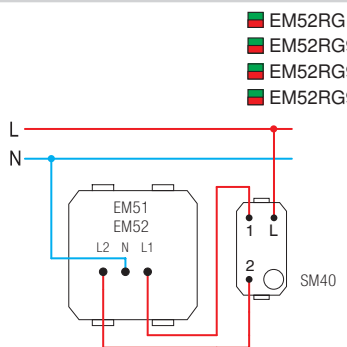

- EM52RG
- EM52RG90
- EM52RG91
- EM52RG99

- llambë LED sinjalizuese me dy ngjyra (e kuqe/e gjelbër) me simbol 3D
- tensioni i furnizimit, 230 V ~ 50 Hz, 0,8 W, 6500K
- Klasi II
- në përputhje me EN 60598-1
- mundësi për grafikë të personalizuar sipas kërkesës
- 90 simbol mashkull, 91 simbol femër, 99 simbol sipas kërkesës

*LED LAMP 3D DUAL
COLOR 250V~ 2x0,4W 2M*

- signalling LED lamp, dual color (red/green) with 3D symbol
- supply voltage 230V~ 50Hz 2x0,4W, 6500K
- class II
- in accordance with EN 60598-1
- possible customized graphics on request
- 90 male symbol, 91 female symbol, 99 symbol on request

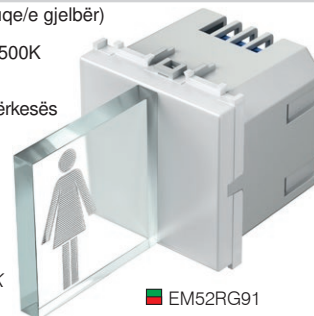

■ EM52RG91

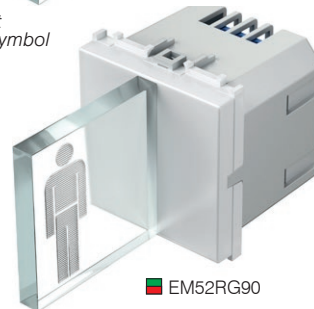

■ EM52RG90

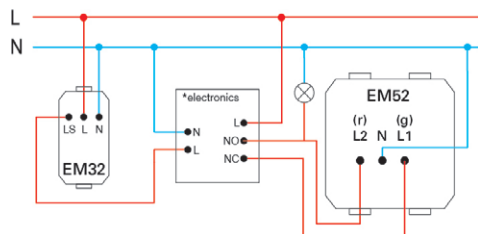

2M = 45 x 45

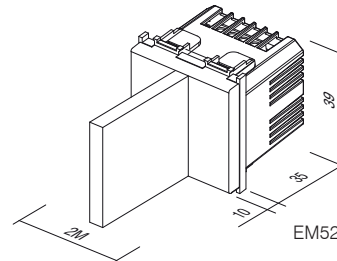
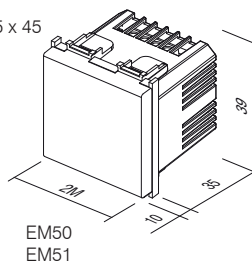

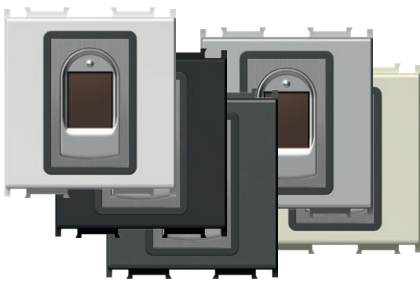

- EM71PW
- EM71MW
- EM71SB
- EM71AT
- EM71ES
- EM71IW

ÇELËS ME GJURMË GISHTI BIOPASS 2M

- çelës me gjurmë gishti me njësi releje të brendshme dhe furnizim me energji
- Kapaciteti: 500 gjurmë gishtash
- Menaxhim i lehtë përmes aplikacionit për celular X-Manager
- Tensioni i furnizimit me energji: 8-30 V – DC ose AC (përfshihet furnizimi me energji)
- Sensor me prekje kapacitative
- Rele me 2 dalje
- Tensioni/rryma maksimale në rele: 40 V/3 A
- Koha e aktivizimit të rele së: 1-10 sek.
- Fuqia maksimale: 3,6 W
- lidhje e enkriptuar 256-bit mes çelësit dhe njësisë së rele së brendshme
- Seti përfshin gjithashtu kornizën e montimit NM24 dhe pllakën e kapakut dekorativ OS20.

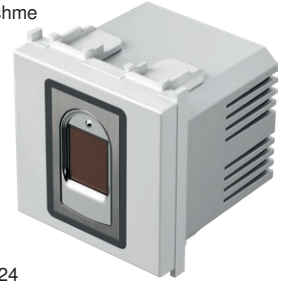

FINGERPRINT SWITCH BIOPASS 2M

- fingerprint switch with included internal relay unit and power supply
- capacity: 500 fingerprints
- easy management via X-Manager mobile app
- power supply voltage: 8-30V – DC or AC (power supply included)
- capacitive sensor
- 2 output relays
- maximum voltage/current on relay: 40V/3A
- relay triggering time: 1-10 sec
- maximum power: 3.6W
- 256-bit encrypted link between switch and internal relay unit
- Set also includes NM24 mounting frame and OS20 decorative cover plate.

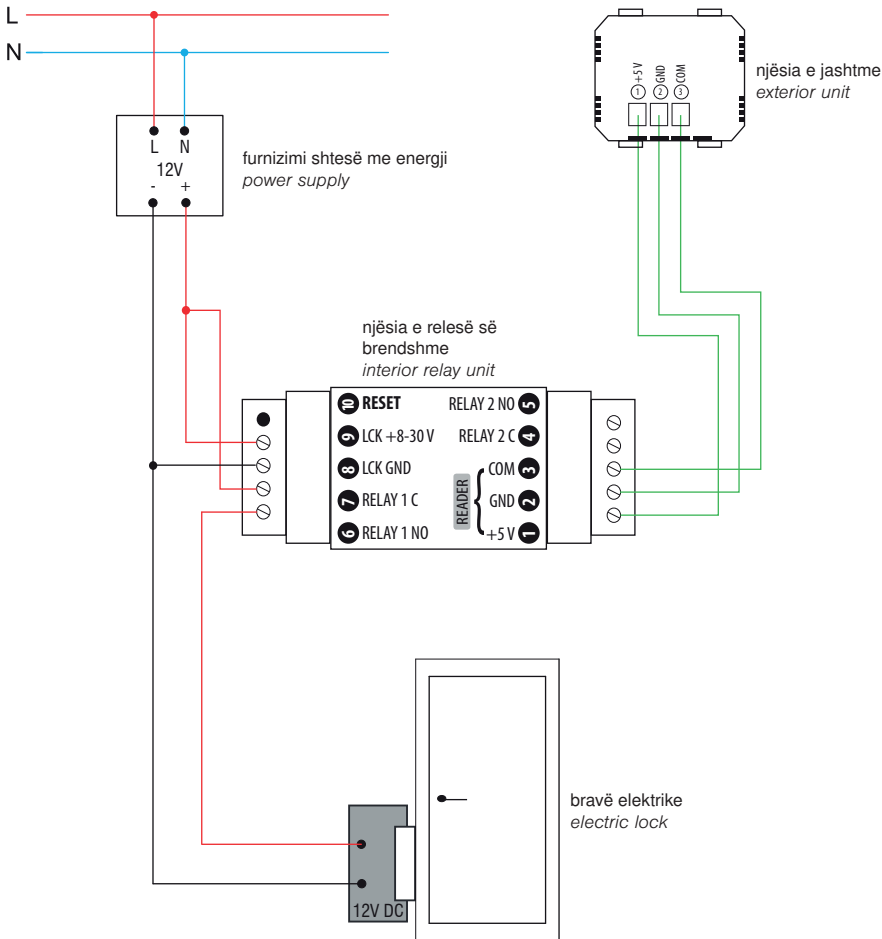

X-Manager app

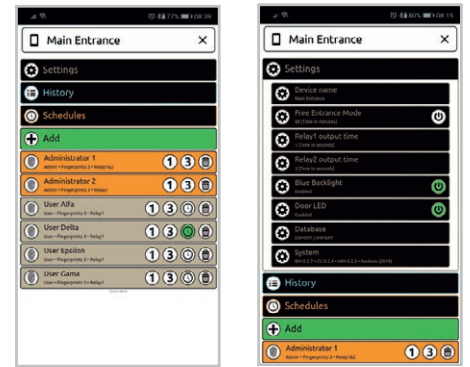

support.tem.si



njësia e jashtme exterior unit

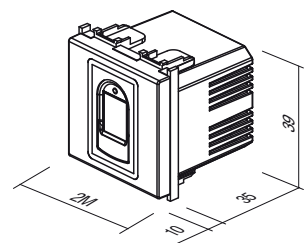

KOHËMATËS ME SHUMË FUNKSIONE EM82



- EM82PW
- EM82MW
- EM82SB
- EM82AT
- EM82ES
- EM82IW

- Tensioni i furnizimit: 230 VAC, 50Hz
- Dalja: Rele 16 A/250 VAC, 50 Hz
- Seksioni kryq i tellit: 0,75 – 4.0 mm²
- Temperatura e funksionimit: 0°C deri +40°C
- Temperatura e ruajtjes: -5°C deri +60°C
- Funksionet: **kohëmatës, releja (çelësi i kontrolluar), çelësi, butoni me shtypje**
- Treguesi i programit/statusit: RGB LED
- Numri i butonave: 2
- Tipi i funksionimit të butonit me shtypje: Me prekje kapacitive
- Numri i portave: 6 - 2x N, 2x L, 1x hyrje e kontrolluar (S)
- Opsioni i hyrjes së kontrolluar: Po. Lidhja e sinjalit kryesor të tensionit (230 VAC) me terminalin S.
- U zbatua funksioni “zero kalim” (takim-stakimi i çelësit kur tensioni kalon përmes 0 V)
- Konsumi i energjisë në gjendjen FIKUR / NDEZUR: 0.3 W / 1.0 W
- Çelësi EM82 NUK ËSHTË I PAPËRSHTATSHËM për instalim në kuti të fshehura me një thellësi prej 45 mm dhe fole CUBO IP20.
- Çelësi është synuar për përdorim në ambiente të brendshme, me mbrojtje nga lagështira.

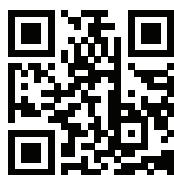
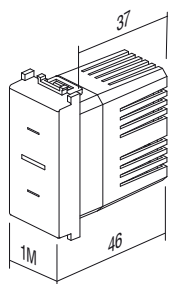

MULTIPURPOSE TIMER SWITCH EM82

- Supply voltage: 230 VAC, 50Hz
- Output: Rele 16 A / 250 V AC, 50Hz
- Wire cross section: 0,75 – 4.0 mm²
- Operating temperature: 0 to + 40 °C
- Storage temperature: -5 to + 60 °C
- Functions: **Timer, Relay (controlled switch), Switch, Push button**
- Program/status indication: RGB LED
- Number of buttons: 2
- Push button operation type: Capacitive
- Number of ports: 6 - 2x N, 2x L, 1x Output (L'), 1x Controlled input (S)
- Controlled input option: Yes. Connection of the main voltage signal (230 VAC) to terminal S.
- Implemented “zero crossing” operation (switching the switch when the voltage passes through 0 V)
- Power consumption in the OFF / ON state: 0.3 W / 1.0 W
- The EM82 switch is NOT SUITABLE for installation in concealed boxes with a depth of 45 mm and CUBO IP20 housing.
- The switch is intended for indoor use, protected from moisture.

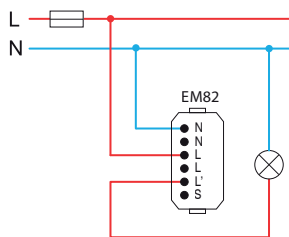
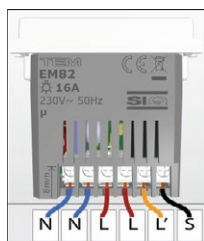
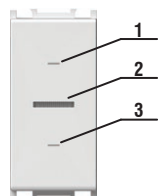

EM82 IS IN A SWITCH OR A TIMER MODE

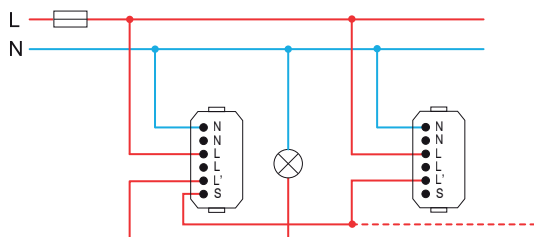

EM82-1 IS IN A SWITCH OR A TIMER MODE
EM82-2 IS IN A PUSH BUTTON MODE

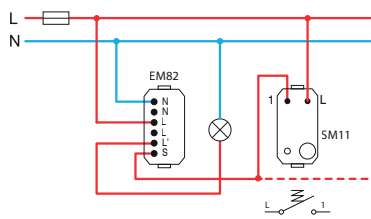

EM82 IS IN A SWITCH OR A TIMER MODE

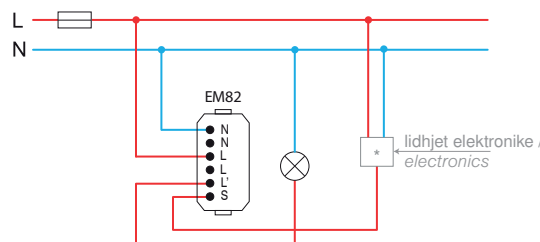

EM82 IS IN A RELAY MODE

	1	2	3	4	5	6	7	8
Max.	16 A	16 A	16 A	8 A	8 A5	A cos fi=0.6	200 VA	200 VA
	1 - incandescent lamp 2 - halogen lamp		3 - resistive heating element 4 - electronic transformer		5 - classical transformer 6 - motor		7 - energy saving CFL lamp	8 - LED lamp

OPERATION OF THE CONTROL SIGNAL S – MODE 1

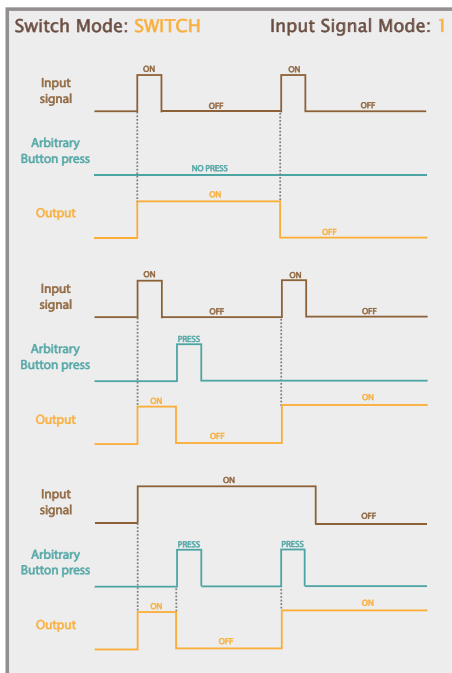

FIGURE 6: DISPLAY OF THE OPERATION OF THE EXTERNAL SIGNAL S AND BUTTONS IN THE SWITCH OPERATING MODE AND EXTERNAL SIGNAL IN MODE 1

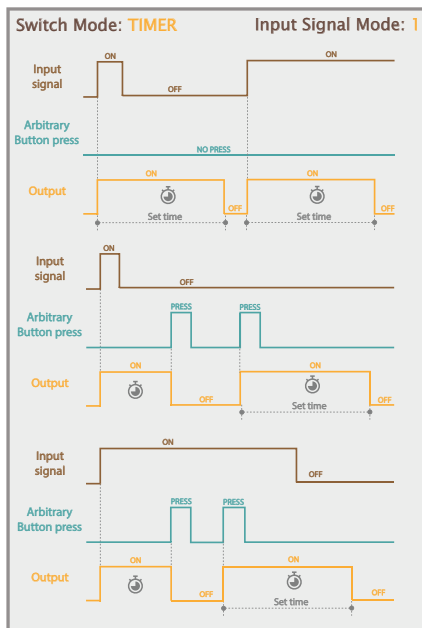

FIGURE 7: DISPLAY OF THE OPERATION OF THE EXTERNAL SIGNAL S AND BUTTONS IN THE TIMER OPERATING MODE AND EXTERNAL SIGNAL IN MODE 1

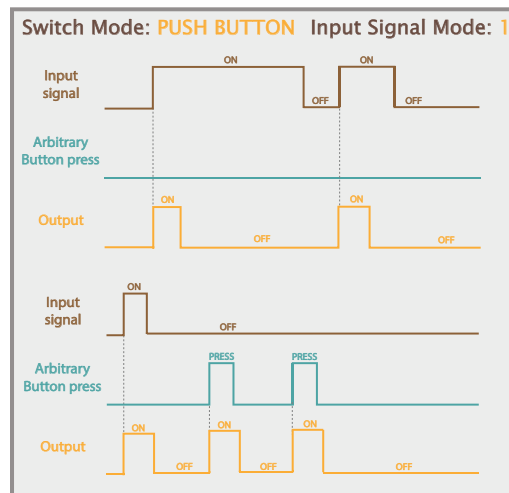

FIGURE 8: DISPLAY OF THE OPERATION OF THE EXTERNAL SIGNAL S AND BUTTONS IN THE PUSH BUTTON OPERATING MODE AND EXTERNAL SIGNAL IN MODE 1

OPERATION OF THE CONTROL SIGNAL S – MODE 2

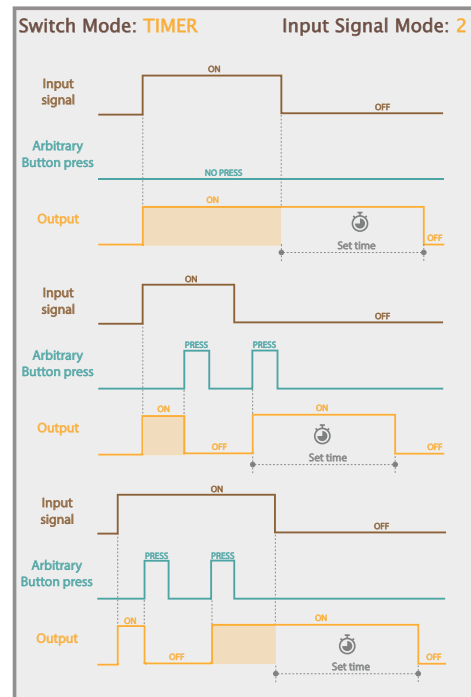

FIGURE 10: DISPLAY OF THE OPERATION OF THE EXTERNAL SIGNAL S AND BUTTONS IN THE TIMER OPERATING MODE AND EXTERNAL SIGNAL IN MODE 2

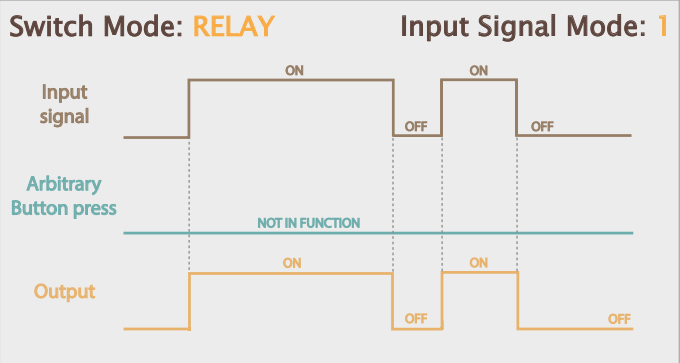

FIGURE 9: DISPLAY OF THE OPERATION OF THE EXTERNAL SIGNAL S AND BUTTONS IN THE RELAY OPERATING MODE AND EXTERNAL SIGNAL IN MODE 1

OPERATING MODE SETTINGS OF THE EXTERNAL CONTROL SIGNAL S

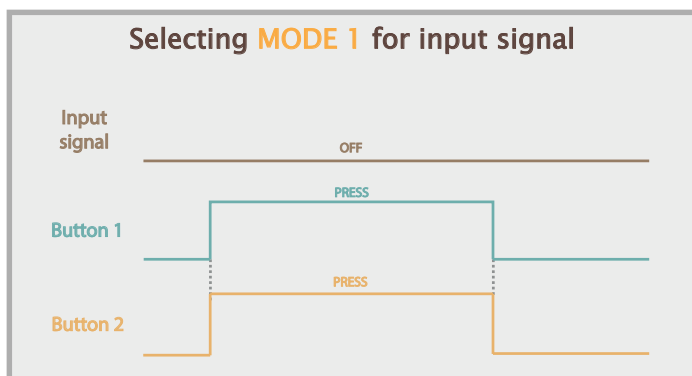

FIGURE 11: SETTING THE OPERATING MODE OF THE INPUT SIGNAL S FOR MODE 1

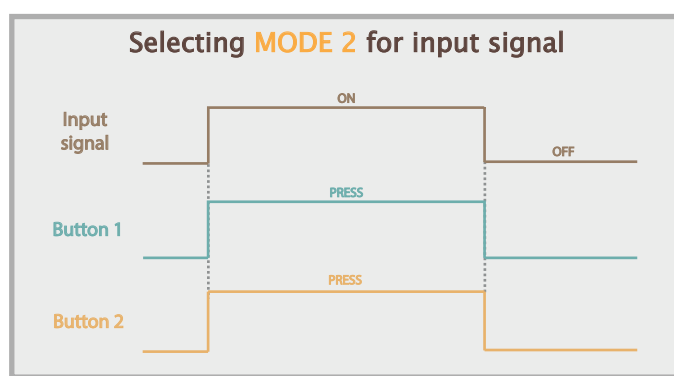

FIGURE 12: SETTING THE OPERATING MODE OF THE INPUT SIGNAL S FOR MODE 2

ÇELËS, PA PREKJE 10 A 240 V~



■ EM80GW

- çelës pa prekje për ndezje/fikje ("master")
- furnizimi me energji: 240 V~ 50 Hz
- releja e daljes 10 A / 250 V~ (2400 W në 240 V~)
- gama e rregullueshme nga 2 deri 10 cm
- për instalimin në kuti të rumbullakët standarde Ø60 mm
- për lidhjen kërkohet një tel nul (N)
- nuk është e mundur lidhja me çelës me 2 drejtime
- është e mundur lidhja me deri në 5 çelësa kontrolli EM81
- instalim i lehtë i kapakëve dekorativë me ndihmën e magnetëve
- shtrëngimi i vidave të telave deri në 2,5 mm² (maks. forca e shtrëngimit të vidës është 0,4 Nm)
- në përputhje me standardet EN 60669-1 dhe EN 60669-2-1
- vetëm për përdorim të brendshëm



SWITCH, TOUCHLESS 10A 240V~

- touchless switch for turning on/off ("master")
- power supply: 240 V~ 50 Hz
- output relay 10A / 250V~ (2400W at 240V~)
- adjustable range from 2 to 10 cm
- intended for installation into a standard round Ø60 mm box
- a neutral lead (N) is required for connection
- connection with toggle switches is not possible
- connection with up to 5 EM81 control switches is possible
- simple installation of decorative covers with the help of magnets
- screw fastening of leads up to 2,5 mm² (max. screw tightening torque is 0.4 Nm)
- in accordance with EN 60669-1 and EN 60669-2-1
- only for indoor use

ÇELËS, PA PREKJE, NJËSI KONTROLLI



■ EM81GW

- çelësi i kontrollit ("slave")
- funksionon vetëm kur lidhet me çelësin EM80 ("master")
- gama e rregullueshme nga 2 deri 10 cm
- instalim i lehtë i kapakëve dekorativë me ndihmën e magnetëve
- shtrëngimi i vidave të telave deri në 2,5 mm² (forca maks. e shtrëngimit të vidës është 0,4 Nm)
- në përputhje me standardet EN 60669-1 dhe EN 60669-2-1
- vetëm për përdorim të brendshëm



SWITCH, TOUCHLESS, CONTROL UNIT

- control switch ("slave")
- works only when connected with the EM80 switch ("master")
- adjustable range from 2 to 10 cm
- simple installation of decorative covers with the help of magnets
- screw fastening of leads up to 2.5 mm² (max. screw tightening torque is 0.4 Nm)
- in accordance with EN 60669-1 and EN 60669-2-1
- only for indoor use

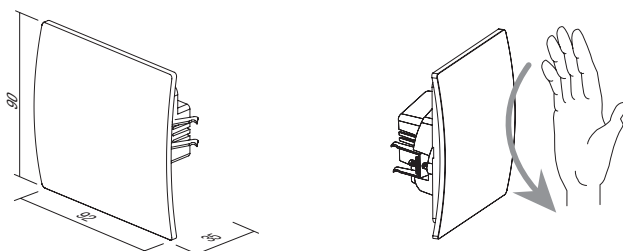
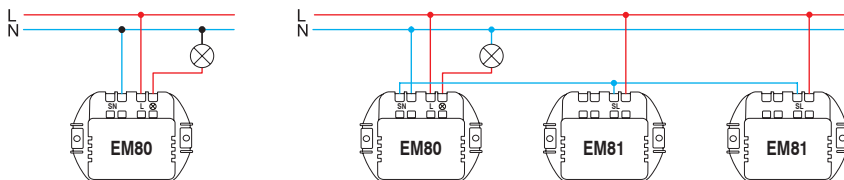

SINJALIZUES 8 VA 230 V~1M

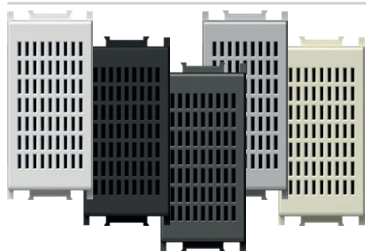

- EM90PW
- EM90MW
- EM90SB
- EM90AT
- EM90ES
- EM90IW

- sinjalizues
 - dalja e tingullit ka të njëjtën kohëzgjatje si funksionimi i kontrollit
 - tensioni i furnizimit, 230V ~ 50 Hz 8 VA
BUZZER 8VA 230V~1M
 - signal buzzer
 - the sound emission has the same lasting time as the control operation
 - supply voltage 230V~ 50Hz 8VA



SINJALIZUES 8 VA 12V~1M

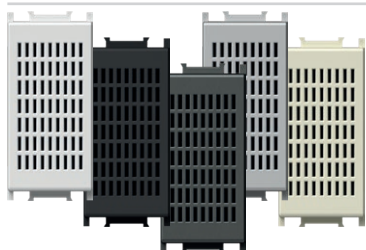

- EM91PW
- EM91MW
- EM91SB
- EM91AT
- EM91ES
- EM91IW

- sinjalizues
 - dalja e tingullit ka të njëjtën kohëzgjatje si funksionimi i kontrollit
 - tensioni i furnizimit, 230V ~ 50 Hz 8 VA
BUZZER 8VA 12V~1M
 - signal buzzer
 - the sound emission has the same lasting time as the control operation
 - supply voltage 12V~ 50Hz 8VA



ZILE 8 VA 230 V~1M

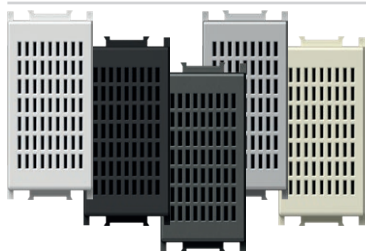

- EM92PW
- EM92MW
- EM92SB
- EM92AT
- EM92ES
- EM92IW

- zile sinjalizuese
 - dalja e tingullit ka të njëjtën kohëzgjatje si funksionimi i kontrollit
 - tensioni i furnizimit, 230V ~ 50 Hz 8 VA
BELL 8VA 230V~1M
 - signal bell
 - the sound emission has the same lasting time as the control operation
 - supply voltage 230V~ 50Hz 8VA



ZILE 8 VA 12V~1M

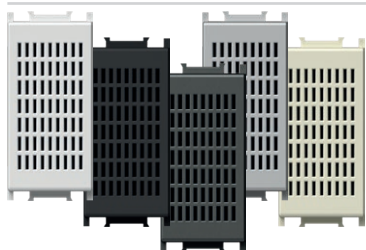

- EM93PW
- EM93MW
- EM93SB
- EM93AT
- EM93ES
- EM93IW

- zile sinjalizuese
 - dalja e tingullit ka të njëjtën kohëzgjatje si funksionimi i kontrollit
 - tensioni i furnizimit, 12V ~ 50 Hz 8 VA
BELL 8VA 12V~1M
 - signal bell
 - the sound emission has the same lasting time as the control operation
 - supply voltage 12V~ 50Hz 8VA

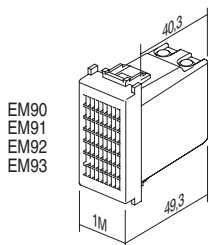

EM90
 EM91
 EM92
 EM93

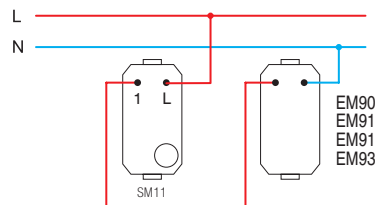

ZILE ELEKTRONIKE 230V~6mA rms 1M

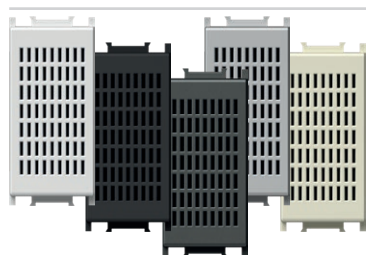

- EM94PW
- EM94MW
- EM94SB
- EM94AT
- EM94ES
- EM94IW

- Furnizimi me energji elektrike 230 V ~ 50/60 Hz
- Konsumi i melodisë 1: 4,7 mA rms
- Konsumi i melodisë 2: 5,9 mA rms
- Niveli i tingullit të melodisë 1: 90,5 dB
- Niveli i tingullit të melodisë 2: 86 dB
- Temperatura e funksionimit nga: 0°C deri në 45°C (përdorim i brendshëm)
- Temperatura e magazinimit nga -20°C deri në 50°C
- Klasa e mbrojtjes IP: IP20 (vetëm për përdorim të brendshëm)
- Klasa e sigurisë së pajisjes: II
- Kategoria e mbritensionit (EN 62109); klasa III
- Mbërthimi me vidë i përcjellësit, maks. 2,5 mm²
- Pajisja me distancë kontakti prej të paktën 3 mm
- Një çelës lehtësisht i aksesueshëm me stakim duhet të instalohet në pjesën e sipërme nga zilia
- në përputhje me direktivat EMC dhe LVD

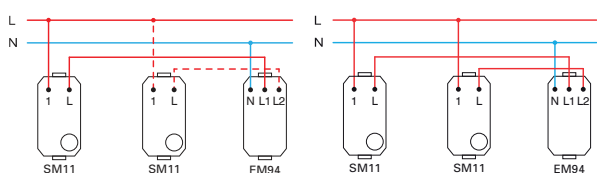

ELECTRONIC BELL 230V~6mA rms 1M

- power supply 230 V ~ 50/60 Hz
- power consumption when playing melody 1: 4.7 mA rms
- power consumption when playing melody 2: 5.9 mA rms
- sound level of melody 1: 90.5 dB
- sound level of melody 2: 86 dB
- operating temperature 0°C/45°C (indoor use)
- storage temperature: -20°C/50°C
- IP protection class: IP20 (indoor use only)
- class device II
- overvoltage category (EN62109): Class III
- screw contacts: max. 2.5 mm²
- device with a contact gap of at least 3 mm
- an easily accessible cut-off switch must be installed upstream from bell
- complies with EMC & LVD directives

KONTROLL VOLUMI 100 V LINJË AUDIO 35 W 2M



- EM95PW
- EM95MW
- EM95SB
- EM95AT
- EM95ES
- EM95IW

- kontroll volumi (atenuator) për sisteme audio 100 V
- vlerësimi i fuqisë 35 W (maks. 45 W), 6 hapa kontrolli volumi
- i përshtatshëm për kuti (min. 60 mm thellësi)
- i papërshtatshëm për instalim në kuti me thellësi 45 mm dhe kuti montimi në sipërfaqe CUBO IP20
- vetëm për përdorim të brendshëm

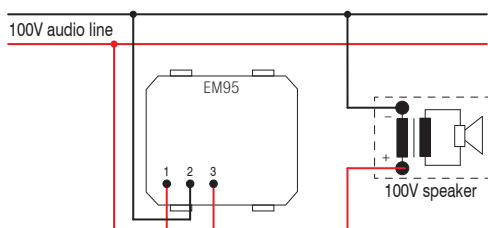

VOLUME CONTROL 100V AUDIO LINE 35W 2M

- volume control (attenuator) for 100V audio systems
- power rating 35W (max.45W), 6 steps volume control
- suitable for boxes min. 60 mm deep
- not suitable for installation in 45 mm deep boxes and surface mount boxes CUBO IP20
- for indoor use only

KONTROLL VOLUMI 4-8 Ω 35 W 2M

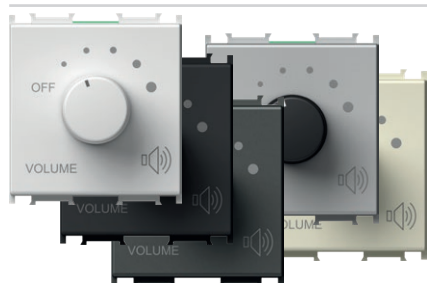

- EM96PW
- EM96MW
- EM96SB
- EM96AT
- EM96ES
- EM96IW

- kontroll volumi (atenuator) për dalje të tensionit të ulët 4-8 Ω, 35 W
- mundësi lidhjeje me pajisjet HI-FI
- fuqi nominale 35 W, kontroll i volumit me 6 hapa
- i përshtatshëm për kuti (min. 60 mm thellësi)
- i papërshtatshëm për instalim në kuti me thellësi 45 mm dhe kuti montimi në sipërfaqe CUBO IP20
- vetëm për përdorim të brendshëm

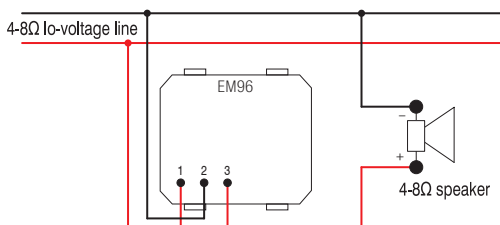

VOLUME CONTROL 4-8 Ω 35W 2M

- volume control (attenuator) for low voltage outputs 4-8 Ω, 35W
- power rating 35W, 6 steps volume control
- suitable for boxes min. 60 mm deep
- not suitable for installation in 45 mm deep boxes and surface mount boxes CUBO IP20
- for indoor use only

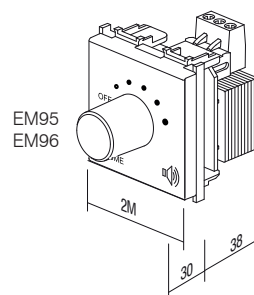

S E T S C M

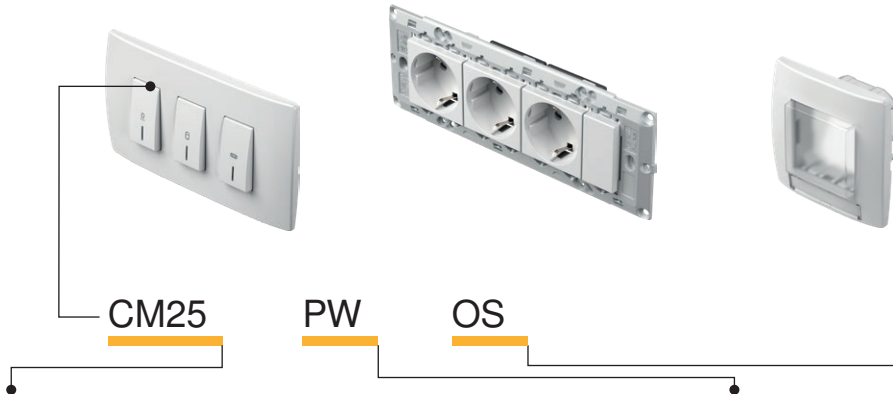

Iloji type	përshkrimi description	të dhënat teknike technical data	madhësia size	ngjyra colour	të dhënat opsionale 1 optional data 1
CM10	SET PRIZË 2x SCHUKO SOCKET SET 2x SCHUKO	2P+E 16A 250V~	4M	<input type="checkbox"/> PW e bardhë polare polar white	<input type="checkbox"/> OL kapak mbulues LINE cover plate LINE
CM11	SET PRIZË 3x SCHUKO SOCKET SET 3x SCHUKO	2P+E 16A 250V~	7M	<input type="checkbox"/> MW e bardhë mat matte white	<input type="checkbox"/> OS kapak mbulues SOFT cover plate SOFT
CM15	SET LIDHJEJE LINK WIRE SET	3x1.5mm ²	1M	<input checked="" type="checkbox"/> SB e zezë soft touch soft touch black	
·	·	·	·	<input checked="" type="checkbox"/> AT antracit anthracite	
·	·	·	·	<input type="checkbox"/> ES e argjendtë elox elox silver	
·	·	·	·	<input type="checkbox"/> IW e bardhë fildishi ivory white	

SET PRIZASH 2x SCHUKO 2P+E 16 A 250 V~ 4M

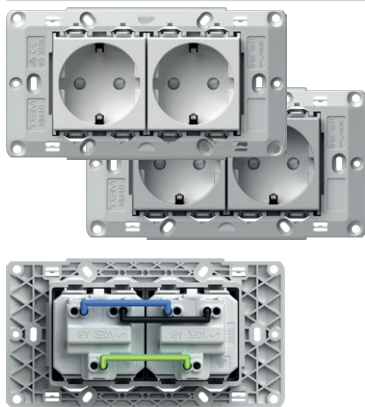

- CM10PW
- CM10ES

- set prizash 2x schuko VM10 2P+E 16 A 250 V~
- pajisur paraprakisht me lidhje telash CM16
- me kornizë montimi 4M pa vida
- për montimin e kornizës përdorni vida CM17, CM18 ose CM19
- kontaktet e vidave 1,5-2,5 mm²
- në përputhje me IEC 60884-1, CEE7

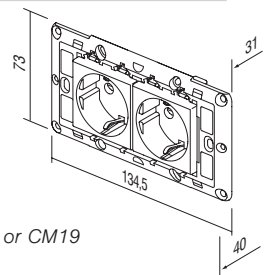

SOCKETS SET 2x SCHUKO 2P+E 16A 250V~ 4M

- socket set 2x schuko VM10 2P+E 16A 250V~
- prewired with link wires CM16
- with mounting frame 4M without screws
- for mounting frame fixing use screws CM17, CM18 or CM19
- screw contacts 1.5-2.5 mm²
- in accordance with IEC-60884-1, CEE7

SET PRIZASH 3x SCHUKO 2P+E 16 A 250 V~ 7M

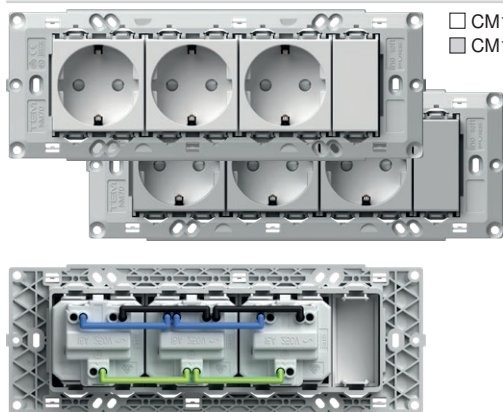

- CM11PW
- CM11ES

- set prizash 3x schuko VM10 2P+E 16 A 250 V~
- pajisur paraprakisht me lidhje telash CM16
- me kornizë montimi 7M pa vida
- për montimin e kornizës përdorni vida CM17, CM18 ose CM19
- kontaktet e vidave 1,5-2,5 mm²
- në përputhje me IEC 60884-1, CEE7

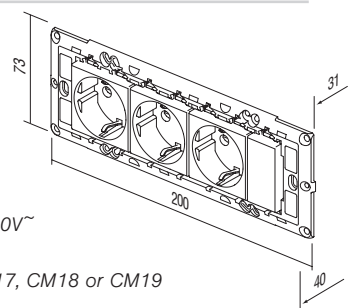

SOCKETS SET 3x SCHUKO 2P+E 16A 250V~ 7M

- socket set 3x schuko VM10 2P+E 16A 250V~
- prewired with link wires CM16
- with mounting frame 7M without screws
- for mounting frame fixing use screws CM17, CM18 or CM19
- screw contacts 1.5-2.5 mm²
- in accordance with IEC-60884-1, CEE7

SET LIDHJEJE 3x1,5 mm² 1M

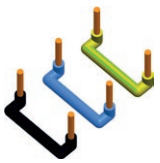

CM15

- set lidhjeje për të lidhur dy elemente madhësia 1M
- përfshin 10 tela të zi, 10 blu dhe 10 të verdhë/të gjelbër

LINK WIRE SET 3x1.5mm² 1M

- link wire set to connect two elements size 1M
- includes 10 black, 10 blue and 10 yellow/green wires

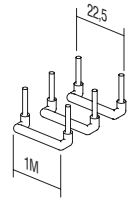

SET LIDHJEJE 3x2,5 mm² 2M

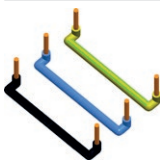

CM16

- set lidhjeje për të lidhur dy elemente madhësia 2M
- përfshin 10 tela të zi, 10 blu dhe 10 të verdhë/të gjelbër

LINK WIRE SET 3x2.5mm² 2M

- link wire set to connect two elements size 2M
- includes 10 black, 10 blue and 10 yellow/green wires

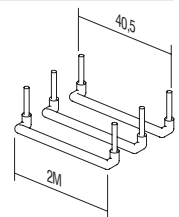

SET VIDASH 3,5



CM17
CM18
CM19

- set vidash për fiksimin e kornizave të montimit NM30, NM32, NM40, NM41, NM70
- CM17 - l=20mm, 100 copë
- CM18 - l=35mm, 50 copë
- CM19 - l=50mm, 50 copë

SCREW SET 3,5

- screw set for fixing mounting frames NM30, NM32, NM40, NM41, NM70
- CM17 - l=20mm, 100pcs
- CM18 - l=35mm, 50pcs
- CM19 - l=50mm, 50pcs

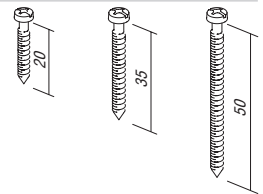

SET ÇELËSASH IP44 2M



- CM22PW
- CM22MW
- CM22SB
- CM22AT
- CM22ES
- CM22IW

- për përdorim në zona me lagështirë
- të gjithë çelësat Modul janë të pajisur me mbrojtje IP44
- çelësat dhe butonat nuk janë pjesë e setit
- kapak mbulues SOFT 2M me pllakë me mbishkrim
- në përputhje me IEC 60669-1

SET SWITCHES IP44 2M

- for usage in humid areas
- IP44 protection provides for all Modul switches
- switches and buttons are not part of the set
- SOFT 2M cover plate with inscription plate
- in accordance with IEC 60669-1



SET PRIZASH IP44 2M



- CM23PW
- CM23MW
- CM23SB
- CM23AT
- CM23ES
- CM23IW

- për përdorim në zona me lagështirë
- mbrojtja IP44 mund të arrihet vetëm në kombinim me prizën e mbuluar (VM11, VM41)
- prizat nuk janë pjesë e setit
- kapak mbulues SOFT 2M me pllakë me mbishkrim
- në përputhje me IEC 60884-1

SET SOCKETS IP44 2M

- for usage in humid areas
- IP44 protection can be achieved only in combination with covered socket (VM11, VM41)
- sockets are not part of the set
- SOFT 2M cover plate with inscription plate
- in accordance with IEC 60884-1



SET ÇELËSASH PËR BANJË 3x20 A 250 V~ 4M

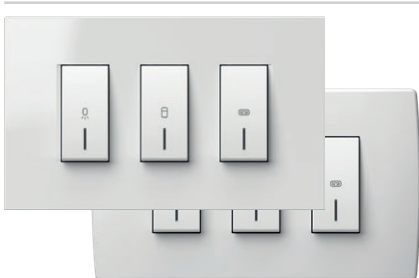

- CM25PWOL
- CM25IWOL
- CM25PWOS
- CM25IWOS

- set çelësash 3xSM12 20 A 250 V~ me kornizë montimi dhe kapak mbulues
- kontaktet e vidave 1,5-2,5 mm²
- në përputhje me EN 60669-1
- zgjidhje universale për rinovimin e kutive me dimensione fikse 108-135 mm ose kuti madhësia 4M
- kapak mbulues lartësia 90 mm

SWITCH SET FOR BATHROOM 3x20A 250V~ 4M

- switch set 3xSM12 20A 250V~ with mounting frame and cover plate
- screw contacts 1.5-2.5mm²
- in accordance with EN 60669-1
- universal solution for renovation on boxes with fixing dimensions 108-135mm or boxes 4M size
- cover plate height 90mm

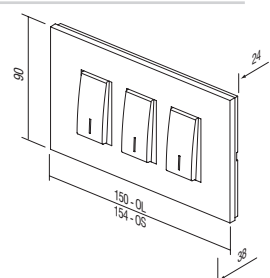



NM41

SET KORNIZË MONTIMI PËR BANJË 4M

- kornizë montimi universale për set banje me vida
- zgjidhje universale për montimin në kutitë drejtkëndore me dimensione fikse 108-135 mm ose kuti madhësia 4M
- në përputhje me EN 60669-1

MOUNTING FRAME BATHROOM SET 4M

- universal mounting frame for bathroom set with screws
- universal solution for mounting on rectangular boxes with fixing dimensions 108-135mm or boxes 4M size
- in accordance with EN 60669-1

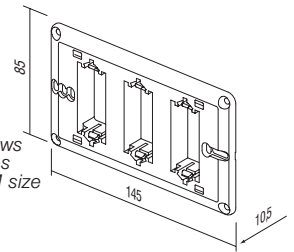

- | | |
|--|--------|
| | OL41PW |
| | OL41MW |
| | OL41NB |
| | OL41IW |
| | OL41ES |
| | OL41SG |
| | OL41IB |
| | OL41AT |
| | OL41TI |
| | OL41SB |

SETI KAPAKU MBULUES LINE PËR BANJË

- set dekorativ kapaku mbulues për banjë LINE
- lartësia 90 mm
- në përputhje me EN 60669-1

COVER PLATE LINE BATHROOM SET

- decorative cover plate bathroom set LINE
- height 90mm
- in accordance with EN 60669-1

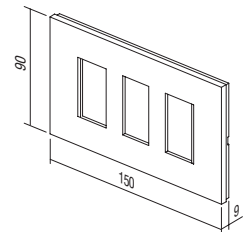

- | | | | |
|--|--------|--|--------|
| | OS41PW | | OS41SB |
| | OS41MW | | OS41WE |
| | OS41NB | | OS41AT |
| | OS41IW | | OS41TI |
| | OS41ES | | |
| | OS41SG | | |

SETI KAPAKU MBULUES SOFT PËR BANJË



- set dekorativ kapaku mbulues për banjë SOFT
- lartësia 90 mm
- në përputhje me EN 60669-1

COVER PLATE SOFT BATHROOM SET

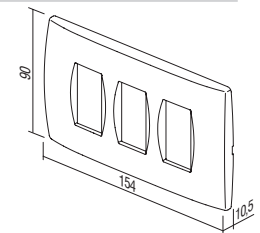
- decorative cover plate bathroom set SOFT
- height 90mm
- in accordance with EN 60669-1



PROGRAMI ANTIBAKTERIAL MODUL

Iloji type	përshkrimi description	madhësia size	ngjyra colour	të dhënat opsionale 1 optional data 1
TM11	BUTON BUTTON	1M	<input type="checkbox"/> AW e bardhë antibakteriale antibacterial white	 NT neutral  IN treguesi indicator
TM21	FALSO BLANK	1M		
VM10	PRIZË SOCKET	2M		
.	.	.		
.	.	.		

PROGRAMI ANTIBAKTERIAL MODUL

- çelësat dhe prizat preken çdo ditë nga shumë njerëz, prandaj janë një vend i zakonshëm për zhvillimin dhe përhapjen e baktereve
- falë karakteristikave të veta natyrale, argjendi është përdorur për tremijë vjet si dezinfektues i sigurt dhe efikas, duke qenë se është plotësisht natyral, i shëndetshëm dhe miqësor për mjedisin
- jonet speciale antibakteriale të argjendit ofrojnë mbrojtje afatgjatë, të qëndrueshme dhe efektive kundër zhvillimit dhe përhapjes së baktereve, mikrobeve dhe kërpudhave
- mbrojtja antibakteriale siguron higjienë, pastërti dhe shëndet për njerëzit
- programi antibakterial MODUL është plotësisht i përshtatshëm për përdorim në mjedise me kushte të rrepta higjienike (spitale, qendra shëndetësore, ambiente farmaceutike, azile pleqsh, laboratorë, restorante, hotele, aeroporte, stacione hekurudhore dhe autobusi, qendra biznesi dhe tregtare, institucione publike...)
- janë kryer testime të pavarura laboratorike në përputhje me standardet më të larta japoneze JIS Z 2801
- kosto e ulët për të siguruar shëndetin e njeriut
- dizajni dhe funksionimi i programit antibakterial MODUL lejon pastrim dhe mirëmbajtje të lehtë
- butonat antibakteriale, kapakët mbulues dhe prizat kombinohen me versione klasike të kornizave dhe çelësave
- produktet etiketohen në pjesën e pasme me AW (e bardhë antibakteriale)

ANTIBACTERIAL PROGRAM MODUL

- switches and sockets are daily touched by many people, so this is a common place for development and spread of bacteria
- thanks to its natural antibacterial characteristics silver has been used for three millennia as a safe and effective disinfectant, since it is completely natural, healthy and environmentally friendly
- special antibacterial silver ions additive provides long-term, reliable and effective protection against the development and spread of bacteria, microbes and fungi
- antibacterial protection ensures hygiene, cleanliness and health for people
- perfectly suitable for use in environments with strict hygiene conditions (hospitals, health centers, pharmaceutical facilities, homes for elderly, nursing homes, laboratories, restaurants, hotels, airports, bus and railway stations, business and shopping areas, public institutions ...)
- independent laboratory testings have been carried out in accordance with highest Japanese standards JIS Z 2801
- low cost for providing human health
- design and functionality of antibacterial program MODUL allow easy cleaning and maintenance
- antibacterial buttons, cover plates and sockets are combined with classic mounting frames and switches
- products are labelled on the back with AW (antibacterial white)

ANTIBACTERIAL PROGRAM MODUL

BUTON 1M



TM11AW

- buton i ndërrueshëm 1M
- në përputhje me EN 60669-1
- mbrojtje antibakteriale në përputhje me standardin JIS Z 2801

BUTTON 1M

- replaceable button 1M
- in accordance with EN 60669-1
- antibacterial protection in accordance with JIS Z 2801



TREGUES BUTONI 1M



TM11AWIN

- buton i ndërrueshëm 1M
- në përputhje me EN 60669-1
- mbrojtje antibakteriale në përputhje me standardin JIS Z 2801

BUTTON 1M INDICATOR

- replaceable button 1M
- in accordance with EN 60669-1
- antibacterial protection in accordance with JIS Z 2801



BUTON 2M



TM12AW

- buton i ndërrueshëm 2M me mbajtëse butoni
- për të përditësuar çelësin ose butonin me shtypje nga madhësia 1M në madhësinë 2M
- në përputhje me EN 60669-1
- mbrojtje antibakteriale në përputhje me standardin JIS Z 2801

BUTTON 2M

- replaceable button 2M with button carrier
- to upgrade switch or push button from size 1M to size 2M
- in accordance with EN 60669-1
- antibacterial protection in accordance with JIS Z 2801



TREGUES BUTONI 2M



TM12AWIN

- buton i ndërrueshëm 2M me mbajtëse butoni
- për të përditësuar çelësin ose butonin me shtypje nga madhësia 1M në madhësinë 2M
- në përputhje me EN 60669-1
- mbrojtje antibakteriale në përputhje me standardin JIS Z 2801

BUTTON 2M INDICATOR

- replaceable button 2M with button carrier
- to upgrade switch or push button from size 1M to size 2M
- in accordance with EN 60669-1
- antibacterial protection in accordance with JIS Z 2801



FALSO 1M



TM21AW

- modul falso për të mbushur hapësirat boshe
- në përputhje me EN 60669-1
- mbrojtje antibakteriale në përputhje me standardin JIS Z 2801

BLANK 1M

- blank modul to fill up empty spaces
- in accordance with EN 60669-1
- antibacterial protection in accordance with JIS Z 2801



FALSO 2M



TM22AW

- modul falso për të mbushur hapësirat boshe
- në përputhje me EN 60669-1
- mbrojtje antibakteriale në përputhje me standardin JIS Z 2801

BLANK 2M

- blank modul to fill up empty spaces
- in accordance with EN 60669-1
- antibacterial protection in accordance with JIS Z 2801

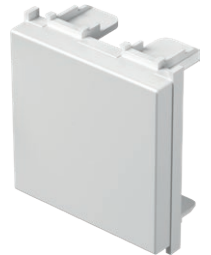



□ VM10AW

PRIZË SCHUKO+KS 2P+E 16 A 250 V~ 2M

- 2P+E schuko
- 16 A 250 V~, lloji VM10
- në përputhje me IEC 60884-1, CEE7
- kontaktet e vidave 1,5-2,5 mm²
- mbrojtje e integruar kontakti
- mbrojtje antibakteriale në përputhje me standardin JIS Z 2801

SOCKET SCHUKO+KS 2P+E 16A 250V~ 2M

- 2P+E schuko
- 16A 250V~, type VM10
- in accordance with IEC 60884-1, CEE7
- screw contacts 1.5-2.5 mm²
- built-in contact protection
- antibacterial protection in accordance with JIS Z 2801



□ VM11AW

PRIZË SCHUKO+KS+KAPAK 2P+E 16 A 250 V~ 2M

- 2P+E schuko+kapak
- 16 A 250 V~, lloji VM11
- në përputhje me IEC 60884-1, CEE7
- kontaktet e vidave 1,5-2,5 mm²
- mbrojtje e integruar kontakti
- mbrojtje antibakteriale në përputhje me standardin JIS Z 2801

SOCKET SCHUKO+KS+COVER

- 2P+E schuko+cover
- 16A 250V~, type VM11
- in accordance with IEC 60884-1, CEE7
- screw contacts 1.5-2.5 mm²
- built-in contact protection
- antibacterial protection in accordance with JIS Z 2801



□ VM20AW

PRIZË EURO+KS 2P 10A 250 V~ 1M

- 2P Euro
- 10A 250 V~, lloji VM20
- në përputhje me IEC 60884-1, CEE7
- kontaktet e vidave 1,5-2,5 mm²
- mbrojtje e integruar kontakti
- mbrojtje antibakteriale në përputhje me standardin JIS Z 2801

SOCKET EURO+KS 2P 10A 250V~ 1M

- 2P Euro
- 10A 250V~, type VM20
- in accordance with IEC 60884-1, CEE7
- screw contacts 1.5-2.5 mm²
- built-in contact protection
- antibacterial protection in accordance with JIS Z 2801



□ KM11AW

PRIZË TV ME KAPAK FUNDOR 1dB 1M

- TV me kapak fundor
- gama e frekuencës 5÷2400 MHz
- reduktimi < 1 dB
- në përputhje me EN 50083-1
- kontaktet e vidave
- mbrojtje antibakteriale në përputhje me standardin JIS Z 2801

SOCKET TV END-LINE 1dB 1M

- TV end-line
- frequency range 5÷2400 MHz
- reduction < 1 dB
- in accordance with EN 50083-1
- screw contacts
- antibacterial protection in accordance with JIS Z 2801

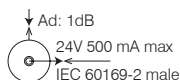

□ KM35AW

PËRSHTATËS KS 1M

- standard fiksues trapez KS
- AMP, Avaya, Brandrex, FMT, Mfico, Tyco, ...
- moduli i komunikimit nuk përfshihet
- mbrojtje antibakteriale në përputhje me standardin JIS Z 2801

ADAPTER KS 1M

- KS keystone fixing standard
- AMP, Avaya, Brandrex, FMT, Mfico, Tyco, ...
- communication module not included
- antibacterial protection in accordance with JIS Z 2801





OS20AW

KAPAK MBULUES SOFT 2M

- kapak mbulues dekorativ SOFT 2M
- në përputhje me EN 60669-1
- mbrojtje antibakteriale në përputhje me standardin JIS Z 2801

COVER PLATE SOFT 2M

- decorative cover plate SOFT 2M
- in accordance with EN 60669-1
- antibacterial protection in accordance with JIS Z 2801



OS24AW

KAPAK MBULUES SOFT 2x2M

- kapak mbulues dekorativ SOFT 2x2M
- montim horizontal ose vertikal
- në përputhje me EN 60669-1
- mbrojtje antibakteriale në përputhje me standardin JIS Z 2801

COVER PLATE SOFT 2x2M

- decorative cover plate SOFT 2x2M
- horizontal or vertical mounting
- in accordance with EN 60669-1
- antibacterial protection in accordance with JIS Z 2801



OS26AW

KAPAK MBULUES SOFT 3x2M

- kapak mbulues dekorativ SOFT 3x2M
- montim horizontal ose vertikal
- në përputhje me EN 60669-1
- mbrojtje antibakteriale në përputhje me standardin JIS Z 2801

COVER PLATE SOFT 3x2M

- decorative cover plate SOFT 3x2M
- horizontal or vertical mounting
- in accordance with EN 60669-1
- antibacterial protection in accordance with JIS Z 2801



OS30AW

KAPAK MBULUES SOFT 3M

- kapak mbulues dekorativ SOFT 3M
- në përputhje me EN 60669-1
- mbrojtje antibakteriale në përputhje me standardin JIS Z 2801

COVER PLATE SOFT 3M

- decorative cover plate SOFT 3M
- in accordance with EN 60669-1
- antibacterial protection in accordance with JIS Z 2801



OS40AW

KAPAK MBULUES SOFT 4M

- kapak mbulues dekorativ SOFT 4M
- në përputhje me EN 60669-1
- mbrojtje antibakteriale në përputhje me standardin JIS Z 2801

COVER PLATE SOFT 4M

- decorative cover plate SOFT 4M
- in accordance with EN 60669-1
- antibacterial protection in accordance with JIS Z 2801

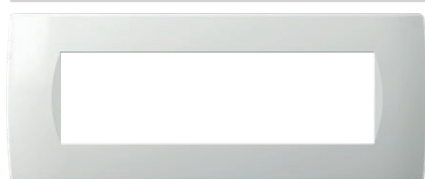

OS70AW

KAPAK MBULUES SOFT 7M

- kapak mbulues dekorativ SOFT 7M
- në përputhje me EN 60669-1
- mbrojtje antibakteriale në përputhje me standardin JIS Z 2801

COVER PLATE SOFT 7M

- decorative cover plate SOFT 7M
- in accordance with EN 60669-1
- antibacterial protection in accordance with JIS Z 2801

dru
wood

WB bambu
bamboo



WW arrë
walnut



WM panjë
maple



WE venge
wenge



Natyra është unike dhe e çmuar, sepse kapakët tanë mbulues dekorativë nuk janë dy njësoj.
Nuk mund të konsiderohen ankesat rreth pamjes diverse dhe ndryshimeve të kapakëve dekorativë prej druri.

Nature is unique and precious, as our decorative cover plates where no two are the same.
Complaints about wooden decorative cover plate's diverse appearance and differentiation cannot be considered.

C O V E R P L A T E S P U R E O P

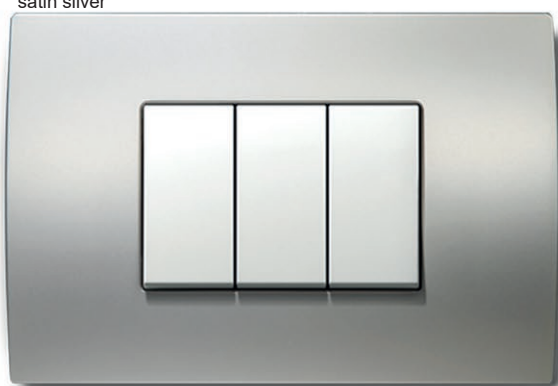
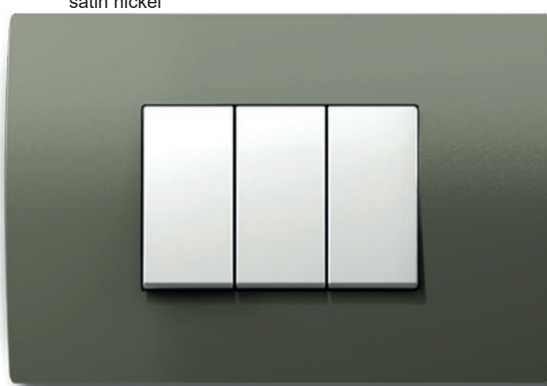
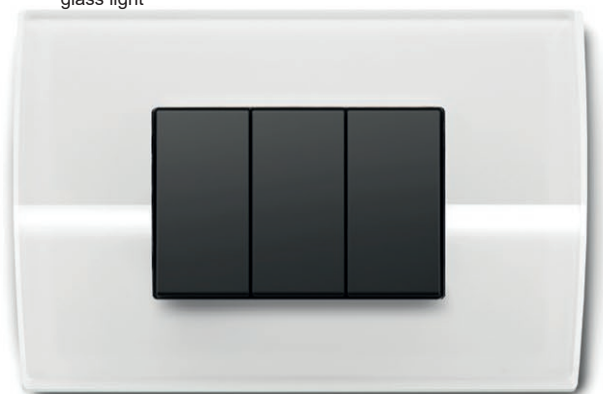
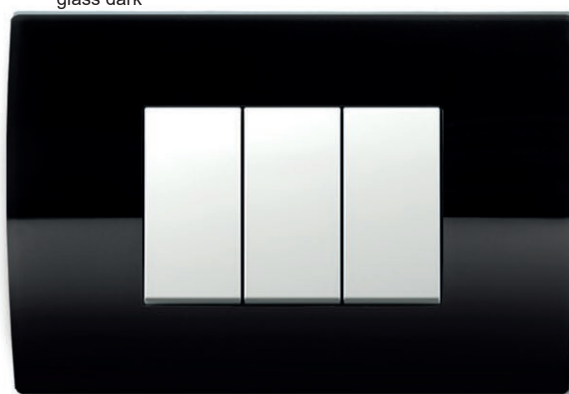
metal
metalMH çelik i rrahur
hammered steelME hekur i ngrënë
etched ironMS argjend satin
satin silverMN nikel satin
satin nickelxham
glassGL e bardhë
glass lightGD e zezë
glass dark



OP30

WB

lloji type	përshkrimi description	madhësia size	ngjyra colour					
OP13	KAPAK MBULUES PURE COVER PLATE PURE	1/3M	MH	çelik i rrahur hammered steel	WB	bambu bamboo	GL	e bardhë glass light
OP20	KAPAK MBULUES PURE COVER PLATE PURE	2M	ME	hekur i ngrënë etched iron	WW	arrë walnut	GD	e zezë glass dark
OP23	KAPAK MBULUES PURE COVER PLATE PURE	2/3M	MS	argjend satin satin silver	WM	panjë maple		
.	.	.	MN	nikel satin satin nickel	WE	venge wenge		



OP20MH	OP20WB
OP20ME	OP20WW
OP20MS	OP20WM
OP20MN	OP20GL
	OP20GD

KAPAK MBULUES PURE 2M

- kapak mbulues dekorativ PURE 2M
- në përputhje me EN 60669-1
- vetëm në kombinim me kornizë montimi NM24 ose NM25

COVER PLATE PURE 2M

- decorative cover plate PURE 2M
- in accordance with EN 60669-1
- only in combination with mounting frame NM24 or NM25

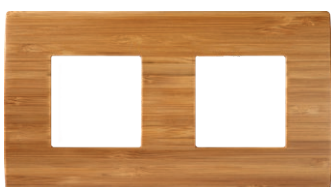

OP24MH	OP24WB
OP24ME	OP24WW
OP24MS	OP24WM
OP24MN	OP24GL
	OP24GD

KAPAK MBULUES PURE 2x2M

- kapak mbulues dekorativ PURE 2x2M
- montim horizontal ose vertikal
- në përputhje me EN 60669-1
- vetëm në kombinim me kornizë montimi NM24 ose NM25

COVER PLATE PURE 2x2M

- decorative cover plate PURE 2x2M
- horizontal or vertical mounting
- in accordance with EN 60669-1
- only in combination with mounting frames NM24 or NM25



OP26MH	OP26WB
OP26ME	OP26WW
OP26MS	OP26WM
OP26MN	OP26GL
	OP26GD

KAPAK MBULUES PURE 3x2M

- kapak mbulues dekorativ PURE 3x2M
- montim horizontal ose vertikal
- në përputhje me EN 60669-1
- vetëm në kombinim me kornizë montimi NM24 ose NM25

COVER PLATE PURE 3x2M

- decorative cover plate PURE 3x2M
- horizontal or vertical mounting
- in accordance with EN 60669-1
- only in combination with mounting frames NM24 or NM25



OP28MH	OP28WB
OP28ME	OP28WW
OP28MS	OP28WM
OP28MN	OP28GL
	OP28GD

KAPAK MBULUES PURE 4x2M

- kapak mbulues dekorativ PURE 4x2M
- montim horizontal ose vertikal
- në përputhje me EN 60669-1
- vetëm në kombinim me kornizë montimi NM24 ose NM25

COVER PLATE PURE 4x2M

- decorative cover plate PURE 4x2M
- horizontal or vertical mounting
- in accordance with EN 60669-1
- only in combination with mounting frames NM24 or NM25

COVER PLATES PURE OP



	OP30MH		OP30WB
	OP30ME		OP30WW
	OP30MS		OP30WM
	OP30MN		OP30WE
			OP30GL
			OP30GD

KAPAK MBULUES PURE 3M

- kapak mbulues dekorativ PURE 3M
- në përputhje me EN 60669-1

COVER PLATE PURE 3M

- decorative cover plate PURE 3M
- in accordance with EN 60669-1



	OP40MH		OP40WB
	OP40ME		OP40WW
	OP40MS		OP40WM
	OP40MN		OP40WE
			OP40GL
			OP40GD

KAPAK MBULUES PURE 4M

- kapak mbulues dekorativ PURE 4M
- në përputhje me EN 60669-1

COVER PLATE PURE 4M

- decorative cover plate PURE 4M
- in accordance with EN 60669-1



	OP70MH		OP70WB
	OP70ME		OP70WW
	OP70MS		OP70WM
	OP70MN		OP70WE
			OP70GL
			OP70GD

KAPAK MBULUES PURE 7M

- kapak mbulues dekorativ PURE 7M
- në përputhje me EN 60669-1

COVER PLATE PURE 7M

- decorative cover plate PURE 7M
- in accordance with EN 60669-1



	OP13MH		OP13WB
	OP13ME		OP13WW
	OP13MS		OP13WM
	OP13MN		OP13WE
			OP13GL
			OP13GD

KAPAK MBULUES PURE 1/3M

- kapak mbulues dekorativ PURE 1/3M
- në përputhje me EN 60669-1

COVER PLATE PURE 1/3M

- decorative cover plate PURE 1/3M
- in accordance with EN 60669-1



	OP23MH		OP23WB
	OP23ME		OP23WW
	OP23MS		OP23WM
	OP23MN		OP23WE
			OP23GL
			OP23GD

KAPAK MBULUES PURE 2/3M

- kapak mbulues dekorativ PURE 2/3M
- në përputhje me EN 60669-1

COVER PLATE PURE 2/3M

- decorative cover plate PURE 2/3M
- in accordance with EN 60669-1

bazë
basic

PW e bardhë polare
polar white

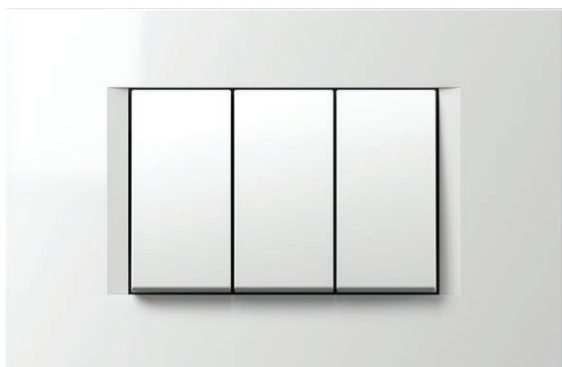

IW e bardhë fildishi
ivory white

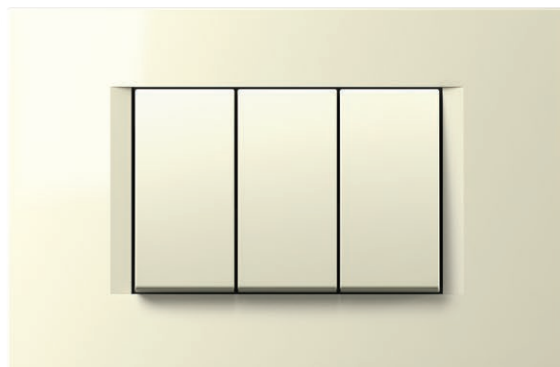

ES e argjendtë elox
elox silver



SB e zezë soft touch
soft touch black



AT antracit
anthracite

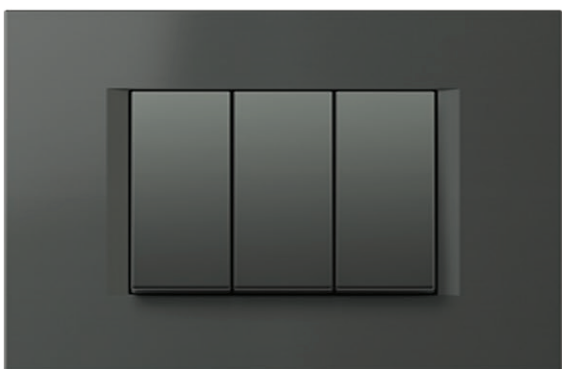

MW e bardhë mat
matte white

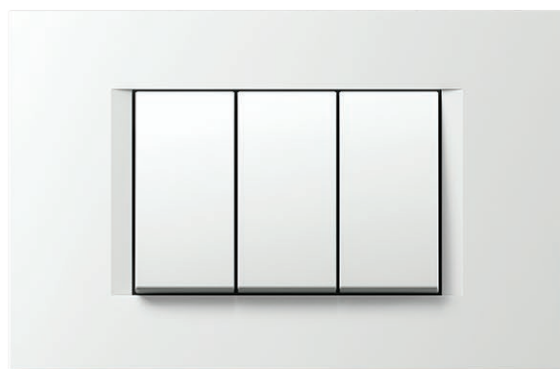

COVER PLATES LINE OL

dekor
decor

SG e artë ranore
sand gold

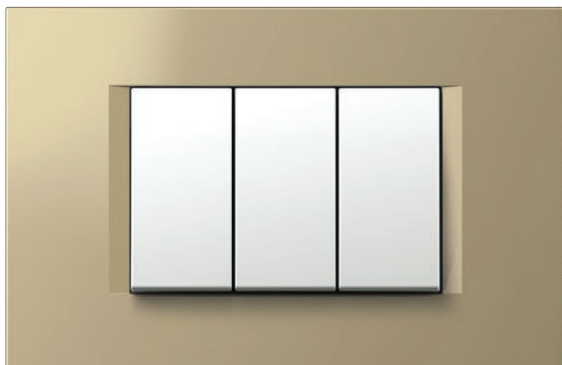

NB e zezë mesnate
night black

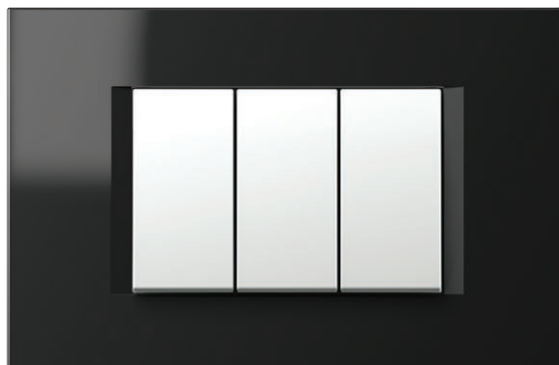

IB Impuls blu
impulse blue

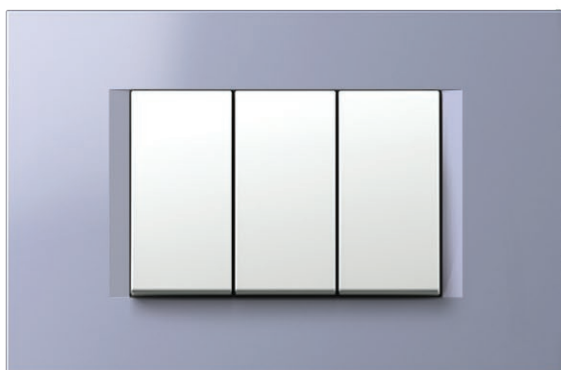

TI titan
titanium



SW e bardhë guri
stone white



KAPAK ËT MBULUES LINE OL

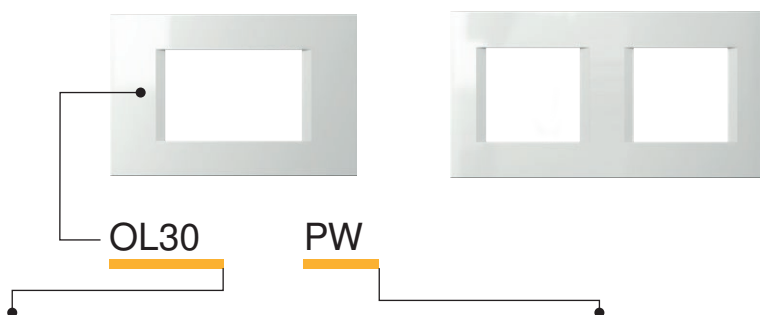

lloji type	përshkrimi description	madhësia size	ngjyra colour																		
OL10	KAPAK MBULUES LINE COVER PLATE LINE	1/2M	<table border="0"> <tr> <td></td> <td>PW e bardhë polare polar white</td> <td></td> <td>SG e artë ranore sand gold</td> <td></td> <td>AT antracit anthracite</td> </tr> </table>		PW e bardhë polare polar white		SG e artë ranore sand gold		AT antracit anthracite												
	PW e bardhë polare polar white		SG e artë ranore sand gold		AT antracit anthracite																
OL13	KAPAK MBULUES LINE COVER PLATE LINE	1/3M	<table border="0"> <tr> <td></td> <td>MW e bardhë mat matte white</td> <td></td> <td>NB e zezë mesnate night black</td> <td></td> <td>TI titan titanium</td> </tr> </table>		MW e bardhë mat matte white		NB e zezë mesnate night black		TI titan titanium												
	MW e bardhë mat matte white		NB e zezë mesnate night black		TI titan titanium																
OL20	KAPAK MBULUES LINE COVER PLATE LINE	2M	<table border="0"> <tr> <td></td> <td>IW e bardhë fildishi ivory white</td> <td></td> <td>IB Impuls blu impulse blue</td> <td></td> <td>SW e bardhë guri stone white</td> </tr> <tr> <td></td> <td>ES e argjendtë elox elox silver</td> <td></td> <td></td> <td></td> <td></td> </tr> <tr> <td></td> <td>SB e zezë soft touch soft touch black</td> <td></td> <td></td> <td></td> <td></td> </tr> </table>		IW e bardhë fildishi ivory white		IB Impuls blu impulse blue		SW e bardhë guri stone white		ES e argjendtë elox elox silver						SB e zezë soft touch soft touch black				
	IW e bardhë fildishi ivory white		IB Impuls blu impulse blue		SW e bardhë guri stone white																
	ES e argjendtë elox elox silver																				
	SB e zezë soft touch soft touch black																				



KAPAK MBULUES LINE 2M



	OL20PW		OL20SG
	OL20MW		OL20NB
	OL20IW		OL20IB
	OL20ES		OL20AT
	OL20SB		OL20TI
			OL20SW

- kapak mbulues dekorativ LINE 2M
- në përputhje me EN 60669-1

COVER PLATE LINE 2M

- decorative cover plate LINE 2M
- in accordance with EN 60669-1

KAPAK MBULUES LINE 2x2M

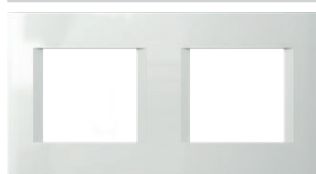

	OL24PW		OL24SG
	OL24MW		OL24NB
	OL24IW		OL24IB
	OL24ES		OL24AT
	OL24SB		OL24TI
			OL24SW

- kapak mbulues dekorativ LINE 2x2M
- montim horizontal ose vertikal
- në përputhje me EN 60669-1

COVER PLATE LINE 2x2M

- decorative cover plate LINE 2x2M
- horizontal or vertical mounting
- in accordance with EN 60669-1

KAPAK MBULUES LINE 3x2M

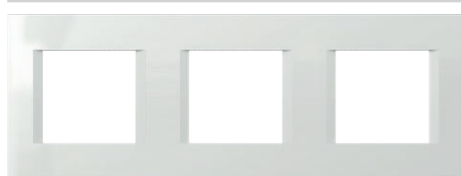

	OL26PW		OL26SG
	OL26MW		OL26NB
	OL26IW		OL26IB
	OL26ES		OL26AT
	OL26SB		OL26TI
			OL26SW

- kapak mbulues dekorativ LINE 3x2M
- montim horizontal ose vertikal
- në përputhje me EN 60669-1

COVER PLATE LINE 3x2M

- decorative cover plate LINE 3x2M
- horizontal or vertical mounting
- in accordance with EN 60669-1

KAPAK MBULUES LINE 4x2M



	OL28PW		OL28SG
	OL28MW		OL28NB
	OL28IW		OL28IB
	OL28ES		OL28AT
	OL28SB		OL28TI
			OL28SW

- kapak mbulues dekorativ LINE 4x2M
- montim horizontal ose vertikal
- në përputhje me EN 60669-1

COVER PLATE LINE 4x2M

- decorative cover plate LINE 4x2M
- horizontal or vertical mounting
- in accordance with EN 60669-1

KAPAK MBULUES LINE 5x2M

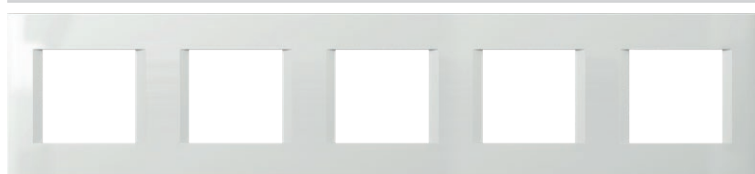

	OL29PW
	OL29MW
	OL29IW
	OL29ES
	OL29SB
	OL29AT
	OL29TI

- kapak mbulues dekorativ LINE 5x2M
- montim horizontal ose vertikal
- në përputhje me EN 60669-1

COVER PLATE LINE 5x2M

- decorative cover plate LINE 5x2M
- horizontal or vertical mounting
- in accordance with EN 60669-1

MODUL

LINE

COVER PLATES LINE OL

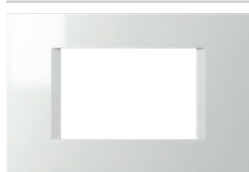

	OL30PW		OL30SG
	OL30MW		OL30NB
	OL30IW		OL30IB
	OL30ES		OL30AT
	OL30SB		OL30TI
			OL30SW

KAPAK MBULUES LINE 3M

- kapak mbulues dekorativ LINE 3M
- në përputhje me EN 60669-1

COVER PLATE LINE 3M

- decorative cover plate LINE 3M
- in accordance with EN 60669-1

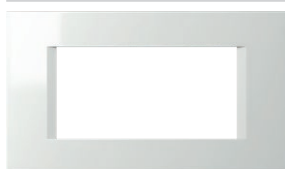

	OL40PW		OL40SG
	OL40MW		OL40NB
	OL40IW		OL40IB
	OL40ES		OL40AT
	OL40SB		OL40TI
			OL40SW

KAPAK MBULUES LINE 4M

- kapak mbulues dekorativ LINE 4M
- në përputhje me EN 60669-1

COVER PLATE LINE 4M

- decorative cover plate LINE 4M
- in accordance with EN 60669-1

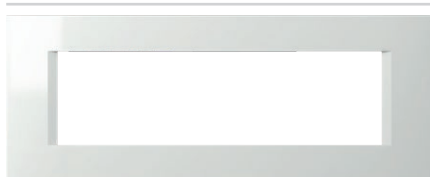

	OL70PW		OL70SG
	OL70MW		OL70NB
	OL70IW		OL70IB
	OL70ES		OL70AT
	OL70SB		OL70TI
			OL70SW

KAPAK MBULUES LINE 7M

- kapak mbulues dekorativ LINE 7M
- në përputhje me EN 60669-1

COVER PLATE LINE 7M

- decorative cover plate LINE 7M
- in accordance with EN 60669-1



	OL71PW		OL71AT
	OL71MW		OL71TI
	OL71IW		
	OL71ES		
	OL71SB		

KAPAK MBULUES LINE 2x7M

- kapak mbulues dekorativ LINE 2x7M
- në përputhje me EN 60669-1

COVER PLATE LINE 2x7M

- decorative cover plate LINE 2x7M
- in accordance with EN 60669-1



	OL10PW		OL10SG
	OL10MW		OL10NB
	OL10IW		OL10IB
	OL10ES		OL10AT
	OL10SB		OL10TI
			OL10SW

KAPAK MBULUES LINE 1/2M

- kapak mbulues dekorativ LINE 1/2M
- në përputhje me EN 60669-1

COVER PLATE LINE 1/2M

- decorative cover plate LINE 1/2M
- in accordance with EN 60669-1

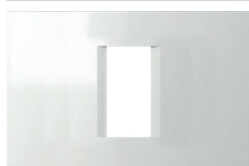

	OL13PW		OL13SG
	OL13MW		OL13NB
	OL13IW		OL13IB
	OL13ES		OL13AT
	OL13SB		OL13TI
			OL13SW

KAPAK MBULUES LINE 1/3M

- kapak mbulues dekorativ LINE 1/3M
- në përputhje me EN 60669-1

COVER PLATE LINE 1/3M

- decorative cover plate LINE 1/3M
- in accordance with EN 60669-1

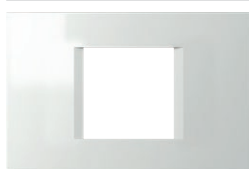

	OL23PW		OL23SG
	OL23MW		OL23NB
	OL23IW		OL23IB
	OL23ES		OL23AT
	OL23SB		OL23TI
			OL23SW

KAPAK MBULUES LINE 2/3M

- kapak mbulues dekorativ LINE 2/3M
- në përputhje me EN 60669-1

COVER PLATE LINE 2/3M

- decorative cover plate LINE 2/3M
- in accordance with EN 60669-1

bazë
basic

PW e bardhë polare
polar white

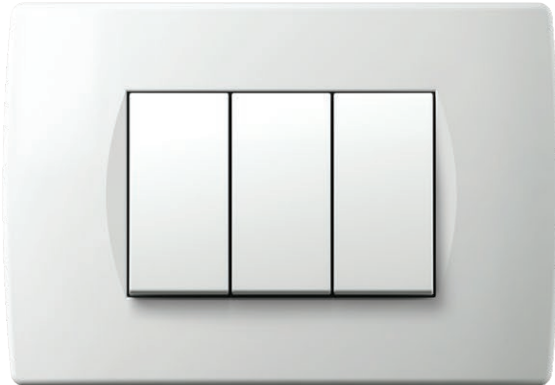

IW e bardhë fildishi
ivory white

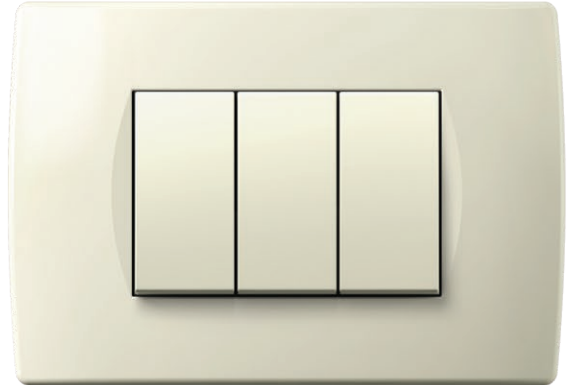

ES e argjendtë elox
elox silver

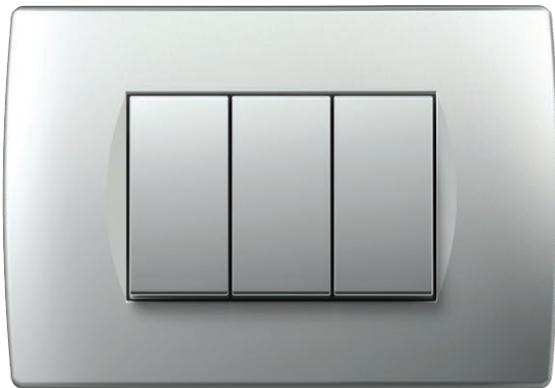

SB e zezë soft touch
soft touch black



AT antracit
anthracite



MW e bardhë mat
matte white

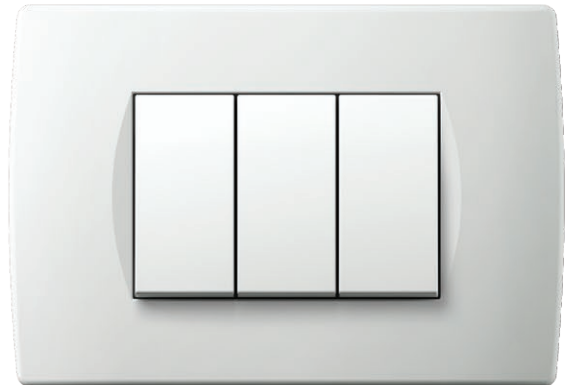

COVER PLATES SOFT OS

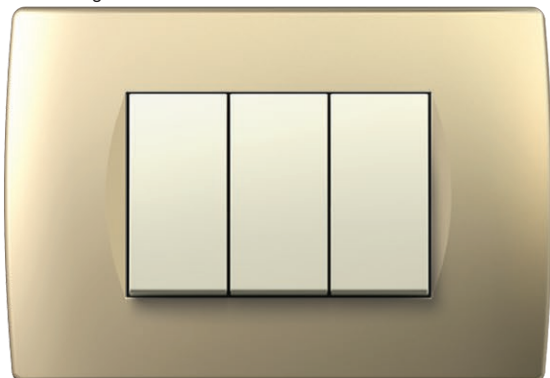
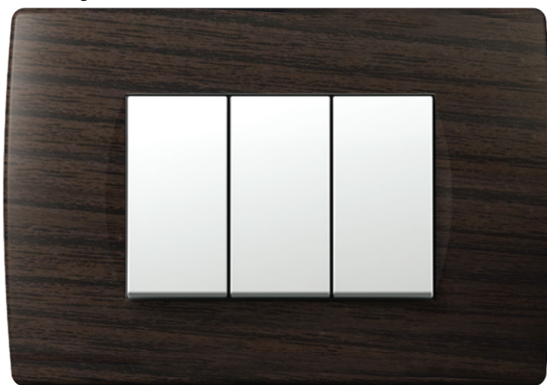
dekor
decorSG e artë ranore
sand goldNB e zezë mesnate
night blackTI titan
titaniumWE venge
wengeWW arrë
walnut



OS30



PW

lloji type	përshkrimi description	madhësia size	ngjyra colour																		
OS10	KAPAK MBULUES SOFT COVER PLATE SOFT	1/2M	<table border="0"> <tr> <td></td> <td>PW e bardhë polare polar white</td> <td></td> <td>SG e artë ranore sand gold</td> <td></td> <td>WW arrë walnut</td> </tr> </table>		PW e bardhë polare polar white		SG e artë ranore sand gold		WW arrë walnut												
	PW e bardhë polare polar white		SG e artë ranore sand gold		WW arrë walnut																
OS13	KAPAK MBULUES SOFT COVER PLATE SOFT	1/3M	<table border="0"> <tr> <td></td> <td>MW e bardhë mat matte white</td> <td></td> <td>NB e zezë mesnate night black</td> <td></td> <td>WE venge wenge</td> </tr> </table>		MW e bardhë mat matte white		NB e zezë mesnate night black		WE venge wenge												
	MW e bardhë mat matte white		NB e zezë mesnate night black		WE venge wenge																
OS20	KAPAK MBULUES SOFT COVER PLATE SOFT	2M	<table border="0"> <tr> <td></td> <td>IW e bardhë fildishi ivory white</td> <td></td> <td>AT antracit anthracite</td> <td></td> <td></td> </tr> <tr> <td></td> <td>ES e argjendtë elox elox silver</td> <td></td> <td>TI titan titanium</td> <td></td> <td></td> </tr> <tr> <td></td> <td>SB e zezë soft touch soft touch black</td> <td></td> <td></td> <td></td> <td></td> </tr> </table>		IW e bardhë fildishi ivory white		AT antracit anthracite				ES e argjendtë elox elox silver		TI titan titanium				SB e zezë soft touch soft touch black				
	IW e bardhë fildishi ivory white		AT antracit anthracite																		
	ES e argjendtë elox elox silver		TI titan titanium																		
	SB e zezë soft touch soft touch black																				
.	.	.	.																		
.	.	.	.																		



	OS20PW		OS20SG
	OS20MW		OS20NB
	OS20IW		OS20AT
	OS20ES		OS20TI
	OS20SB		OS20WW
			OS20WE

KAPAK MBULUES SOFT 2M

- kapak mbulues dekorativ SOFT 2M
- në përputhje me EN 60669-1

COVER PLATE SOFT 2M

- decorative cover plate SOFT 2M
- in accordance with EN 60669-1



	OS24PW		OS24SG
	OS24MW		OS24NB
	OS24IW		OS24AT
	OS24ES		OS24TI
	OS24SB		OS24WW
			OS24WE

KAPAK MBULUES SOFT 2x2M

- kapak mbulues dekorativ SOFT 2x2M
- montim horizontal ose vertikal
- në përputhje me EN 60669-1

COVER PLATE SOFT 2x2M

- decorative cover plate SOFT 2x2M
- horizontal or vertical mounting
- in accordance with EN 60669-1

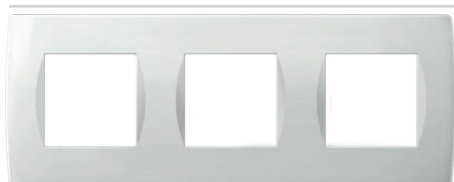

	OS26PW		OS26SG
	OS26MW		OS26NB
	OS26IW		OS26AT
	OS26ES		OS26TI
	OS26SB		OS26WW
			OS26WE

KAPAK MBULUES SOFT 3x2M

- kapak mbulues dekorativ SOFT 3x2M
- montim horizontal ose vertikal
- në përputhje me EN 60669-1

COVER PLATE SOFT 3x2M

- decorative cover plate SOFT 3x2M
- horizontal or vertical mounting
- in accordance with EN 60669-1



	OS28PW		OS28SG
	OS28MW		OS28NB
	OS28IW		OS28AT
	OS28ES		OS28TI
	OS28SB		OS28WW
			OS28WE

KAPAK MBULUES SOFT 4x2M

- kapak mbulues dekorativ SOFT 4x2M
- montim horizontal ose vertikal
- në përputhje me EN 60669-1

COVER PLATE SOFT 4x2M

- decorative cover plate SOFT 4x2M
- horizontal or vertical mounting
- in accordance with EN 60669-1

MODUL

SOFT

C O V E R P L A T E S S O F T O S

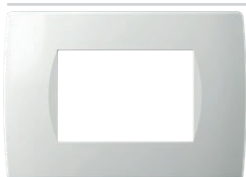

	OS30PW		OS30SG
	OS30MW		OS30NB
	OS30IW		OS30AT
	OS30ES		OS30TI
	OS30SB		OS30WW
			OS30WE

KAPAK MBULUES SOFT 3M

- kapak mbulues dekorativ SOFT 3M
- në përputhje me EN 60669-1

COVER PLATE SOFT 3M

- decorative cover plate SOFT 3M
- in accordance with EN 60669-1



	OS40PW		OS40SG
	OS40MW		OS40NB
	OS40IW		OS40AT
	OS40ES		OS40TI
	OS40SB		OS40WW
			OS40WE

KAPAK MBULUES SOFT 4M

- kapak mbulues dekorativ SOFT 4M
- në përputhje me EN 60669-1

COVER PLATE SOFT 4M

- decorative cover plate SOFT 4M
- in accordance with EN 60669-1

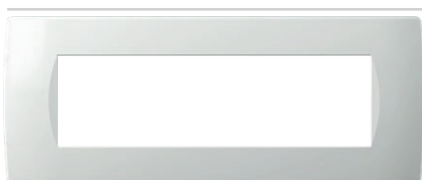

	OS70PW		OS70SG
	OS70MW		OS70NB
	OS70IW		OS70AT
	OS70ES		OS70TI
	OS70SB		OS70WW
			OS70WE







KAPAK MBULUES SOFT 7M

- kapak mbulues dekorativ SOFT 7M
- në përputhje me EN 60669-1

COVER PLATE SOFT 7M

- decorative cover plate SOFT 7M
- in accordance with EN 60669-1



	OS71PW		OS71AT
	OS71MW		OS71TI
	OS71IW		
	OS71ES		
	OS71SB		







KAPAK MBULUES SOFT 2x7M

- kapak mbulues dekorativ SOFT 7x2M
- në përputhje me EN 60669-1

COVER PLATE SOFT 2x7M

- decorative cover plate SOFT 2x7M
- in accordance with EN 60669-1



	OS72PW		OS72SG
	OS72IW		OS72AT
	OS72ES		OS72TI
	OS72SB		

KAPAK MBULUES SOFT 2x7M

- kapak mbulues dekorativ SOFT 7x2M
me plakë me mbishkrim
- në përputhje me EN 60669-1

COVER PLATE SOFT 2x7M

- decorative cover plate SOFT 2x7M
with inscription plate
- in accordance with EN 60669-1



 OS10PW	 OS10SG
 OS10MW	 OS10NB
 OS10IW	 OS10AT
 OS10ES	 OS10TI
 OS10SB	 OS10WW
	 OS10WE









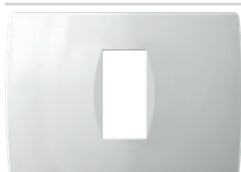

KAPAK MBULUES SOFT 1/2M

- kapak mbulues dekorativ SOFT 1/2M
- në përputhje me EN 60669-1

COVER PLATE SOFT 1/2M

- decorative cover plate SOFT 1/2M
- in accordance with EN 60669-1



 OS13PW	 OS13SG
 OS13MW	 OS13NB
 OS13IW	 OS13AT
 OS13ES	 OS13TI
 OS13SB	 OS13WW
	 OS13WE

KAPAK MBULUES SOFT 1/3M

- kapak mbulues dekorativ SOFT 1/3M
- në përputhje me EN 60669-1

COVER PLATE SOFT 1/3M

- decorative cover plate SOFT 1/3M
- in accordance with EN 60669-1

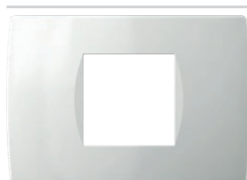

 OS23PW	 OS23SG
 OS23MW	 OS23NB
 OS23IW	 OS23AT
 OS23ES	 OS23TI
 OS23SB	 OS23WW
	 OS23WE

KAPAK MBULUES SOFT 2/3M

- kapak mbulues dekorativ SOFT 2/3M
- në përputhje me EN 60669-1

COVER PLATE SOFT 2/3M

- decorative cover plate SOFT 2/3M
- in accordance with EN 60669-1

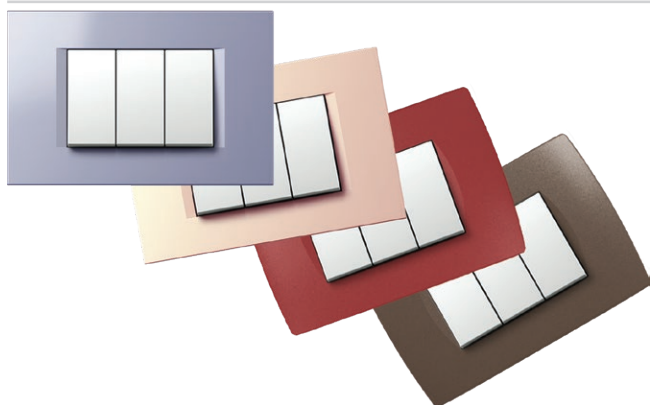











ZBUKURIMET E KAPAKËVE MBULUES

- kur porosini sasi të mëdha, kapakët mbulues mund të bëhen në ngjyrën që ju zgjidhni
- i përshtatshëm për kapakët mbulues OL, OS

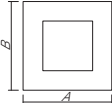
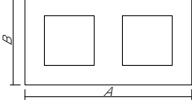
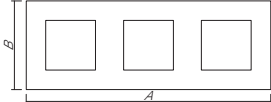
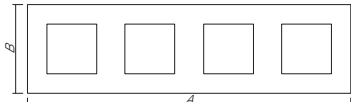
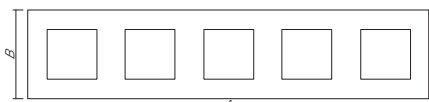
COVER PLATES DECORATIONS

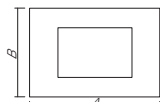
- when ordering large quantities, cover plates can be made in the colour of your choice
- suitable for cover plates OL, OS

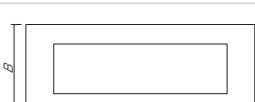
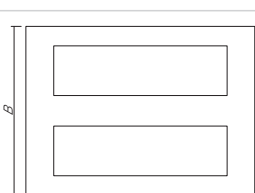
F R A M E S

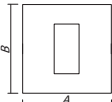
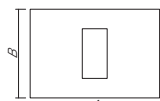
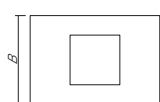
	 MODUL LINE A x B	 MODUL SOFT A x B	 MODUL PURE A x B
2M 	80 x 80 mm	84 x 84 mm	93 x 90 mm
2x2M 	151 x 80 mm	155 x 84 mm	164 x 90 mm
3x2M 	222 x 80 mm	226 x 84 mm	235 x 90 mm
4x2M 	293 x 80 mm	297 x 84 mm	304 x 90 mm
5x2M 	364,1 x 80 mm		
			
3M 	122 x 80 mm	122 x 84 mm	134 x 90 mm
4M 	149 x 80 mm	144 x 84 mm	157 x 90 mm
7M 	207 x 80 mm	212 x 84 mm	224 x 90 mm
2x7M 	215 x 159 mm	212 x 158 mm	
			
1/2M 	80 x 80 mm	84 x 84 mm	
1/3M 	122 x 80 mm	122 x 84 mm	134 x 90 mm
2/3M 	122 x 80 mm	122 x 84 mm	134 x 90 mm

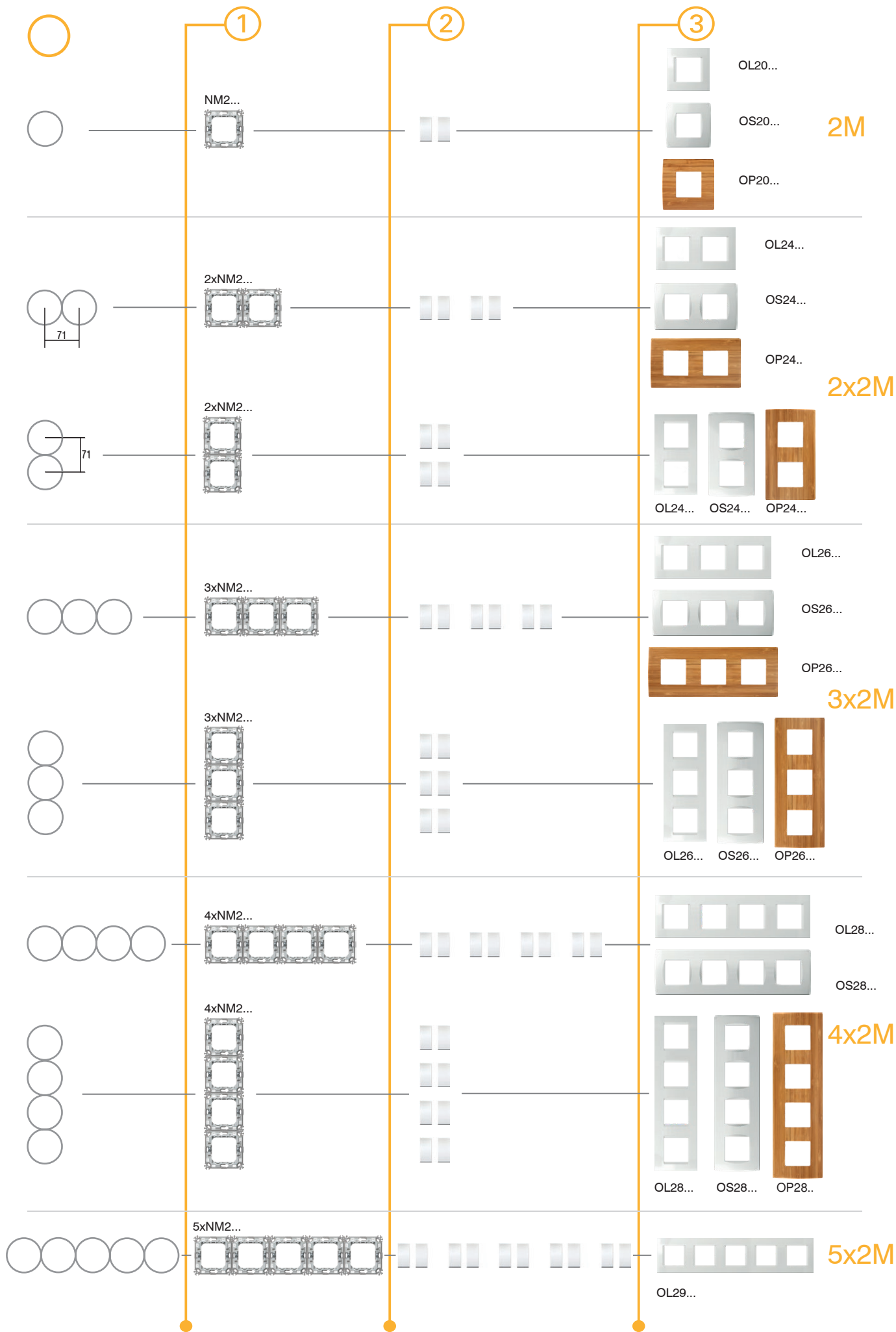

C O M B I N A T I O N S

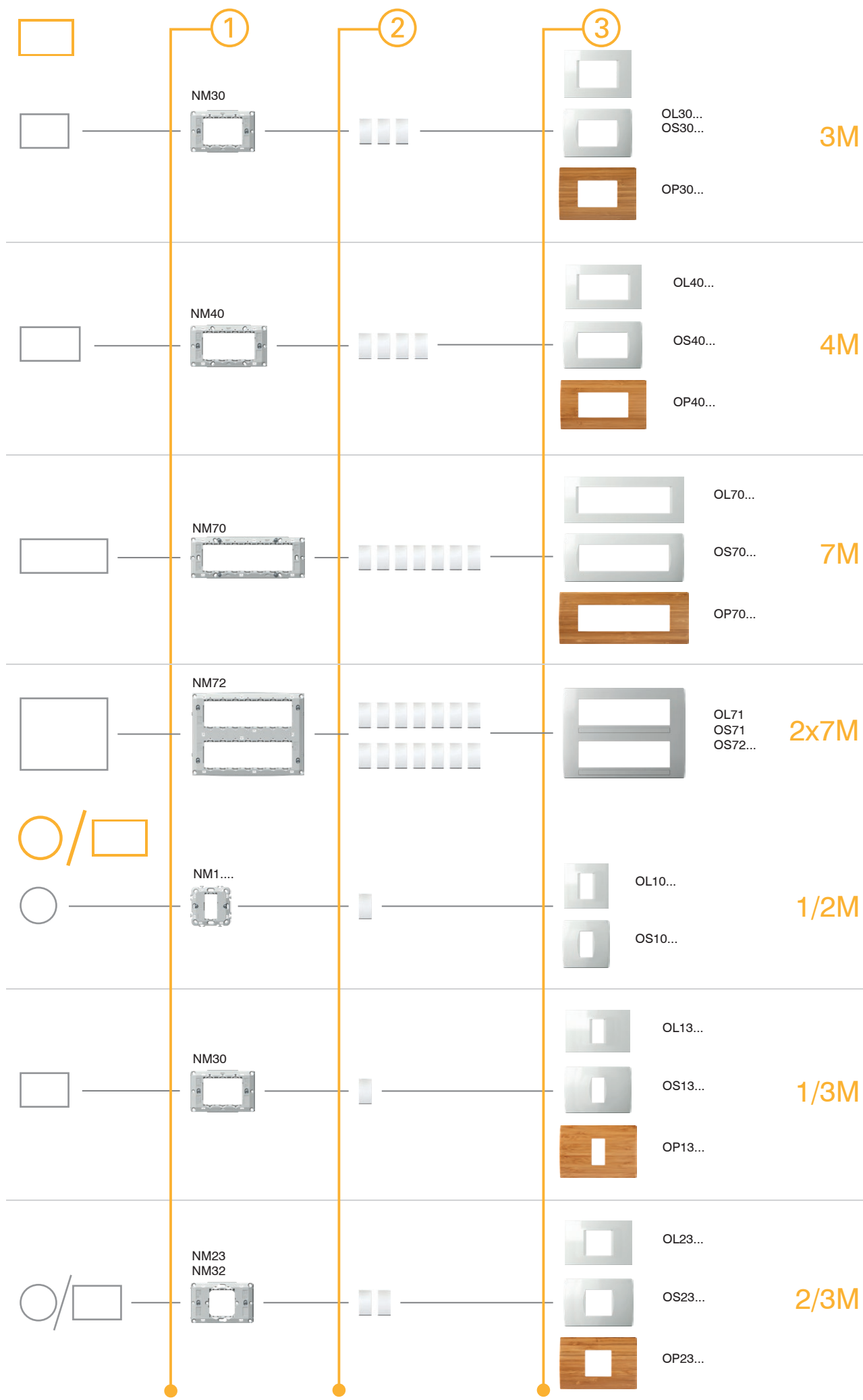

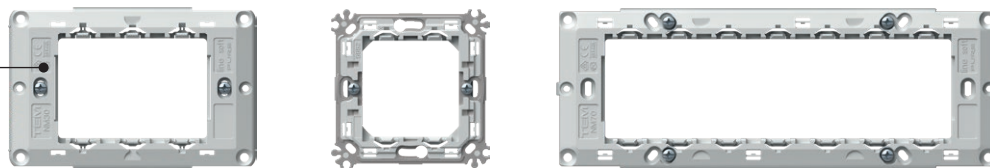

NM30

Iloji type	përshkrimi description	madhësia size
NM10	KORNIZË MONTIMI ME KTHETRA MOUNTING FRAME WITH CLAWS	1/2M
NM11	KORNIZË MONTIMI PA VIDA MOUNTING FRAME WITHOUT SCREWS	1/2M
NM20	KORNIZË MONTIMI ME KTHETRA MOUNTING FRAME WITH CLAWS	2M
...



KORNIZË MONTIMI ME KTHETRA 2M

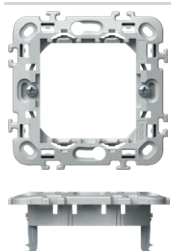

NM20

- kornizë montimi 2M me kthetra
- për montimin në kutitë Ø60 (DE..) me kthetra
- kombinime të mundshme horizontale ose vertikale 2x2M, 3x2M dhe 4x2M
- i përshatshëm për montimin me kapakët mbulues LINE dhe SOFT
- në përputhje me EN 60669-1

MOUNTING FRAME WITH CLAWS 2M

- mounting frame 2M with claws
- for mounting on boxes Ø60 (DE..) with claws
- possible horizontal or vertical combinations 2x2M, 3x2M and 4x2M
- suitable for assembling with cover plates LINE and SOFT
- in accordance with EN 60669-1

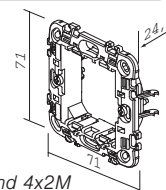

KORNIZË MONTIMI PA VIDA 2M

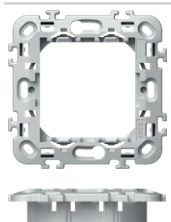

NM21

- kornizë montimi 2M pa vida dhe pa kthetra
- për montimin në kutitë Ø60 (HE..., DE..) me vida
- kombinime të mundshme horizontale ose vertikale 2x2M, 3x2M dhe 4x2M
- i përshatshëm për montimin me kapakët mbulues LINE dhe SOFT
- në përputhje me EN 60669-1

MOUNTING FRAME WITHOUT SCREWS 2M

- mounting frame 2M without screws and without claws
- for mounting on boxes Ø60 (HE..., BE..) with screws
- possible horizontal or vertical combinations 2x2M, 3x2M and 4x2M
- suitable for assembling with cover plates LINE and SOFT
- in accordance with EN 60669-1

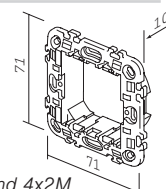

KORNIZË MONTIMI METALIKE ME KTHETRA 2M

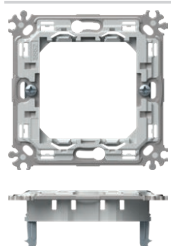

NM24

- kornizë montimi metalike 2M me kthetra - versioni i fortë
- për montimin në kutitë Ø60 (DE..) me kthetra
- kombinime të mundshme horizontale ose vertikale 2x2M, 3x2M dhe 4x2M
- i përshatshëm për montimin me kapakët mbulues PURE, LINE dhe SOFT
- në përputhje me EN 60669-1

MOUNTING FRAME METAL WITH CLAWS 2M

- metal mounting frame 2M with claws - stiff version
- for mounting on boxes Ø60 (DE..) with claws
- possible horizontal or vertical combinations 2x2M, 3x2M and 4x2M
- suitable for assembling with cover plates PURE, LINE and SOFT
- in accordance with EN 60669-1

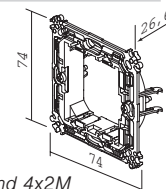

KORNIZË MONTIMI METALIKE PA VIDA 2M

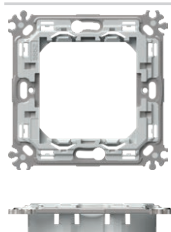

NM25

- kornizë montimi metalike me vida dhe pa kthetra - versioni i fortë
- për montimin në kutitë Ø60 (HE... BE...) me vida
- kombinime të mundshme horizontale ose vertikale 2x2M, 3x2M dhe 4x2M
- i përshatshëm për montimin me kapakët mbulues PURE, LINE dhe SOFT
- në përputhje me EN 60669-1

MOUNTING FRAME METAL WITHOUT SCREWS 2M

- metal mounting frame 2M without screws and without claws - stiff version
- for mounting in boxes Ø60 (HE..., BE...) with screws
- possible horizontal or vertical combinations 2x2M, 3x2M and 4x2M
- suitable for assembling with cover plates PURE, LINE and SOFT
- in accordance with EN 60669-1

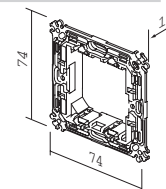

M O U N T I N G F R A M E S N M



	NM10	<p>KORNIZË MONTIMI ME KTHETRA 1/2M</p> <ul style="list-style-type: none"> - kornizë montimi 1/2M me kthetra - për montimin në kutitë Ø60 (DE..) me kthetra - i përshatshëm për montimin me kapakët mbulues LINE dhe SOFT - në përputhje me EN 60669-1 <p><i>MOUNTING FRAME WITH CLAWS 1/2M</i></p> <ul style="list-style-type: none"> - mounting frame 1/2M with claws - for mounting on boxes Ø60 (DE..) with claws - suitable for assembling with cover plates LINE and SOFT - in accordance with EN 60669-1 	
	NM11	<p>KORNIZË MONTIMI PA VIDA 1/2M</p> <ul style="list-style-type: none"> - kornizë montimi 1/2M pa vida dhe pa kthetra - për montimin në kutitë Ø60 (HE., DE..) me vida - i përshatshëm për montimin me kapakët mbulues LINE dhe SOFT - në përputhje me EN 60669-1 <p><i>MOUNTING FRAME WITHOUT SCREWS 1/2M</i></p> <ul style="list-style-type: none"> - mounting frame 1/2M without screws and without claws - for mounting on boxes Ø60 (HE., BE..) with screws - suitable for assembling with cover plates LINE and SOFT - in accordance with EN 60669-1 	
	NM23	<p>KORNIZË MONTIMI ME KTHETRA 2/3M</p> <ul style="list-style-type: none"> - kornizë montimi 2/3M me kthetra - për montimin në kutitë Ø60 (DE..) me kthetra - i përshatshëm për montimin me kapakët mbulues PURE, LINE dhe SOFT - në përputhje me EN 60669-1 <p><i>MOUNTING FRAME WITH CLAWS 2/3M</i></p> <ul style="list-style-type: none"> - mounting frame 2/3M with claws - for mounting on boxes Ø60 (DE..) with claws - suitable for assembling with cover plates PURE, LINE and SOFT - in accordance with EN 60669-1 	



NM30

KORNIZË MONTIMI ME VIDA 3M

- kornizë montimi 3M me vida
 - për montim në kutitë drejtkëndore 3M
 - i përshtatshëm për montimin me kapakët mbulues PURE, LINE dhe SOFT
 - në përputhje me EN 60669-1
- MOUNTING FRAME WITH SCREWS 3M**
- mounting frame 3M with screws
 - for mounting on rectangular boxes 3M
 - suitable for assembling with cover plates PURE, LINE and SOFT
 - in accordance with EN 60669-1

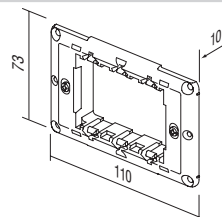

NM40

KORNIZË MONTIMI ME VIDA 4M

- kornizë montimi 4M me vida
 - për montim në kutitë drejtkëndore 4M
 - i përshtatshëm për montimin me kapakët mbulues PURE, LINE dhe SOFT
 - në përputhje me EN 60669-1
- MOUNTING FRAME WITH SCREWS 4M**
- mounting frame 4M with screws
 - for mounting on rectangular boxes 4M
 - suitable for assembling with cover plates PURE, LINE and SOFT
 - in accordance with EN 60669-1

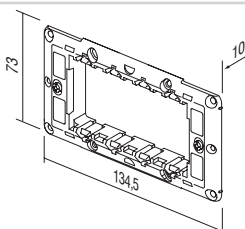

NM70

KORNIZË MONTIMI ME VIDA 7M

- kornizë montimi 7M me vida
- për montim në kutitë drejtkëndore 7M
- i përshtatshëm për montimin me kapakët mbulues PURE LINE DHE SOFT
- në përputhje me EN 60669-1

MOUNTING FRAME WITH SCREWS 7M

- mounting frame 7M with screws
- for mounting on rectangular boxes 7M
- suitable for assembling with cover plates 2x 7M
- in accordance with EN 60669-1

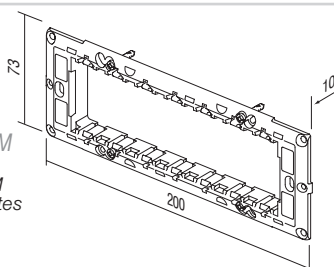

NM72

KORNIZË MONTIMI ME VIDA 2x7M

- kornizë montimi me vida 2x7M
- për montim në kutitë drejtkëndore 2x7M
- i përshtatshëm për montimin me kapak mbulues 2x7M
- në përputhje me EN 60669-1

MOUNTING FRAME WITH SCREWS 2x7M

- mounting frame 2x7M with screws
- for mounting on rectangular boxes 2x7M
- suitable for assembling with cover plates 2x 7M
- in accordance with EN 60669-1

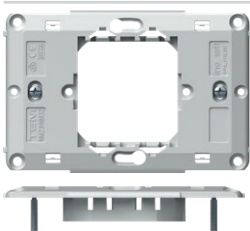
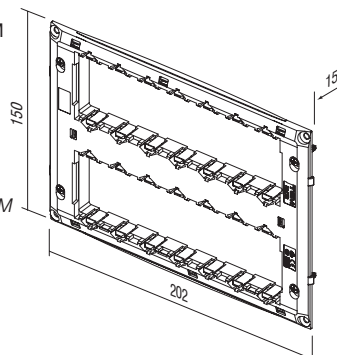

NM32

KORNIZË MONTIMI ME VIDA 2/3M

- kornizë montimi 2/3M me vida
 - për montim në kutitë drejtkëndore 3M
 - i përshtatshëm për montimin me kapakët mbulues PURE, LINE dhe SOFT
 - në përputhje me EN 60669-1
- MOUNTING FRAME WITH SCREWS 2/3M**
- mounting frame 2/3M with screws
 - for mounting on rectangular boxes 3M
 - suitable for assembling with cover plates PURE, LINE and SOFT
 - in accordance with EN 60669-1

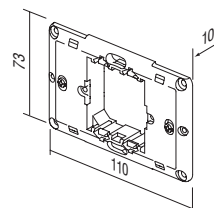



126



134



142



144





KUTITĚ

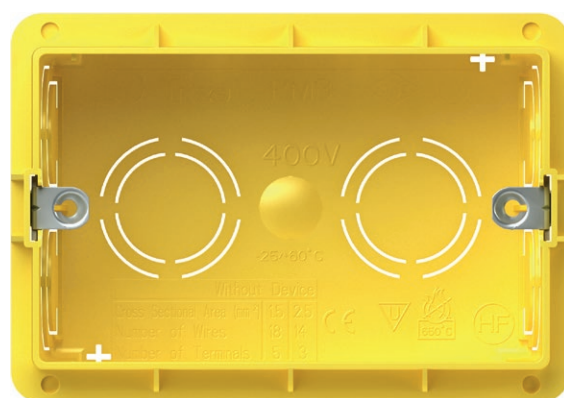

TEM

K U T I T Ë E R R U M B U L L A K Ë T A

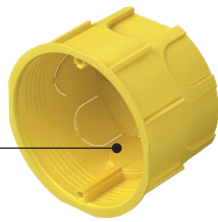

DE12



HE11



BE10

lloji type	përshkrimi description	madhësia size
DE10	KUTI E RRUMBULLAKËT TULLË ROUND BOX BRICK	SM60-01
HE10	KUTI E RRUMBULLAKËT MUR BOSH ROUND BOX HOLLOW WALL	SM68X40
BE10	KUTI E RRUMBULLAKËT BETON ROUND BOX CONCRETE	
:	:	:

KUTI E RRUMBULLAKËT TULLË SM60-01



DE10

- Ø60, thellësia 40 mm
- 650°C, 500 V~
- në përputhje me IEC 60670-1
- pa halogjenë
- opsioni i montimit të kornizës së montimit me vidë Ø 3 mm

ROUND BOX BRICK SM60-01

- Ø60, depth 40mm
- 650°C, 500V~
- in accordance with IEC 60670-1
- halogen free
- option of mounting the mounting frame with Ø 3 mm screws

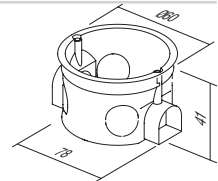

KUTI E RRUMBULLAKËT TULLË E THELLË SM60-06



DE11

- Ø60, thellësia 60mm
- 650°C, 500 V~
- në përputhje me IEC 60670-1
- pa halogjenë
- opsioni i montimit të kornizës së montimit me vidë Ø 3 mm

ROUND BOX BRICK DEEP SM60-06

- Ø60, depth 60mm
- 650°C, 500V~
- in accordance with IEC 60670-1
- halogen free
- option of mounting the mounting frame with Ø 3 mm screws

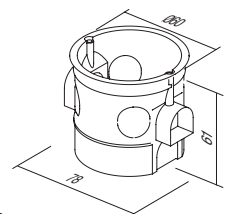

KAPËSE E KOMBINUAR SM60-03



DE30

- për montimin vertikal të kutive SM60-06 ose SM60-01
- në distancë prej 91 mm
- në përputhje me IEC 60670-1
- pa halogjenë

COMBI-CLIP SM60-03

- for vertical fitting of boxes SM60-06 or SM60-01 on distance 91 mm
- in accordance with IEC 60670-1
- halogen free

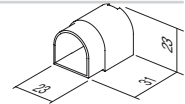

KAPËSE E KOMBINUAR SM60-04

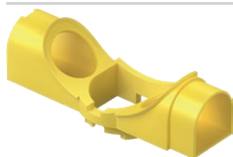

DE31

- për montimin horizontal të kutive SM60-06 ose SM60-01
- në distancë prej 71mm
- në përputhje me IEC 60670-1
- pa halogjenë

COMBI-CLIP SM60-04

- for horizontal fitting of boxes SM60-06 or SM60-01 on distance 71mm
- in accordance with IEC 60670-1
- halogen free

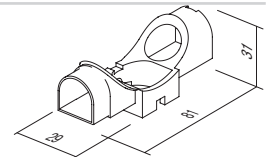

R O U N D B O X E S

	DE12	KUTI E RRUMBULLAKËT TULLË MD65-46 - Ø65, thellësia 46 mm - 650 °C, 500 V~ - në përputhje me IEC 60670-1 - pa halogjenë - opsioni i montimit të kornizës së montimit me vidë Ø 3 mm	
		ROUND BOX BRICK MD65-46 - Ø65, depth 46mm - 650°C, 500V~ - in accordance with IEC 60670-1 - halogen free - option of mounting the mounting frame with Ø 3 mm screws	
	DE13	KUTI E RRUMBULLAKËT TULLË E THELLË MD65-60 - Ø65/60, thellësia 62 mm - 650 °C, 500 V~ - në përputhje me IEC 60670-1 - pa halogjenë - opsioni i montimit të kornizës së montimit me vidë Ø 3 mm	
		ROUND BOX BRICK DEEP MD65-60 - Ø65/60, depth 62mm - 650°C, 500V~ - in accordance with IEC 60670-1 - halogen free - option of mounting the mounting frame with Ø 3 mm screws	
	DE14	PJESË SHITESË PËR MD65-46 - Ø65/60, thellësia 17mm - 650 °C, 500 V~ - në përputhje me IEC 60670-1 - pa halogjenë	
		ADDITIONAL PIECE FOR MD65-46 - Ø65/60, depth 17mm - 650°C, 500V~ - in accordance with IEC 60670-1 - halogen free	
	DE32	KAPËSE E KOMBINUAR MD65-71 - për montimin e kutive MD65 në distancë prej 71 mm - në përputhje me IEC 60670-1 - pa halogjenë	
		COMBI-CLIP MD65-71 - for fitting of boxes MD65 on distance 71mm - in accordance with IEC 60670-1 - halogen free	
	DE33	KAPËSE E KOMBINUAR MD65-91 - për montimin e kutive MD65 në distancë prej 91mm - në përputhje me IEC 60670-1 - pa halogjenë	
		COMBI-CLIP MD65-91 - for fitting of boxes MD65 on distance 91mm - in accordance with IEC 60670-1 - halogen free	
	DE20	KAPAK MBROJTËS PËR KUTI 60 - kapak mbrojtës për kuti Ø60 për DE10, DE11, DE13, DE14 - në përputhje me IEC 60670-1 - mbrojtje për kuti gjatë suvatimit	
		BOX COVER PROTECTIVE 60 - protective cover for box Ø60 for DE10, DE11, DE13, DE14 - in accordance with IEC 60670-1 - box protection during plastering	
	DE21	KAPAK MBROJTËS PËR KUTI 65 - kapak mbrojtës për kuti Ø65 për DE12 - në përputhje me IEC 60670-1 - mbrojtje për kuti gjatë suvatimit	
		BOX COVER PROTECTIVE 65 - protective cover for box Ø65 for DE12 - in accordance with IEC 60670-1 - box protection during plastering	
	DE22	KAPAK DEKORATIV PËR KUTI SM60 - kapak dekorativ për kuti Ø60 - në përputhje me IEC 60670-1 - pa halogjenë	
		BOX COVER DECORATIVE SM60 - decorative cover for boxes Ø60 - in accordance with IEC 60670-1 - halogen free	

K U T I T Ë E R R U M B U L L A K Ë T A



udhëzime për montimin /
assembly instructions

distanca mes kutive /
distance between boxes: 71mm

distanca mes kutive /
distance between boxes: 91mm

DE10,11

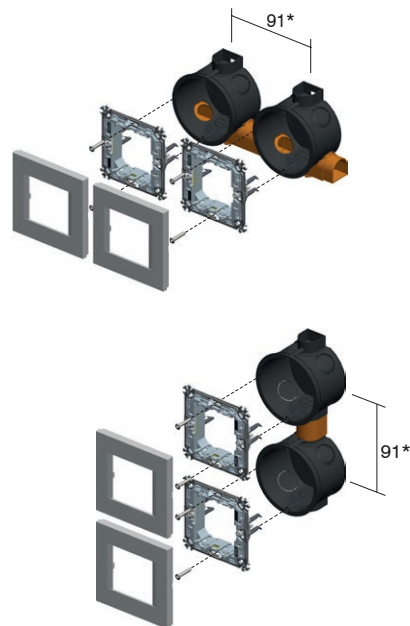
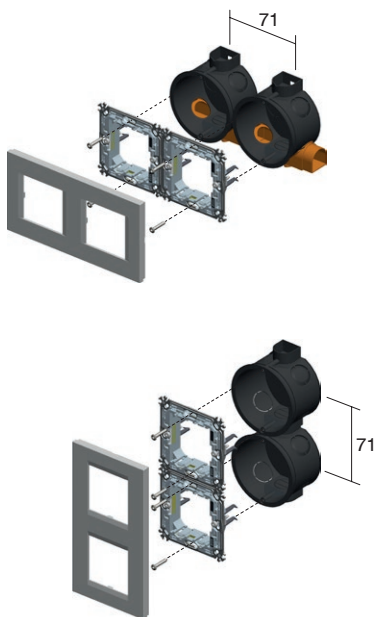
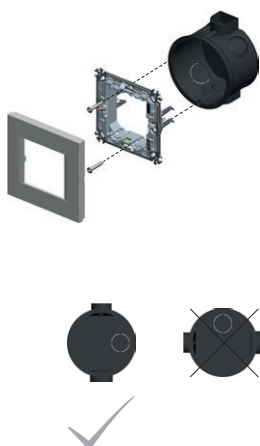

DE12,13

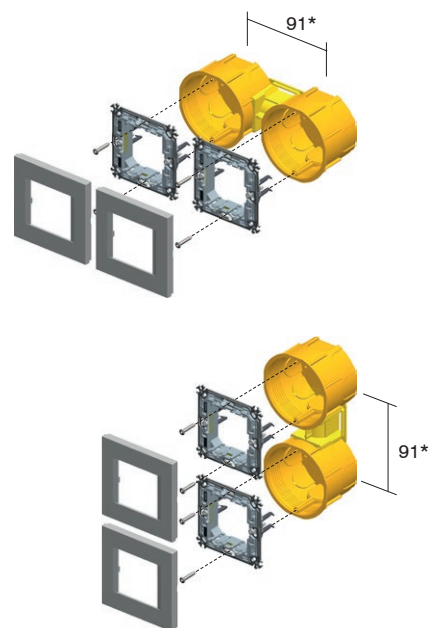
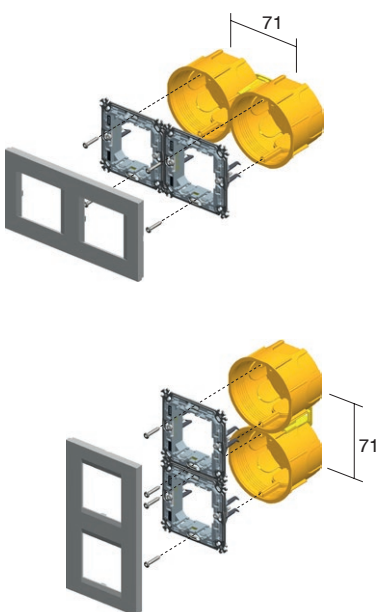
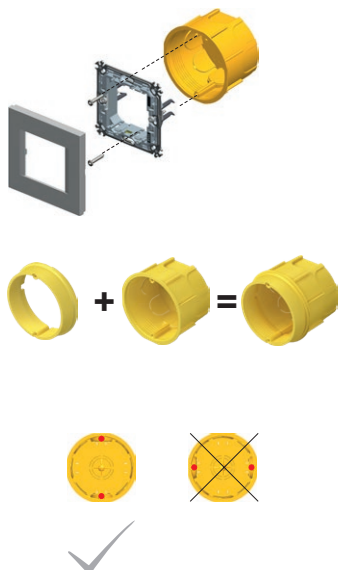

* për kapakët mbulues PURE distanca minimale mes kutive është 100 mm
* for PURE cover plates the minimum distance between boxes is 100mm

R O U N D B O X E S



DE10,11



DE12,13



NM20



NM24



DE10,11



DE12,13



NM10



DE10,11



DE12,13



NM23



71

2xDE10,11 + 2xDE31



2xNM20



2xDE12,13 + 1xDE32



2xNM24



2xDE10,11 2xDE12,13 + 1xDE32



2xNM20



2xNM24



3xDE10,11 + 3xDE31



3xNM20



3xDE12,13 + 2xDE32



3xNM24

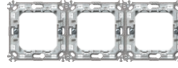

3xDE10,11 3xDE12,13 + 2xDE32

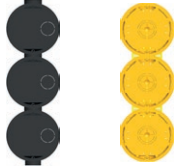

3xNM20



3xNM24



4xDE10,11 + 4xDE31



4xNM20



4xDE12,13 + 3xDE32



4xNM24



4xDE10,11 4xDE12,13 + 3xDE32

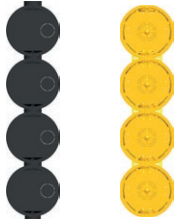

4xNM20



4xNM24



5xDE10,11

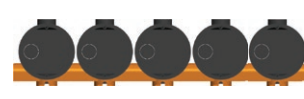

5xNM20



5xDE12,13 + 4xDE32



5xNM24

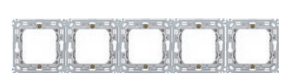

KUTI E RRUMBULLAKËT MUR BOSH SM68x40



HE10

- Ø60, thellësia 40 mm
- vrima e prerjes Ø68
- 850°C, 400V~
- në përputhje me IEC 60670-1
- montim me kthetra
- pa halogjenë
- montimi i kornizës së montimit me vidë Ø 3 mm

ROUND BOX HOLLOW WALL SM68x40

- Ø60, depth 40mm
- cutting hole Ø68
- 850°C, 400V~
- in accordance with IEC 60670-1
- mounting with claws
- halogen free
- mounting the mounting frame with Ø 3 mm screws

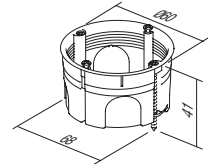

KUTI E RRUMBULLAKËT MUR BOSH SM68x55



HE11

- Ø60, thellësia 55mm
- vrima e prerjes Ø68
- 850°C, 400V~
- në përputhje me IEC 60670-1
- montim me kthetra
- pa halogjenë
- montimi i kornizës së montimit me vidë Ø 3 mm

ROUND BOX HOLLOW WALL SM68x55

- Ø60, depth 55mm
- cutting hole Ø68
- 850°C, 400V~
- in accordance with IEC 60670-1
- mounting with claws
- halogen free
- mounting the mounting frame with Ø 3 mm screws

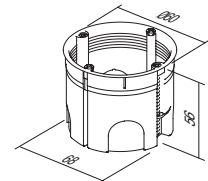

KUTI E RRUMBULLAKËT BETON



BE10

- Ø60, thellësia 49mm
- 650°C, 500 V~
- në përputhje me IEC 60670-1
- pa halogjenë
- montimi i kornizës së montimit me vidë Ø 3 mm

ROUND BOX CONCRETE

- Ø60mm, depth 49mm
- 650°C, 500V~
- in accordance with IEC 60670-1
- halogen free
- mounting the mounting frame with Ø 3 mm screws

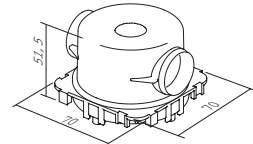

KUTI E RRUMBULLAKËT BETON E THELLË



BE11

- Ø60, thellësia 58mm
- 650°C, 500 V~
- në përputhje me IEC 60670-1
- pa halogjenë
- montimi i kornizës së montimit me vidë Ø 3 mm

ROUND BOX CONCRETE DEEP

- Ø60mm, depth 58mm
- 650°C, 500V~
- in accordance with IEC 60670-1
- halogen free
- mounting the mounting frame with Ø 3 mm screws

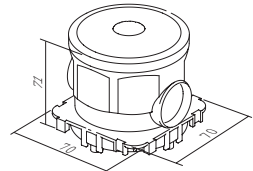

KUNDËR-SUPORT KUTIE PËR BETON



BE20

- për suportin e kutive për beton me profil në distancë BM82 muri përballë
- në përputhje me IEC 60670-1
- pa halogjenë

COUNTER BOX SUPPORT CONCRETE

- to support concrete boxes with discance profile BM82 for extreme loads
- in accordance with IEC 60670-1
- halogen free

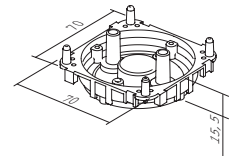

KUTI PËR BETON PËR BLOKUES TUBI 16



BE21

- për mbajtjen e tubit të instalimit në kuti
- në përputhje me IEC 60670-1
- pa halogjenë

PIPE STOPPER CONCRETE BOX 16

- for firming installation pipe to box
- in accordance with IEC 60670-1
- halogen free

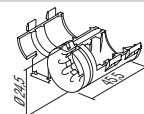

R O U N D B O X E S

mure bosh / hollow walls



beton / concrete



udhëzime për montimin /
assembly instructions

distanca mes kutive /
distance between boxes: 71mm

distanca mes kutive /
distance between boxes: 91mm

HE10,11

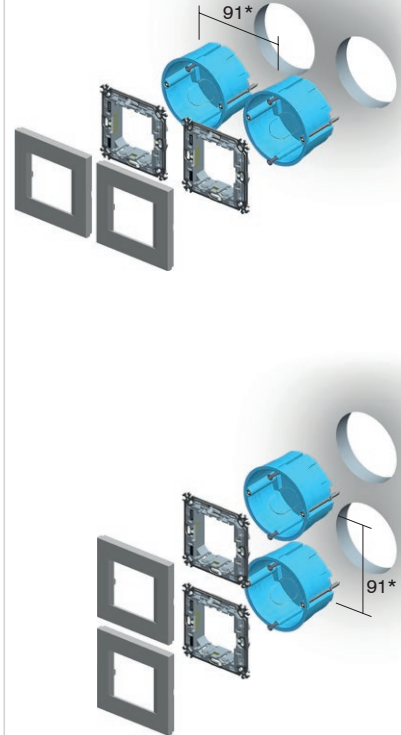
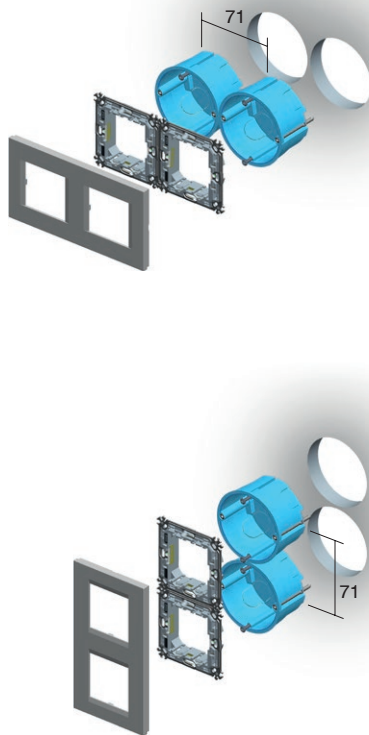
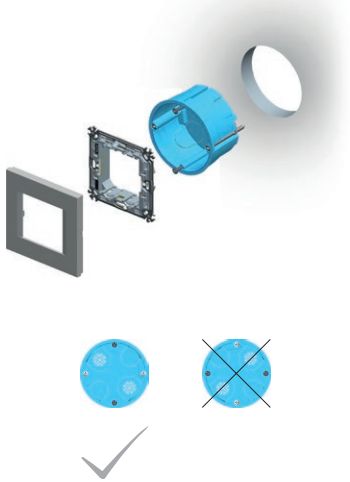

BE10

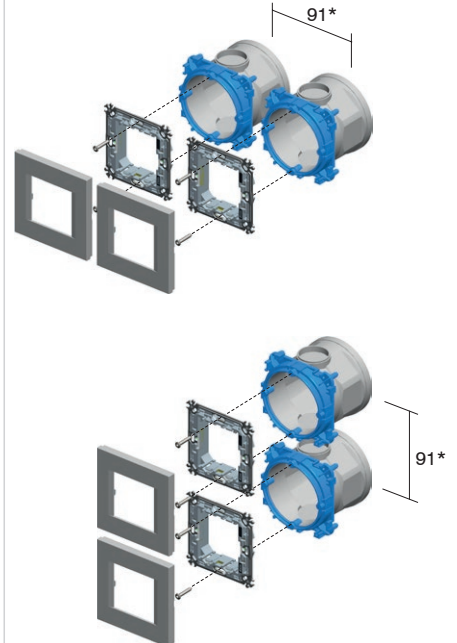
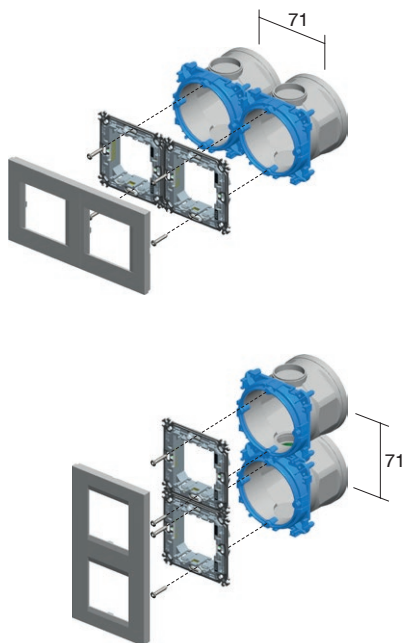
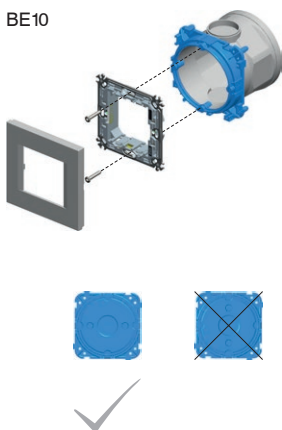

* për kapakët mbulues PURE distanca minimale mes kutive është 100 mm
* for PURE cover plates the minimum distance between boxes is 100mm

K U T I T Ě E R R U M B U L L A K Ě T A

mure bosh / hollow walls



beton / concrete



HE10,11



BE10,11



NM21



NM25



2M

HE10,11



BE10,11



NM11



1/2M

2xHE10,11



2xBE10,11



2xNM21



2xNM25



2x2M

HE10,11



BE10,11



NM32

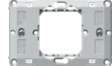

2/3M

2xHE10,11



2xBE10,11



2xNM21



2xNM25



5xHE10,11



5xNM21



5xBE10,11



5xNM25



5x2M

3xHE10,11



3xBE10,11



3xNM21



3xNM25



3x2M

3xHE10,11



3xBE10,11



3xNM21



3xNM25



4xHE10,11



4xBE10,11



4xNM21



4xNM25



4x2M

4xHE10,11



4xBE10,11



4xNM21



4xNM25



R O U N D B O X E S

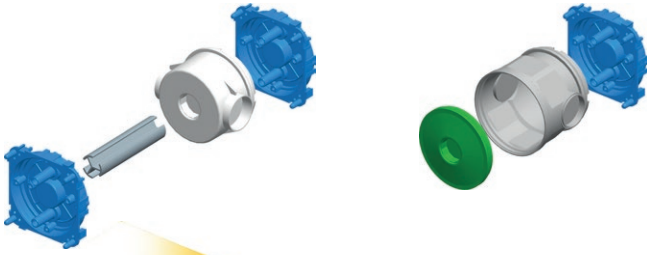

udhëzime për montimin /
assembly instructions

1

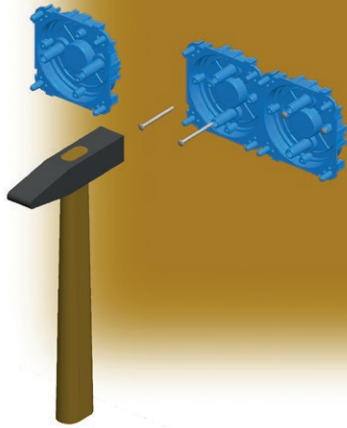

2

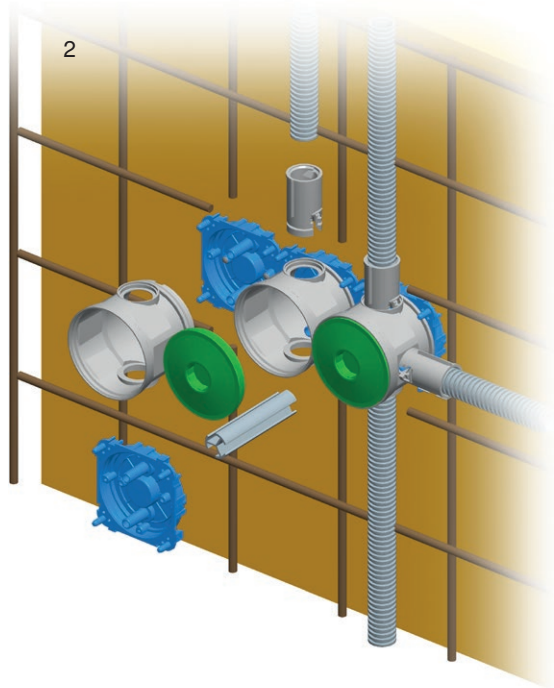

3

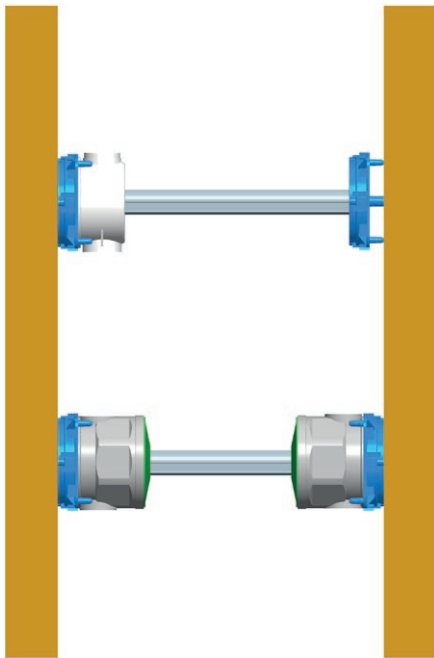

4

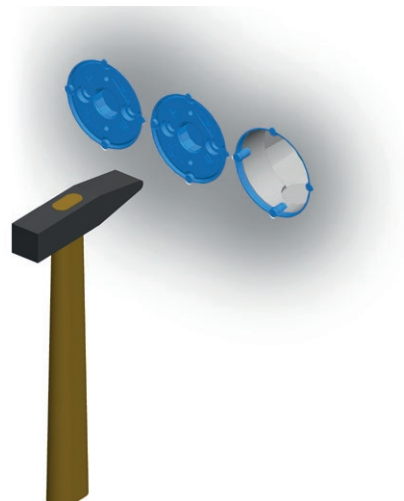



DM30



HM30



BM30

Iloji type	përshkrimi description	madhësia size
DM30	KUTI DREJTKËNDORE TULLË RECTANGULAR BOX BRICK	PM3
HM30	KUTI DREJTKËNDORE MUR BOSH RECTANGULAR BOX HOLLOW WALL	VM3
BM30	KUTI DREJTKËNDORE BETON RECTANGULAR BOX CONCRETE	BM3
·	·	·
·	·	·

KUTI DREJTKËNDORE TULLË PM3



DM30

- madhësia 3M, thellësia 49 mm
- 650°C, 400V~
- në përputhje me IEC 60670-1
- pa halogjenë

RECTANGULAR BOX BRICK PM3

- size 3M, depth 49mm
- 650°C, 400V~
- in accordance with IEC 60670-1
- halogen free

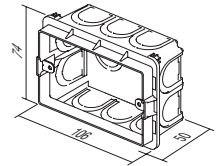

KUTI DREJTKËNDORE TULLË PM3-65



DM31

- madhësia 3M, thellësia 65mm
- 650°C, 400V~
- në përputhje me IEC 60670-1
- pa halogjenë

RECTANGULAR BOX BRICK PM3-65

- size 3M, depth 65mm
- 650°C, 400V~
- in accordance with IEC 60670-1
- halogen free

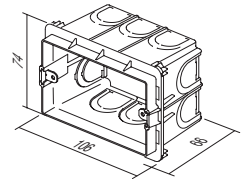

KUTI DREJTKËNDORE TULLË PM4



DM40

- madhësia 4M, thellësia 49 mm
- 650°C, 400V~
- në përputhje me IEC 60670-1
- pa halogjenë

RECTANGULAR BOX BRICK PM4

- size 4M, depth 49mm
- 650°C, 400V~
- in accordance with IEC 60670-1
- halogen free

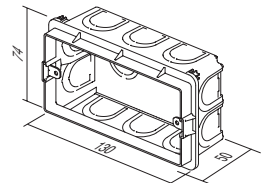

KUTI DREJTKËNDORE TULLË PM4-65



DM41

- madhësia 4M, thellësia 65mm
- 650°C, 400V~
- në përputhje me IEC 60670-1
- pa halogjenë

RECTANGULAR BOX BRICK PM4-65

- size 4M, depth 65mm
- 650°C, 400V~
- in accordance with IEC 60670-1
- halogen free

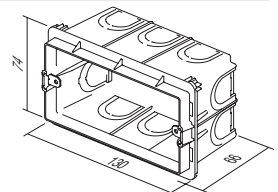

R E C T A N G U L A R B O X E S

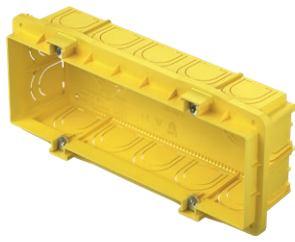

DM70

KUTI DREJTKËNDORE TULLË PM7

- madhësia 7M, thellësia 49 mm
- 650 °C, 400V~
- në përputhje me IEC 60670-1
- pa halogjenë

RECTANGULAR BOX BRICK PM7

- size 7M, depth 49mm
- 650 °C, 400V~
- in accordance with IEC 60670-1
- halogen free

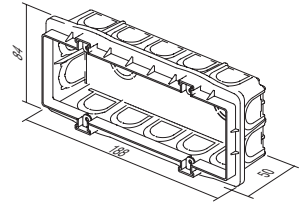

DM71

KUTI DREJTKËNDORE TULLË PM7-65

- madhësia 7M, thellësia 65mm
- 650 °C, 400V~
- në përputhje me IEC 60670-1
- pa halogjenë

RECTANGULAR BOX BRICK PM7-65

- size 7M, depth 65mm
- 650 °C, 400V~
- in accordance with IEC 60670-1
- halogen free

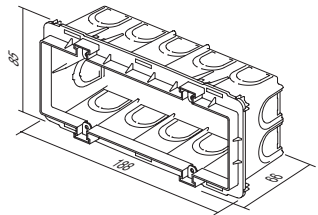

DM72

KUTI DREJTKËNDORE TULLË PM72-65

- madhësia 2x7M, thellësia 64mm
- 650 °C, 400V~
- në përputhje me IEC 60670-1
- pa halogjenë

RECTANGULAR BOX BRICK PM72-65

- size 2x7M, depth 64mm
- 650 °C, 400V~
- in accordance with IEC 60670-1
- halogen free

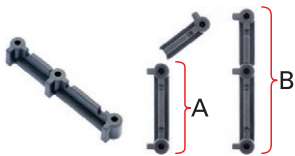
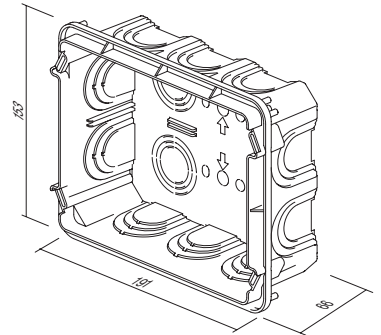

DM80

PJESË DISTANCUESE PËR KUTI PM

- për montim vertikal (A) dhe horizontal (B) të kutive PM3, PM4 në PM7
- i përshtatshëm për kapakë mbulues dekorativë Line dhe Soft (jo për PURE)

DISTANCE PIECE FOR BOX PM

- for vertical (A) and horizontal (B) fitting of boxes PM3, PM4 and PM7
- suitable for Line and Soft decorative cover plates (not for PURE)

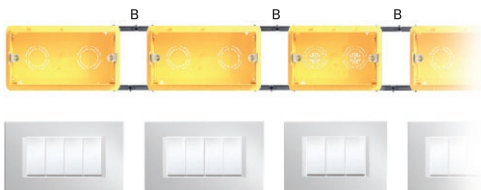
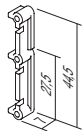



DM33

KAPAK MBROJTËS PËR KUTI PM3

- kapak mbrojtës për kuti PM3
- në përputhje me IEC 60670-1
- pa halogjenë
- mbrojtje për kuti gjatë suvatimit

BOX COVER PROTECTIVE PM3

- protective cover for box PM3
- in accordance with IEC 60670-1
- halogen free
- box protection during plastering

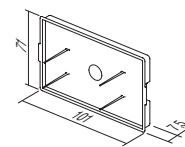

DM34

KAPAK DEKORATIV PËR KUTI PM3

- kapak dekorativ për kuti 3M
- vidat janë të përfshira
- në përputhje me IEC 60670-1
- pa halogjenë

BOX COVER DECORATIVE PM3

- decorative cover for boxes 3M
- screws are included
- in accordance with IEC 60670-1
- halogen free

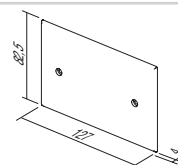

DM43

KAPAK MBROJTËS PËR KUTI PM4

- kapak mbrojtës për kuti PM4
- në përputhje me IEC 60670-1
- pa halogjenë
- mbrojtje për kuti gjatë suvatimit

BOX COVER PROTECTIVE PM4

- protective cover for box PM4
- in accordance with IEC 60670-1
- halogen free
- box protection during plastering

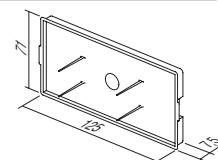

DM44

KAPAK DEKORATIV PËR KUTI PM4

- kapak dekorativ për kuti 4M
- vidat janë të përfshira
- në përputhje me IEC 60670-1
- pa halogjenë

BOX COVER DECORATIVE PM4

- decorative cover for boxes 4M
- screws are included
- in accordance with IEC 60670-1
- halogen free

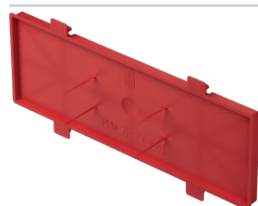
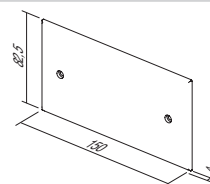

DM73

KAPAK MBROJTËS PËR KUTI PM7

- kapak mbrojtës për kuti PM7
- në përputhje me IEC 60670-1
- pa halogjenë
- mbrojtje për kuti gjatë suvatimit

BOX COVER PROTECTIVE PM7

- protective cover for box PM7
- in accordance with IEC 60670-1
- halogen free
- box protection during plastering

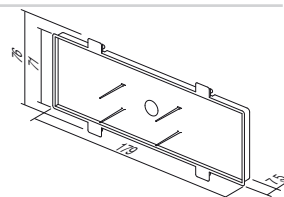

DM74

KAPAK DEKORATIV PËR KUTI PM7

- kapak dekorativ për kuti 7M
- vidat janë të përfshira
- në përputhje me IEC 60670-1
- pa halogjenë

BOX COVER DECORATIVE PM7

- decorative cover for boxes 7M
- screws are included
- in accordance with IEC 60670-1
- halogen free

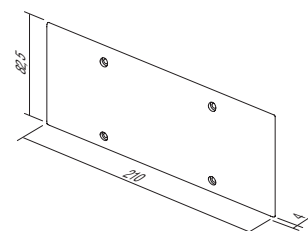

R E C T A N G U L A R B O X E S



DM75

KAPAK DEKORATIV PËR KUTI PM72

- kapak dekorativ për kuti 2x7M
- vidat janë të përfshira
- në përputhje me IEC 60670-1

BOX COVER DECORATIVE PM72

- decorative cover for boxes 2x7M
- screws are included
- in accordance with IEC 60670-1

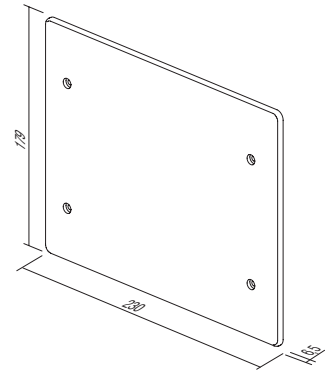

KUTI DREJTKËNDORE MUR BOSH VM3



HM30

- madhësia 3M, thellësia 49 mm
- vrima e prerjes 2xØ68/45mm
- 850°C, 400V~
- në përputhje me IEC 60670-1
- pa halogjenë

RECTANGULAR BOX HOLLOW WALL VM3

- size 3M, depth 49mm
- cutting hole 2xØ68/45mm
- 850°C, 400V~
- in accordance with IEC 60670-1
- halogen free

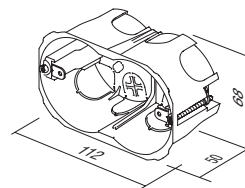

KUTI DREJTKËNDORE MUR BOSH VM4



HM40

- madhësia 4M, thellësia 49 mm
- vrima e prerjes 2xØ68/70mm
- 850°C, 400V~
- në përputhje me IEC 60670-1
- pa halogjenë

RECTANGULAR BOX HOLLOW WALL VM4

- size 4M, depth 49mm
- cutting hole 2xØ68/70mm
- 850°C, 400V~
- in accordance with IEC 60670-1
- halogen free

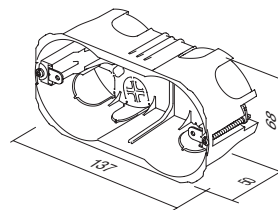

KUTI DREJTKËNDORE MUR BOSH VM7



HM70

- madhësia 7M, thellësia 49 mm
- vrima e prerjes 2xØ68/120mm
- 850°C, 400V~
- në përputhje me IEC 60670-1
- pa halogjenë

RECTANGULAR BOX HOLLOW WALL VM7

- size 7M, depth 49mm
- cutting hole 2xØ68/120mm
- 850°C, 400V~
- in accordance with IEC 60670-1
- halogen free

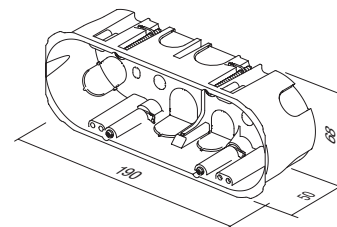

KUTI DREJTKËNDORE MUR BOSH VM72



HM72







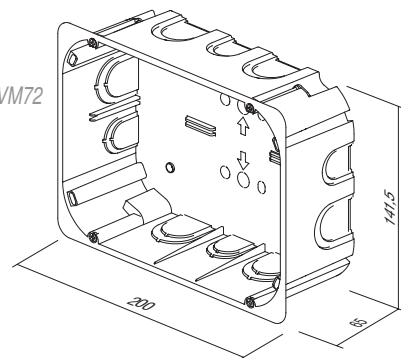

- madhësia 2x7M, thellësia 63mm
- 850°C, 400V~
- në përputhje me IEC 60670-1
- pa halogjenë

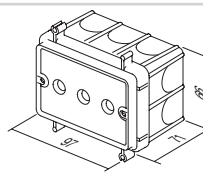
RECTANGULAR BOX HOLLOW WALL VM72

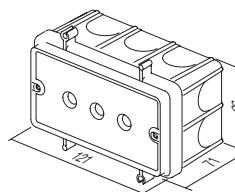
- size 2x7M, depth 63mm
- 850°C, 400V~
- in accordance with IEC 60670-1
- halogen free

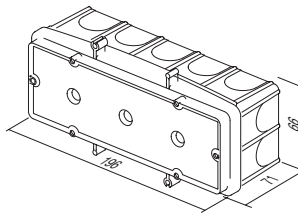

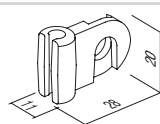
R E C T A N G U L A R B O X E S

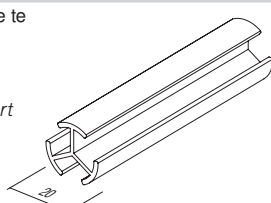
	BM30	KUTI DREJTKËNDORE BETON BM3 - madhësia 3M, thellësia 60mm - 650°C, 400V~ - në përputhje me IEC 60670-1 - pa halogjenë <i>RECTANGULAR BOX CONCRETE BM3</i> - size 3M, depth 60mm - 650°C, 400V~ - in accordance with IEC 60670-1 - halogen free	
	BM40	KUTI DREJTKËNDORE BETON BM4 - madhësia 4M, thellësia 60mm - 650°C, 400V~ - në përputhje me IEC 60670-1 - pa halogjenë <i>RECTANGULAR BOX CONCRETE BM4</i> - size 4M, depth 60mm - 650°C, 400V~ - in accordance with IEC 60670-1 - halogen free	
	BM70	KUTI DREJTKËNDORE BETON BM7 - madhësia 7M, thellësia 60mm - 650°C, 400V~ - në përputhje me IEC 60670-1 - pa halogjenë <i>RECTANGULAR BOX CONCRETE BM7</i> - size 7M, depth 60mm - 650°C, 400V~ - in accordance with IEC 60670-1 - halogen free	
	BM80	KAPËSE FIKSUESE E KOMBINUAR BM - për fiksimin e shpejtë të kutive drejtkëndore BM në shufra përforcuese - i përshtatshëm për diametër shufre deri në Ø8mm <i>FIXING COMBI-CLIP BM</i> - for fast fixation of BM rectangular boxes on reinforcing bar - suitable for bar diameter up to Ø8mm	
	BM82	PROFIL DISTANCUES PËR KUTITË PM - për suportin e kutive BM me kundër-suport kutie te muri përballë - gjatësia l=1m, diametri Ø20mm <i>DISTANCE PROFIL FOR BOXES BM</i> - to support boxes BM with counter box support on opposite wall - length l=1m, diameter Ø20mm	

K U T I T Ë D R E J T K Ë N D O R E



tullë / brick



mure bosh / hollow walls

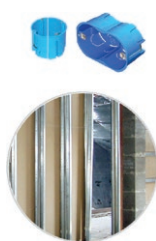

beton / concrete

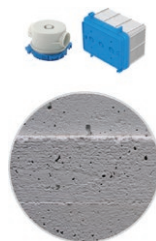

DM30     **3M**

DM40     **4M**

DM70     **7M**

DM72    **2x7M**

DM30     **2/3M**

R E C T A N G U L A R B O X E S

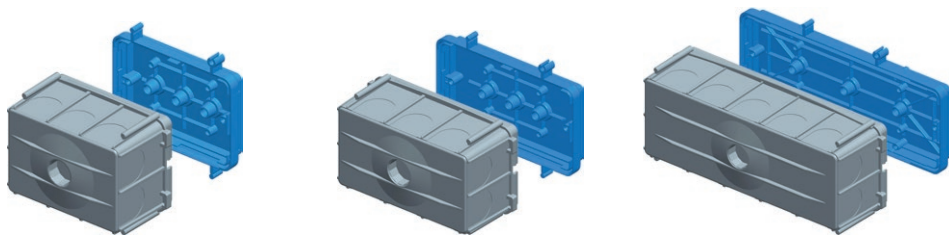

udhëzime për montimin /
assembly instructions

1

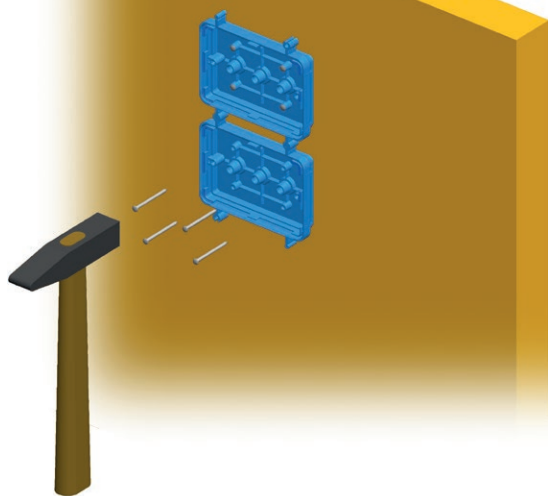

2

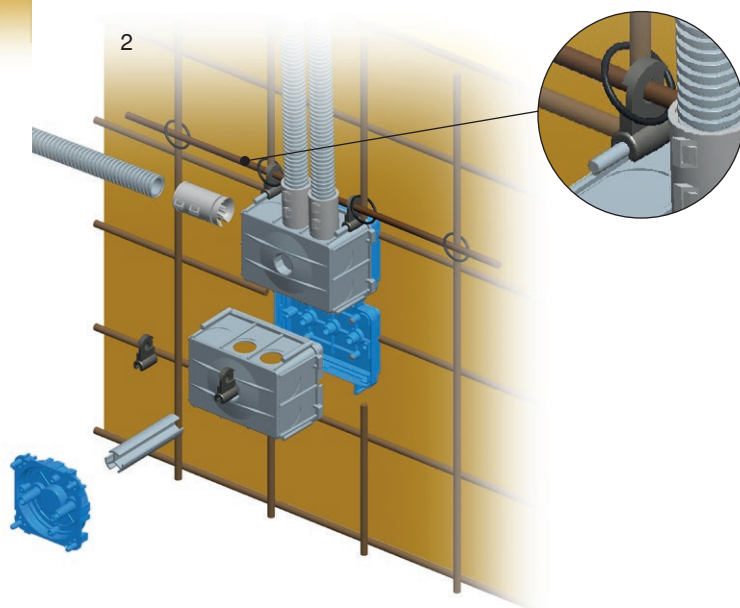

3

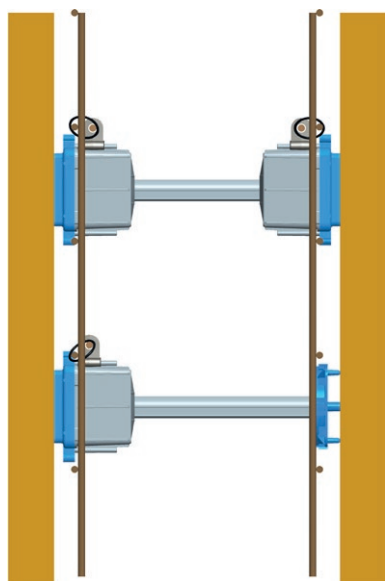

4

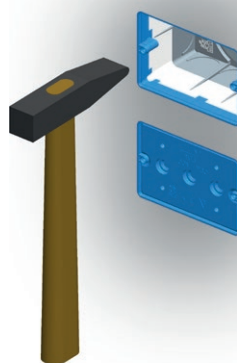

KUTI E RRUMBULLAKËT TULLË PËR LIDHJE DSM78



DW10

- Ø78, thellësia 40 mm
- 650°C, 500 V~
- në përputhje me IEC 60670-1 dhe IEC 60670-22
- pa halogjenë

CONNECTION ROUND BOX BRICK DSM78

- Ø78, depth 40mm
- 650°C, 500V~
- in accordance with IEC 60670-1 and IEC 60670-22
- halogen free

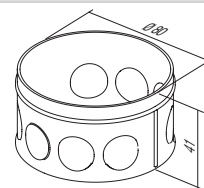

KUTI E RRUMBULLAKËT MUR BOSH SM78x45



HW10

- Ø78, thellësia 45mm
- vrima e prerjes Ø80
- 850°C, 400V~
- në përputhje me IEC 60670-1 dhe IEC 60670-22
- montim me kthetra
- pa halogjenë

CONNECTION ROUND BOX HOLLOW WALL SM78x45

- Ø78, depth 45mm
- cutting hole Ø80
- 850°C, 400V~
- in accordance with IEC 60670-1 and IEC 60670-22
- mounting with claws
- halogen free

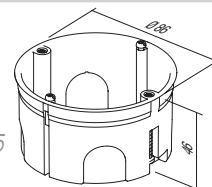

KAPAK DEKORATIV PËR KUTI SM78



DE23

- kapak dekorativ për kuti Ø78
- në përputhje me IEC 60670-1 dhe IEC 60670-22
- pa halogjenë

BOX COVER DECORATIVE SM78

- decorative cover for boxes Ø78
- in accordance with IEC 60670-1 and IEC 60670-22
- halogen free

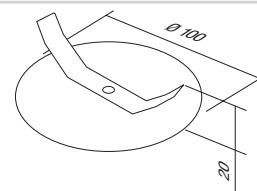

KAPAK MBROJTËS PËR KUTI 78



DE24

- kapak mbrojtës për kuti Ø78
- në përputhje me IEC 60670-1 dhe IEC 60670-22
- pa halogjenë

BOX COVER PROTECTIVE 78

- protective cover for box Ø78
- in accordance with IEC 60670-1 and IEC 60670-22
- halogen free

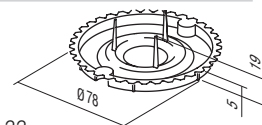

KUTI KATRORE TULLË PËR LIDHJE SM105x105



HW20

- madhësia 105X105 mm, thellësia 50 mm
- vrimë prerjeje sipas shabllonit bashkëngjitur
- 850°C, 400V~
- në përputhje me IEC 60670-1 dhe IEC 60670-22
- montim me kthetra
- pa halogjenë

CONNECTION SQUARE BOX BRICK SM105x105

- size 105x105mm, depth 50mm
- cutting hole according to attached template
- 850°C, 400V~
- in accordance with IEC 60670-1 and IEC 60670-22
- mounting with claws
- halogen free

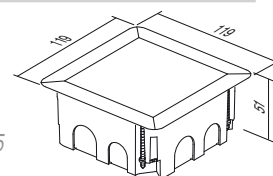

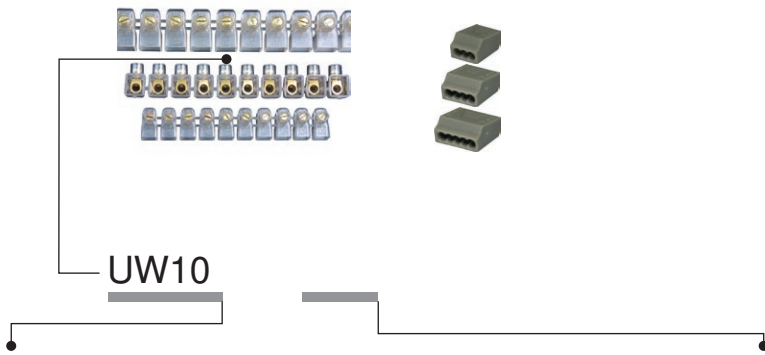

Iloji type	përshkrimi description	të dhënat teknike technical data	madhësia size	ngjyra colour
UW10	BLLOQE TERMINALES ME 1 RADHË 1 ROW TERMINAL BLOCKS	2x2.5mm ²	10P	<input checked="" type="checkbox"/> TS transparent transparent
UW11	BLLOQE TERMINALES ME 1 RADHË 1 ROW TERMINAL BLOCKS	2x4mm ²	10P	<input checked="" type="checkbox"/> CO ngjyra colour
UW12	BLLOQE TERMINALES ME 1 RADHË 1 ROW TERMINAL BLOCKS	2x6mm ²	10P	<input type="checkbox"/> WH e bardhë white
...	<input type="checkbox"/> GY gri grey

BLLOQE TERMINALES ME 1 RADHË TË MBYLLURA



- 450 V~; 2x2.5 mm² ÷ 2x6mm²
- termoplast PC, transparent
- numri i poleve: 10

1 ROW TERMINAL BLOCKS CLOSED

- 450V~; 2x2.5mm² ÷ 2x6mm²
- thermoplast PC, transparent
- number of poles: 10

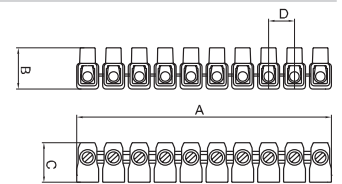

UW10TS	(NS12)	2x2.5mm ²	10P
UW11TS	(NS12)	2x4mm ²	10P
UW12TS	(NS12)	2x6mm ²	10P

	A	B	C	D
2x2.5 □	110	17.5	17.5	11
2x4 □	128	21	19	12.5
2x6 □	146	21.5	22	15

BLLOQE TERMINALES ME 1 RADHË

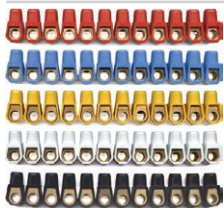

- 450 V~; 2x2.5 mm² ÷ 2x6mm²
- termoplast PA
- e disponueshme në ngjyra të ndryshme
- numri i poleve: 12

1 ROW TERMINAL BLOCKS

- 450V~; 2x2.5mm² ÷ 2x6mm²
- thermoplast PA
- available in different colours
- number of poles: 12

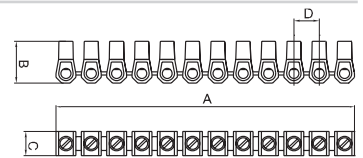

UW15CO	(NS12)	2x2.5mm ²	12P
UW16CO	(NS12)	2x4mm ²	12P
UW17CO	(NS12)	2x6mm ²	12P

	A	B	C	D
2x2.5 □	110	16.4	9	10
2x4 □	118.8	19	10	10
2x6 □	129.8	21.3	11	11.8

BLLOQE TERMINALES ME 2 RADHË PP

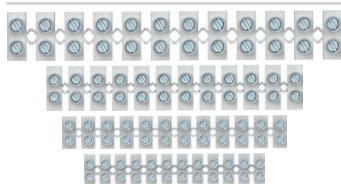

- 450 V~; 1 mm² ÷ 16 mm²
- termoplast polipropilen PP, e bardhë
- për temperaturat deri në 80°C
- numri i poleve: 12

2 ROW TERMINAL BLOCKS PP

- 450V~; 1mm² ÷ 16mm²
- thermoplast polypropylene PP, white
- for temperatures up to 80°C
- number of poles: 12

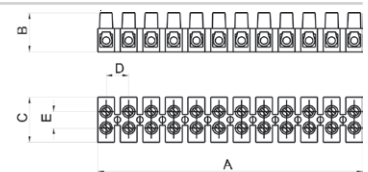

					A	B	C	D	E
UW29WHPP	1.0-4.0mm ²	24 A	450 V		94,9	13	16,6	8,1	6,4
UW30WHPP	1.5-6.0mm ²	32 A	450 V		116,5	14,9	18,9	10	7,3
UW31WHPP	2.5-10mm ²	41 A	450 V		133,8	17,3	23,4	11,5	10
UW32WHPP	4-16mm ²	76 A	450 V		174,5	20,7	25	15	11

BLOQE TERMINALES ME 2 RADHË PA

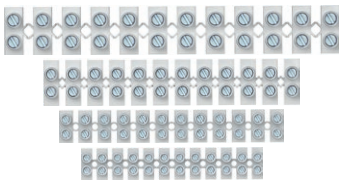

- 450 V~; 1 mm² ÷ 16 mm²
- termoplast poliamid PA, e bardhë
- për temperaturat deri në 110°C
- numri i poleve: 12

- 2 ROW TERMINAL BLOCKS PA**
- 450V~; 1mm² ÷ 16mm²
 - thermoplast polyamide PA, white
 - for temperatures up to 110°C
 - number of poles: 12

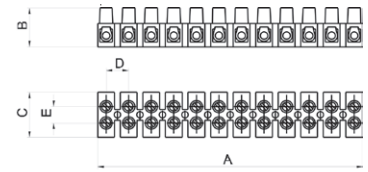

					A	B	C	D	E
UW25WHPA	1.0-4.0mm ²	24 A	450 V		93,6	13,4	16,2	8	6,4
UW26WHPA	1.5-6.0mm ²	32 A	450 V		117	15	18,6	10	7,3
UW27WHPA	2.5-10mm ²	41 A	450 V		132,8	17,3	22,2	11,5	10
UW28WHPA	4-16mm ²	76 A	450 V		173,9	20,8	25,2	15	11

KONEKTORË PËR FUTJE TELASH



- 24 A 450 V~, termoplast PA, gri
- numri i poleve: 3÷8
- kontakte për futje telash 0,5÷1,5 mm², për tela të fortë
- në përputhje me EN 60998-1

- PLUG-IN WIRE CONNECTORS**
- 24A 450V~, thermoplast PA, grey
 - number of poles: 3÷8
 - plug-in contacts 0.5÷1.5mm², for rigide wires
 - in accordance with EN 60998-1

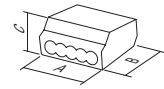

UW40GY	PC153	1.5mm ²	3P	3P	A	B	C
UW41GY	PC155	1.5mm ²	5P	5P	12	18	9
UW42GY	PC158	1.5mm ²	8P	8P	17	18	9
					26	18	9

KONEKTORË PËR FUTJE TELASH



- 24 A 450 V~, termoplast PA, gri
- numri i poleve: 3÷5
- kontakte për futje telash 1,5÷2,5mm², për tela të fortë
- në përputhje me EN 60998-1

- PLUG-IN WIRE CONNECTORS**
- 24A 450V~, thermoplast PA, grey
 - number of poles: 3÷5
 - plug-in contacts 1.5÷2.5mm², for rigide wires
 - in accordance with EN 60998-1

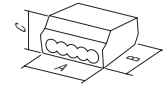

UW45GY	PC253	2.5mm ²	3P	3P	A	B	C
UW46GY	PC254	2.5mm ²	4P	4P	14	19	9
UW47GY	PC255	2.5mm ²	5P	5P	17	19	9
					21	19	9

KONEKTOR PËR FUTJE TELASH



- 24 A 450 V~, termoplast PA, gri
- numri i poleve: 2 (tel i fortë)+1 (tel i butë)
- kontakte për futje telash 1,5÷2,5mm²
- në përputhje me EN 60998-1

- PLUG-IN WIRE CONNECTOR**
- 24A 450V~, thermoplast PA, grey
 - number of poles: 2 (rigide wire)+1 (soft wire)
 - plug-in contacts 1.5÷2.5mm²
 - in accordance with EN 60998-1

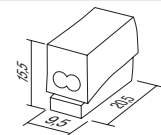

UW50WH	PC302	2.5mm ²	2/P				
--------	-------	--------------------	-----	--	--	--	--



MODUL
PURE

148

149

151

156

SHPËRNDARJA



TEM



K U T I C U B O I P 2 0 A C

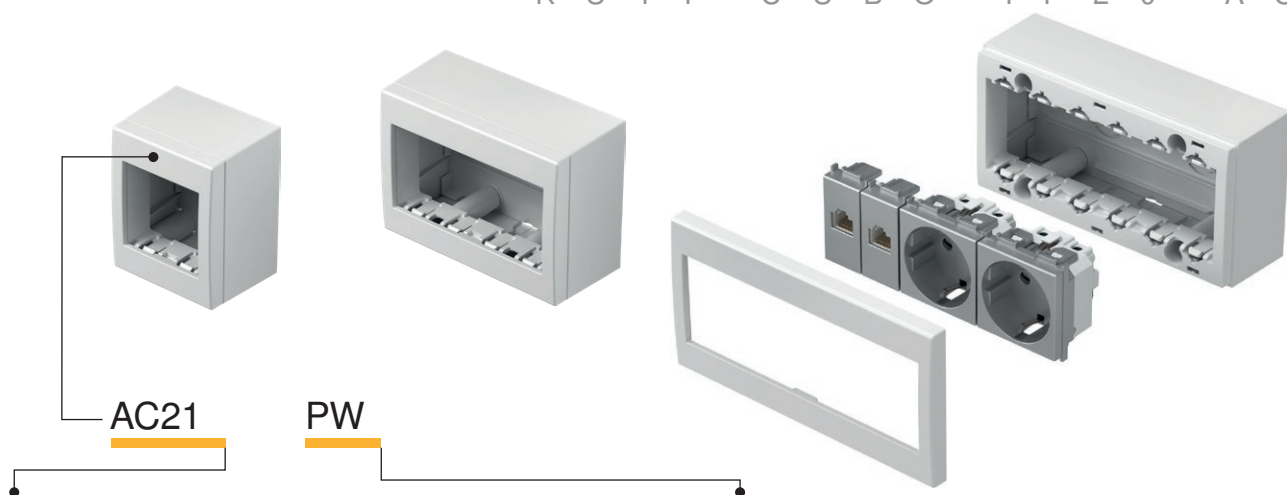

Iloji type	përshkrimi description	të dhënat teknike technical data	madhësia size	ngjyra colour
AC11	KUTI PËR MONTIM NË SIPËRFAQE NO CUBO ME KAPAK TË PASMË ANËSOR SURFACE MOUNT BOX WITH BACK SIDE COVER	IP20	1M	<input type="checkbox"/> PW e bardhë polare polar white <input type="checkbox"/> ES e argjendtë elox elox silver
AC21	KUTI PËR MONTIM NË SIPËRFAQE NO CUBO ME KAPAK TË PASMË ANËSOR SURFACE MOUNT BOX WITH BACK SIDE COVER	IP20	2M	<input type="checkbox"/> IW e bardhë fildishi ivory white
AC41	KUTI PËR MONTIM NË SIPËRFAQE NO CUBO ME KAPAK TË PASMË ANËSOR SURFACE MOUNT BOX WITH BACK SIDE COVER	IP20	4M	

KUTI NO CUBO ME KAPAK TË PASMË ANËSOR IP20 1M



- AC11PW
- AC11ES
- AC11IW

- kuti IP20 1M
- për montimin në sipërfaqe të elementeve
- e përshtatshme për çelësat SM
- në përputhje me EN 60669-1

BOX NO CUBO WITH BACK SIDE COVER IP20 1M
- box IP20 1M
- for surface mounting of elements
- suitable to SM switches
- in accordance with EN 60669-1



KUTI NO CUBO ME KAPAK TË PASMË ANËSOR IP20 2M



- AC21PW
- AC21ES
- AC21IW

- kuti IP20 2M
- për montimin në sipërfaqe të elementeve
- në përputhje me EN 60669-1, EN60884-1

BOX NO CUBO WITH BACK SIDE COVER IP20 2M
- box IP20 2M
- for surface mounting of elements
- in accordance with EN 60669-1, EN60884-1



KUTI NO CUBO ME KAPAK TË PASMË ANËSOR IP20 4M



- AC41PW
- AC41ES
- AC41IW

- kuti IP20 4M
- për montimin në sipërfaqe të elementeve
- në përputhje me EN 60669-1, EN60884-1

BOX NO CUBO WITH BACK SIDE COVER IP20 4M
- box IP20 4M
- for surface mounting of elements
- in accordance with EN 60669-1, EN60884-1



KUTI NO CUBO ME KAPAK TË PASMË ANËSOR IP20 6M



- AC61PW
- AC61ES
- AC61IW

- kuti IP20 6M
- për montimin në sipërfaqe të elementeve
- në përputhje me EN 60669-1, EN60884-1

BOX NO CUBO WITH BACK SIDE COVER IP20 6M
- box IP20 6M
- for surface mounting of elements
- in accordance with EN 60669-1, EN60884-1

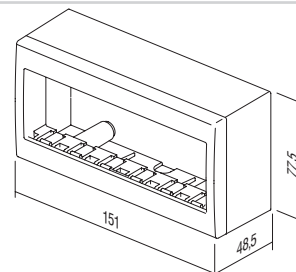
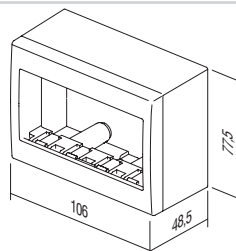
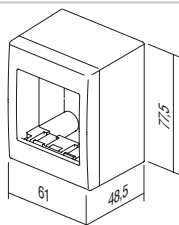
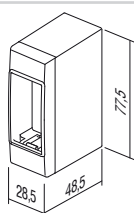

B O X E S C U B O I P 5 5 A Q



lloji type	përshkrimi description	të dhënat teknike technical data	madhësia size	ngjyra colour
AQ20	KUTI ME MONTIM NË SIPËRFAQE TË JASHTME OUTDOOR SURFACE MOUNT BOX	IP55	2M	<input type="checkbox"/> PW e bardhë polare polar white
AQ22	KUTI ME MONTIM NË SIPËRFAQE TË JASHTME OUTDOOR SURFACE MOUNT BOX	IP55	2x2M	<input checked="" type="checkbox"/> GY gri grey
AQ30	KUTI ME MONTIM NË SIPËRFAQE TË JASHTME OUTDOOR SURFACE MOUNT BOX	IP55	3M	
AQ31	KUTI ME MONTIM NË SIPËRFAQE TË JASHTME OUTDOOR SURFACE MOUNT BOX	IP55	3M	

KUTI NO CUBO IP55 2M



- AQ20PW
- AQ20GY

- kuti IP55 2M
- për montim në sipërfaqe
- IP55 për përdorim në zona me lagështirë
- në përputhje me CEI 23-48, EN 60670

BOX NO CUBO IP55 2M

- box IP55 2M
- for surface mounting
- IP55 for usage in humid areas
- in accordance with CEI 23-48, EN 60670



KUTI NO CUBO IP55 2x2M



- AQ22PW
- AQ22GY

- kuti IP55 2x2M
- për montim në sipërfaqe
- IP55 për përdorim në zona me lagështirë
- në përputhje me CEI 23-48, EN 60670

BOX NO CUBO IP55 2x2M

- box IP55 2x2M
- for surface mounting
- IP55 for usage in humid areas
- in accordance with CEI 23-48, EN 60670



KUTI NO CUBO IP55 3M



- AQ30PW
- AQ30GY

- kuti IP55 3M
- për montim në sipërfaqe
- IP55 për përdorim në zona me lagështirë
- në përputhje me CEI 23-48, EN 60670

BOX NO CUBO IP55 3M

- box IP55 3M
- for surface mounting
- IP55 for usage in humid areas
- in accordance with CEI 23-48, EN 60670





- AQ21PW
- AQ21AT

KUTI PO CUBO IP55 2M

- kuti IP55 2M
- mund të kombinohet me të gjitha elementet funksionale të Modul
- për montim rrafsh
- IP55 për përdorim në zona me lagështirë
- në përputhje me CEI 23-48, EN 60670

BOX PO CUBO IP55 2M

- box IP55 2M
- can be combined with all Modul functional elements
- for flush mounting
- IP55 for usage in humid areas
- in accordance with CEI 23-48, EN 60670



- AQ31PW
- AQ31GY

KUTI PO CUBO IP55 3M

- kuti IP55 3M
- për montim rrafsh
- IP55 për përdorim në zona me lagështirë
- në përputhje me CEI 23-48, EN 60670

BOX PO CUBO IP55 3M

- box IP55 3M
- for flush mounting
- IP55 for usage in humid areas
- in accordance with CEI 23-48, EN 60670

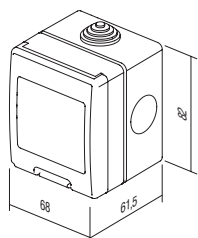

AQ20

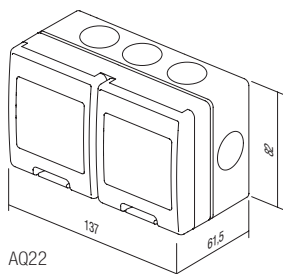

AQ22

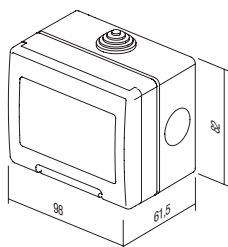

AQ30

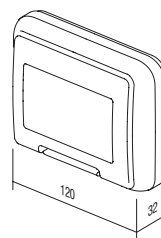

AQ31

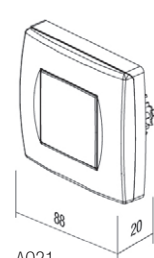

AQ21

TRUNKING SYSTEM ALUMINIUM

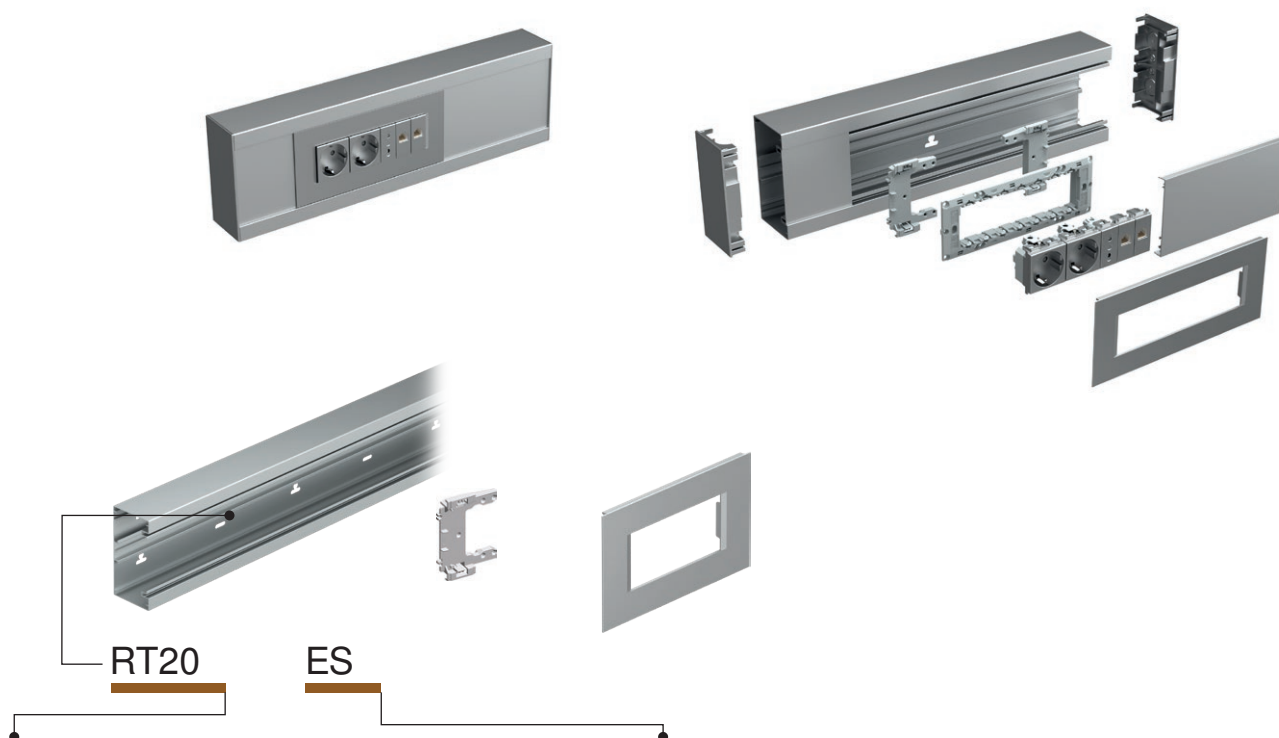

Iloji type	përshkrimi description	madhësia size	ngjyra colour
RT10	PËRSHTATËS MA 92 ADAPTER MA 92	/	■ ES e argjendtë elox elox silver-mat
RT12	KAPAK MBULUES MA 92 COVER PLATE MA 92	2/3M	□ PW e bardhë mat (RAL 9016) white-mat
RT14	KAPAK MBULUES MA 92 COVER PLATE MA 92	4M	
⋮	⋮	⋮	

PËRSHTATËS MA 92



RT10

- përshtatës për fiksimin e kornizave të montimit 2/3M, 4M ose 7M në kanalina MA pa kuti
- secila kornizë montimi ka nevojë për dy përshtatës
- në përputhje me EN 50085-1

ADAPTER MA 92

- adapter for fixing mounting frames 2/3M, 4M or 7M on MA trunking without box
- each mounting frame needs two adapters
- in accordance with EN 50085-1

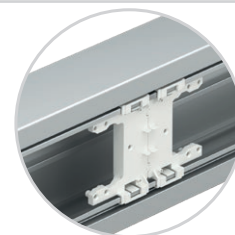

KAPAK MBULUES MA 92 2/3M



■ RT12ES
□ RT12PW

- kapak mbulues dekorativ MA 2/3M
- në përputhje me EN 50085-1

COVER PLATE MA 92 2/3M

- decorative cover plate MA 2/3M
- in accordance with EN 50085-1

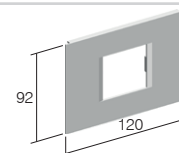

KAPAK MBULUES MA 92 4M



■ RT14ES
□ RT14PW

- kapak mbulues dekorativ MA 4M
- në përputhje me EN 50085-1

COVER PLATE MA 92 4M

- decorative cover plate MA 4M
- in accordance with EN 50085-1

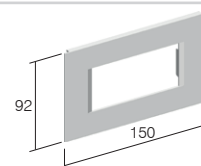

KAPAK MBULUES MA 92 7M



■ RT17ES
□ RT17PW

- kapak mbulues dekorativ MA 7M
- në përputhje me EN 50085-1

COVER PLATE MA 92 7M

- decorative cover plate MA 7M
- in accordance with EN 50085-1

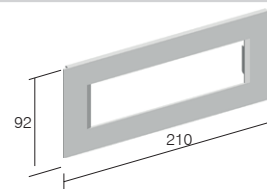

BAZË PËR KANALINA MA 130x65



- RT20ES
- RT20PW

- bazë për kanalina me profil alumini
- lartësia 130 mm, gjatësia 2 m
- DIN - formë shinë 35mm në fund
- në përputhje me EN 50085-1

TRUNKING BASE MA 130x65

- trunking base from extruded aluminium
- height 130mm, length 2m
- DIN - rail 35mm shape on bottom
- in accordance with EN 50085-1

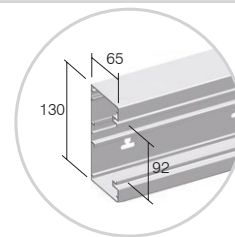

BAZË PËR KANALINA MA 165x65



- RT21ES
- RT21PW

- bazë për kanalina me profil alumini
- lartësia 165mm, gjatësia 2 m
- DIN - formë shinë 35mm në fund
- në përputhje me EN 50085-1

TRUNKING BASE MA 165x65

- trunking base from extruded aluminium
- height 165mm, length 2m
- DIN - rail 35mm shape on bottom
- in accordance with EN 50085-1

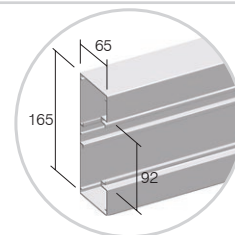

KAPAK I PËRPARMË MA 92



- RT25ES
- RT25PW

- kapak i përparmë prej profili alumini
- lartësia 92mm, gjatësia 2 m
- në përputhje me EN 50085-1

FRONT COVER MA 92

- front cover from extruded aluminium
- height 92mm, length 2m
- in accordance with EN 50085-1

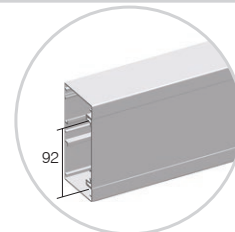

RAFT KABLLOSH MA 43



RT30

- raft kabllosh prej polimeresh
- thellësia 43mm, gjatësia 2 m
- në përputhje me EN 50085-1

CABLE SHELF MA 43

- cable shelf from extruded polymer
- depth 43mm, length 2m
- in accordance with EN 50085-1

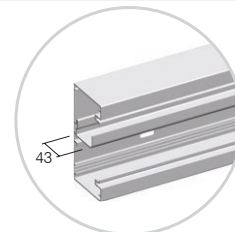

RAFT KABLLOSH MA 43 AL



RT31

- raft kabllosh prej profili alumini
- thellësia 43mm, gjatësia 2 m
- në përputhje me EN 50085-1

CABLE SHELF MA 43 AL

- cable shelf from extruded aluminium
- depth 43mm, length 2m
- in accordance with EN 50085-1

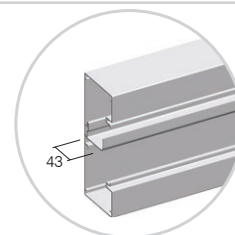

RAFT KABLLOSH MA 43 AL DYSH



RT32

- raft i dyfishtë kabllosh prej profili alumini
- thellësia 43mm, gjatësia 2 m
- në përputhje me EN 50085-1

CABLE SHELF MA 43 AL DOUBLE

- double cable shelf from extruded aluminium
- depth 43mm, length 2m
- in accordance with EN 50085-1

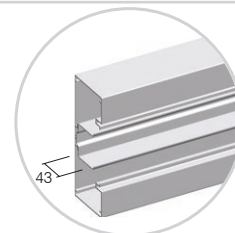

T R U N K I N G S Y S T E M A L U M I N I U M

ELEMENT FUNDOR BLOKUES MA 130x65



- RT35ES
- RT35PW

- element fundor bllokues prej polimeri
- lartësia 130mm
- në përputhje me EN 50085-1

STOP END MA 130x65

- stop end element from polymer
- height 130mm
- in accordance with EN 50085-1

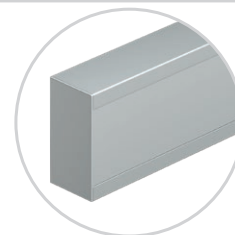

ELEMENT FUNDOR BLOKUES MA 165x65



- RT36ES
- RT36PW

- element fundor bllokues prej metali
- lartësia 165mm
- në përputhje me EN 50085-1

STOP END MA 165x65

- stop end element from metal
- height 165mm
- in accordance with EN 50085-1

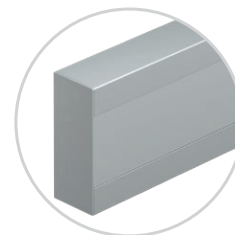

SET PJESË BASHKUESE MA 65



RT38

- pjesë bashkuese prej polimeri
- seti përmban dy pjesë dhe vida
- në përputhje me EN 50085-1

SET JOINING PIECE MA 65

- joining piece from polymer
- set contains two pieces and screws
- in accordance with EN 50085-1

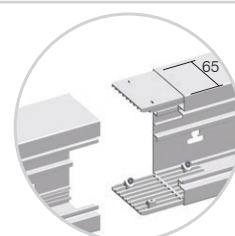

KËND UNIVERSAL MA 130x65



- RT40ES
- RT40PW

- element këndor universal
- lartësia 130mm
- në përputhje me EN 50085-1

UNIVERSAL CORNER MA 130x65

- universal corner element
- height 130mm
- in accordance with EN 50085-1

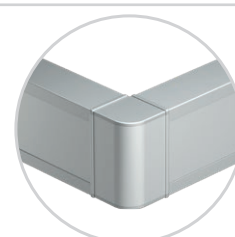

KËND UNIVERSAL MA 165x65



- RT41ES
- RT41PW

- element këndor universal
- lartësia 165mm
- në përputhje me EN 50085-1

UNIVERSAL CORNER MA 165x65

- universal corner element
- height 165mm
- in accordance with EN 50085-1

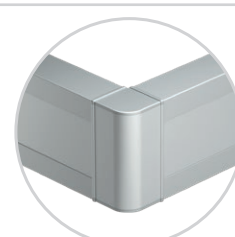

PJESË TOKËZIMI MA 2x A6.3



RT42

- pjesë tokëzimi për tokëzimin e bazës së kanalit dhe kapakut të përparmë
- në përputhje me EN 50085-1

EARTHING PIECE MA 2x A6.3

- earthing piece for earthing of trunking base and front cover
- in accordance with EN 50085-1

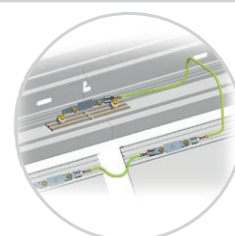

BËRRYL L MA 130x65 / 130



- RT43ES
- RT43PW

- bërryl universal L prej alumini
- lartësia 130 mm, gjatësia 400mm
- lidhje në MA 130x65
- në përputhje me EN 50085-1

L-BEND MA 130x65 / 130

- universal L bend element from aluminium
- height 130mm, length 400mm
- connection on MA 130x65
- in accordance with EN 50085-1

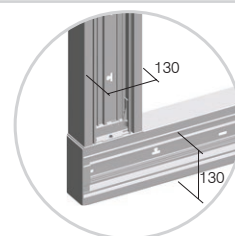

BËRRYL L MA 165x65 / 130

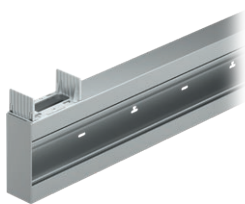

- RT44ES
- RT44PW

- bërryl universal L prej alumini
- lartësia 165mm, gjatësia 400mm
- lidhje në MA 130x65
- në përputhje me EN 50085-1

- L-BEND MA 165x65 / 130*
- universal L bend element from aluminium
 - height 165mm, length 400mm
 - connection on MA 130x65
 - in accordance with EN 50085-1

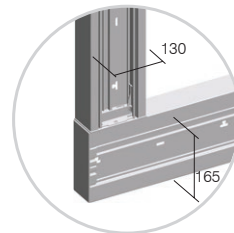

BËRRYL L MA 165x65 / 165



- RT47ES
- RT47PW

- bërryl universal L prej alumini
- lartësia 165mm, gjatësia 400mm
- lidhje në MA 165x65
- në përputhje me EN 50085-1

- L-BEND MA 165x65 / 165*
- universal L bend element from aluminium
 - height 165mm, length 400mm
 - connection on MA 165x65
 - in accordance with EN 50085-1

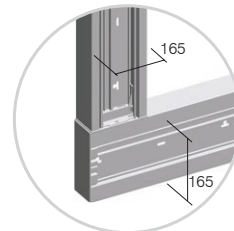

BËRRYL T MA 130x65 / 130



- RT45ES
- RT45PW

- bërryl universal T prej alumini
- lartësia 130 mm, gjatësia 400mm
- lidhje në MA 130x65
- në përputhje me EN 50085-1

- T-BEND MA 130x65 / 130*
- universal T bend element from aluminium
 - height 130mm, length 400mm
 - connection on MA 130x65
 - in accordance with EN 50085-1

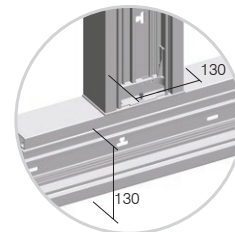

BËRRYL T MA 165x65 / 130

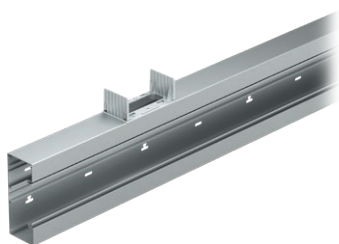

- RT46ES
- RT46PW

- bërryl universal T prej alumini
- lartësia 165mm, gjatësia 400mm
- lidhje në MA 130x65
- në përputhje me EN 50085-1

- T-BEND MA 165x65 / 130*
- universal T bend element from aluminium
 - height 165mm, length 400mm
 - connection on MA 130x65
 - in accordance with EN 50085-1

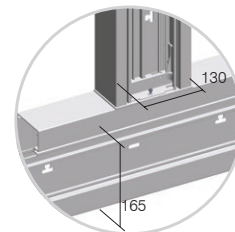

BËRRYL T MA 165x65 / 165

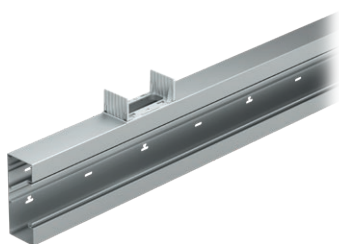

- RT48ES
- RT48PW

- bërryl universal T prej alumini
- lartësia 165mm, gjatësia 400mm
- lidhje në MA 165x65
- në përputhje me EN 50085-1

- T-BEND MA 165x65 / 165*
- universal T bend element from aluminium
 - height 165mm, length 400mm
 - connection on MA 165x65
 - in accordance with EN 50085-1

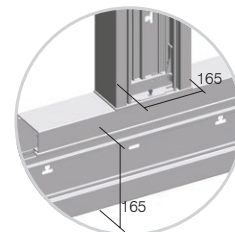

Kanalina MA bazohet në sistem modular dhe krijon kombinime elementesh 2M, 4M ose 7M

MA trunking is based on modular system making 2M, 4M or 7M combinations of elements

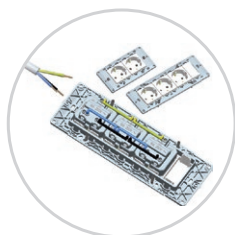

Në Modul ne ofrojmë elemente speciale për instalim të shpejtë

In Modul we provide special elements for quick installation

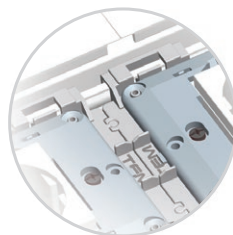

Me Përshtatësin MA ofrohet pozicionimi ekzakt pa përpjekje shtesë

With Adapter MA exact positioning without extra effort is provided

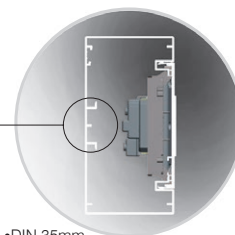

•DIN 35mm

Montimi pa kuti nënkupton më shumë hapësirë për kabllo, forma e bazës me shinë DIN EN-60715

Mounted without box means more space for cables, DIN-rail base shape EN-60715

T R U N K I N G S Y S T E M A L U M I N I U M



PLLAKËZ FIKSUESE MA NJËSHE 130x65



- RT50ES
- RT50PW

- pllakë fiksuese për fiksimin e bazës së kanalit MA130 në dysheme dhe/ose në tavan
- në përputhje me EN 50085-1

FIXING PLATE MA SINGLE 130x65

- fixing plate for fixing trunking base MA130 on the floor and/or on the ceiling
- in accordance with EN 50085-1



- RT51ES
- RT51PW

PLLAKËZ FIKSUESE MA DYSHE 130x65

- pllakëz fiksuese për fiksimin e dy bazave të kanalit MA130 në dysheme dhe/ose në tavan
- në përputhje me EN 50085-1

FIXING PLATE MA DOUBLE 130x65

- fixing plate for fixing two trunking bases MA130 on the floor and/or on the ceiling
- in accordance with EN 50085-1



- RT52ES
- RT52PW

KABINË SHËRBIMI MA 130x65x500

- kabinetë shërbimi MA
- lartësia 500mm
- kornizë montimi 7M e përfshirë
- në përputhje me EN 50085-1

SERVICE POST MA 130x65x500

- service post MA
- height 500mm
- mounting frame 7M included
- in accordance with EN 50085-1



- RT53ES
- RT53PW

KABINË SHËRBIMI MA DYSHE 130x130x500

- kabinetë shërbimi MA dyshe
- lartësia 500mm
- korniza montimi 7M të përfshira
- në përputhje me EN 50085-1

SERVICE POST MA DOUBLE 130x130x500

- service post MA double
- height 500mm
- mounting frames 7M included
- in accordance with EN 50085-1

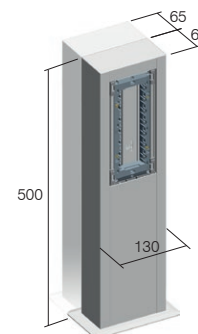

Ndërthurja e kablos / Cable intersection mm ²	Prerje e tërthortë e kablos / Cable cross-section (mm ²)				
	1 tel / 1 wire	2 tela / 2 wires	3 tela / 3 wires	4 tela / 4 wires	5 tela / 5 wires
1,5	44	111	121	144	169
2,5	49	133	157	169	211
4	58	169	183	211	256
6	68	196	225	256	307

Kanalina / Trunk	Kapaciteti i kanalit / Trunk capacity			
	MA 130x65 bosh / empty	MA 130x65 me çelësat dhe prizat Modul / with Modul switches and sockets	MA 165x65 bosh / empty	MA 130x65 me çelësat dhe prizat Modul / with Modul switches and sockets
kapaciteti capacity	7600 mm ²	5500 mm ²	9900 mm ²	7800 mm ²
max ø	54 mm	2x42 mm	54 mm	2x42 mm

K U T I D Y S H E M E J E M T

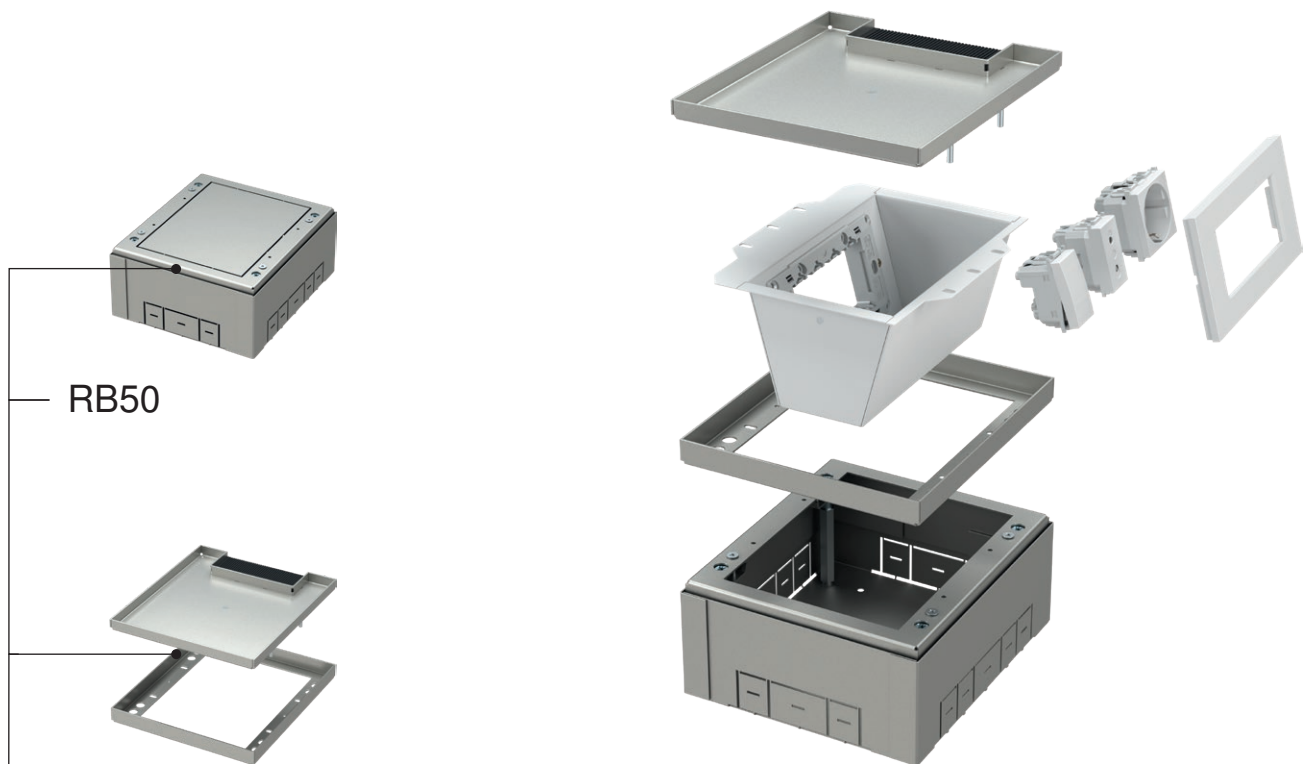

RB50

RB65S1

Iloji type	përshkrimi description	të dhënat teknike technical data
RB50	BAZË KUTIE DYSHEMEJE FLOOR BOX BASE	4M
RB65S1	INSERT PËR KUTI SHPËRNDARJEJE PËR DYSHEME FLOOR DISTRIBUTION BOX COVER	4M
RB60	INSERT PËR KUTI SHPËRNDARJEJE PËR DYSHEME INSERT FOR FLOOR DISTRIBUTION BOX	4M
·	·	·
·	·	·

	RB65S1	RB66S1	RB67S2	RB68S2
X	177	178	265	516,5
Y	200,5	265	265	265
Z	17,5	17,5	17,5	17,5

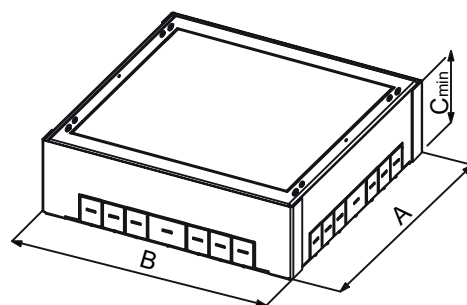
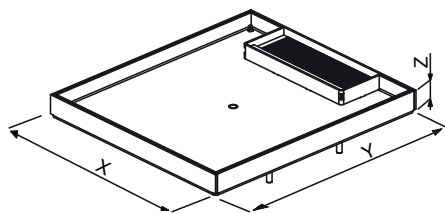

	RB50	RB51	RB52	RB53
A	208,5	273	273	273
B	182	182,5	269,5	521
C	83	83	83	83

F L O O R B O X E S M T

BAZË KUTIE DYSHEMEJE 4M



RB50

- bazë kutie dysHEMEJE 4M
- metalike, e galvanizuar
- për instalim në një dysHEME ose dysHEME dysHE
- dimensionet e montimit 208,5x182 mm, thellësia min. 83 mm
- lartësia e rregullueshme 83-128 mm
- në përputhje me standardet EN 5005-1 në EN 50085-2-2

FLOOR BOX BASE 4M

- floor box base 4M
- metal, galvanized
- for installation in a floor or double floor
- mounting dimensions 208.5x182mm, min. depth 83mm
- adjustable height 83-128mm
- In accordance with EN 5005-1 and EN 50085-2-2

INSERT PËR KUTI SHPËRNDARJEJE PËR DYSHEME 4M



RB60

- insert për kuti shpërndarjeje 4M
- metalik, ngjyrë e bardhë RAL 9006
- korniza e montimit MODUL 4M e përfshirë
- në përputhje me standardet EN 5005-1 në EN 50085-2-2

INSERT FOR FLOOR DISTRIBUTION BOX 4M

- insert for floor box 4M
- metal, colour white RAL 9006
- mounting frame MODUL 4M included
- in accordance with EN 5005-1 and EN 50085-2-2

KAPAK PËR KUTI SHPËRNDARJEJE PËR DYSHEME 4M



RB65S1

- kapak për kuti dysHEMEJE 4M
- metalik, i galvanizuar
- dimensionet e montimit 200,5x177 mm, thellësia 17,5 mm
- trashësia e dysHEMESË deri në 11,5 mm
- në përputhje me standardet EN 5005-1 në EN 50085-2-2

FLOOR DISTRIBUTION BOX COVER 4M

- floor box cover 4M
- metal, galvanized
- mounting dimensions 200.5x177mm, depth 17.5mm
- floor thickness up to 11.5mm
- in accordance with EN 5005-1 and EN 50085-2-2

BAZË KUTIE DYSHEMEJE 7M



RB51

- bazë kutie dysHEMEJE 7M
- metalike, e galvanizuar
- për instalim në një dysHEME ose dysHEME dysHE
- dimensionet e montimit 273x182,5 mm, thellësia min. 83 mm
- lartësia e rregullueshme 83-128 mm
- në përputhje me standardet EN 5005-1 në EN 50085-2-2

FLOOR BOX BASE 7M

- floor box base 7M
- metal, galvanized
- for installation in a floor or double floor
- mounting dimensions 273x182.5mm, min. depth 83mm
- adjustable height 83-128mm
- in accordance with EN 5005-1 and EN 50085-2-2

INSERT PËR KUTI SHPËRNDARJEJE PËR DYSHEME 7M



RB61

- insert për kuti dysHEMEJE 7M
- metalik, ngjyrë e bardhë RAL 9006
- korniza e montimit MODUL 7M e përfshirë
- në përputhje me standardet EN 5005-1 në EN 50085-2-2

INSERT FOR FLOOR DISTRIBUTION BOX 7M

- insert for floor box 7M
- metal, colour white RAL 9006
- mounting frame MODUL 7M included
- in accordance with EN 5005-1 and EN 50085-2-2

KAPAK PËR KUTI SHPËRNDARJEJE PËR DYSHEME 7M



RB66S1

- kapak për kuti dysHEMEJE 7M
- metalik, i galvanizuar
- dimensionet e montimit 265x178 mm, thellësia 17,5 mm
- trashësia e dysHEMESË deri në 11,5 mm
- në përputhje me standardet EN 5005-1 në EN 50085-2-2

FLOOR DISTRIBUTION BOX COVER 7M

- floor box cover 7M
- metal, galvanized
- mounting dimensions 265x178mm, depth 17.5mm
- floor thickness up to 11.5mm
- in accordance with EN 5005-1 and EN 50085-2-2

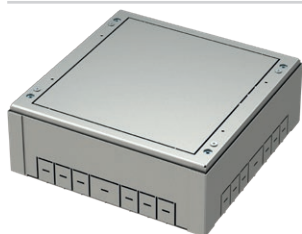

RB52

BAZË KUTIE DYSHEMEJE 2X7M

- bazë kutie dyshemeje 2X7M
- metalike, e galvanizuar
- për instalim në një dysheme ose dysheme dyshe
- dimensionet e montimit 273x269,5 mm, thellësia min. 83 mm
- lartësia e rregullueshme 83-128 mm
- në përputhje me standardet EN 5005-1 në EN 50085-2-2

FLOOR BOX BASE 2X7M

- floor box base 2X7M
- metal, galvanized
- for installation in a floor or double floor
- mounting dimensions 273x269.5mm, min. depth 83mm
- adjustable height 83-128mm
- in accordance with EN 5005-1 and EN 50085-2-2



RB62

INSERT PËR KUTI SHPËRNDARJEJE PËR DYSHEME 2X7M

- insert për kuti dyshemeje 2x7M
- metalik, ngjyrë e bardhë RAL 9006
- kornizat e montimit MODUL 2x7M të përfshira
- në përputhje me standardet EN 5005-1 në EN 50085-2-2

INSERT FOR FLOOR DISTRIBUTION BOX 2X7M

- insert for floor box 2x7M
- metal, colour white RAL 9006
- mounting frames MODUL 2x7M included
- in accordance with EN 5005-1 and EN 50085-2-2

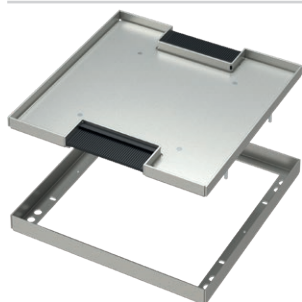

RB67S2

KAPAK PËR KUTI SHPËRNDARJEJE PËR DYSHEME 2X7M

- kapak për kuti dyshemeje 2x7M
- metalik, i galvanizuar
- dimensionet e montimit 265x265 mm, thellësia 17,5 mm
- trashësia e dyshemesë deri në 11,5 mm
- në përputhje me standardet EN 5005-1 në EN 50085-2-2

FLOOR DISTRIBUTION BOX COVER 2X7M

- floor box cover 2x7M
- metal, galvanized
- mounting dimensions 265x265mm, depth 17.5mm
- floor thickness up to 11.5mm
- in accordance with EN 5005-1 and EN 50085-2-2

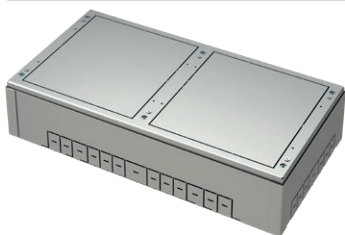

RB53

BAZË KUTIE DYSHEMEJE 4X7M

- bazë kutie dyshemeje 4X7M
- metalike, e galvanizuar
- për instalim në një dysheme ose dysheme dyshe
- dimensionet e montimit 273x521 mm, thellësia min. 83 mm
- lartësia e rregullueshme 83-128 mm
- në përputhje me standardet EN 5005-1 në EN 50085-2-2

FLOOR BOX BASE 4X7M

- floor box base 4X7M
- metal, galvanized
- for installation in a floor or double floor
- mounting dimensions 273x521mm, min. depth 83mm
- adjustable height 83-128mm
- in accordance with EN 5005-1 and EN 50085-2-2



RB62

INSERT PËR KUTI SHPËRNDARJEJE PËR DYSHEME 2X7M

- insert për kuti dyshemeje 2x7M
- metalik, ngjyrë e bardhë RAL 9006
- kornizat e montimit MODUL 2x7M të përfshira
- në përputhje me standardet EN 5005-1 në EN 50085-2-2

INSERT FOR FLOOR DISTRIBUTION BOX 2X7M

- insert for floor box 2x7M
- metal, colour white RAL 9006
- mounting frames MODUL 2x7M included
- in accordance with EN 5005-1 and EN 50085-2-2



RB68S2

KAPAK PËR KUTI SHPËRNDARJEJE PËR DYSHEME 4X7M

- kapak për kuti dyshemeje 4x7M
- metalik, i galvanizuar
- dimensionet e montimit 265x516,5 mm, thellësia 17,5 mm
- trashësia e dyshemesë deri në 11,5 mm
- në përputhje me standardet EN 5005-1 në EN 50085-2-2

FLOOR DISTRIBUTION BOX COVER 4X7M

- floor box cover 4x7M
- metal, galvanized
- mounting dimensions 265x516.5mm, depth 17.5mm
- floor thickness up to 11.5mm
- in accordance with EN 5005-1 and EN 50085-2-2

F L O O R B O X E S M T



Iloji type	përshkrimi description	të dhënat teknike technical data
RB55S1	KUTI DYSHEMEJE ME KAPAK PËR DYSHEME DYSHE FLOOR BOX WITH COVER FOR DOUBLE FLOORS	4M
RB60	INSERT PËR KUTI SHPËRNDARJEJE PËR DYSHEME INSERT FOR FLOOR DISTRIBUTION BOX	4M
⋮	⋮	⋮

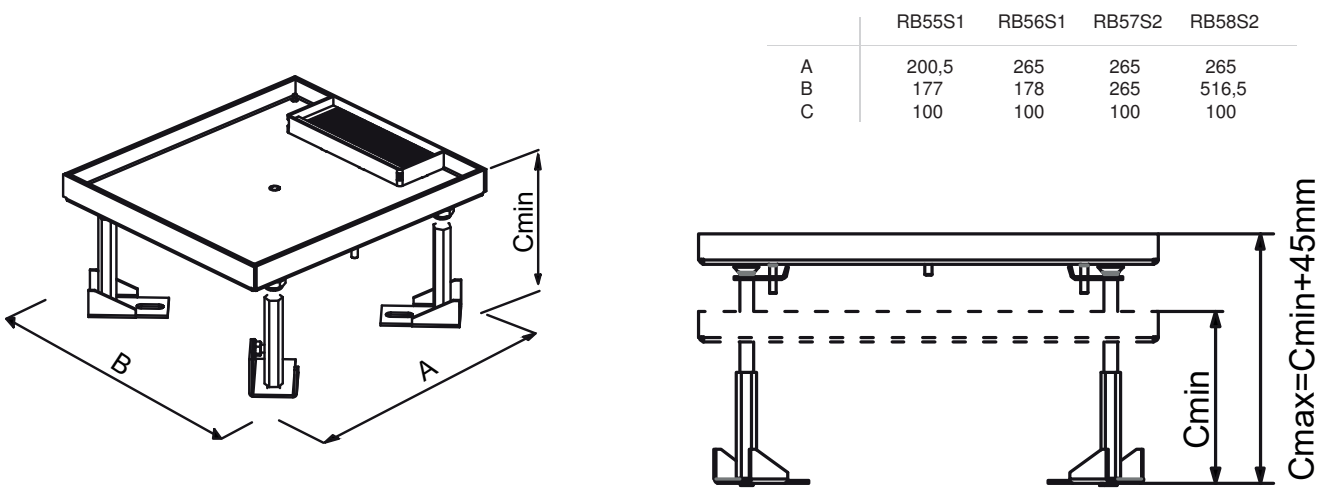



RB55S1

- bazë kutie dyshemeje 4M
- metalike, e galvanizuar
- dimensionet e montimit 200,5x177 mm, thellësia min. 100 mm
- lartësia e rregullueshme 100-145 mm
- trashësia e dyshemesë deri në 11,5 mm
- në përputhje me standardet EN 5005-1 në EN 50085-2-2

FLOOR BOX WITH COVER FOR DOUBLE FLOORS 4M

- floor box base 4M
- metal, galvanized
- mounting dimensions 200.5x177mm, min. depth 100mm
- adjustable height 100-145mm
- floor thickness up to 11.5mm
- in accordance with EN 5005-1 and EN 50085-2-2



RB60

- insert për kuti shpërndarjeje 4M
- metalik, ngjyrë e bardhë RAL 9006
- korniza e montimit MODUL 4M e përfshirë
- në përputhje me standardet EN 5005-1 në EN 50085-2-2

INSERT FOR FLOOR DISTRIBUTION BOX 4M

- insert for floor box 4M
- metal, colour white RAL 9006
- mounting frame MODUL 4M included
- in accordance with EN 5005-1 and EN 50085-2-2

KUTI DYSHEMEJE ME KAPAK PËR DYSHEME DYSHE 7M



RB56S1

- bazë kutie dyshemeje 7M
- metalike, e galvanizuar
- dimensionet e montimit 265x178 mm, thellësia min. 100 mm
- lartësia e rregullueshme 100-145 mm
- trashësia e dyshemesë deri në 11.5 mm
- në përputhje me standardet EN 5005-1 në EN 50085-2-2

FLOOR BOX WITH COVER FOR DOUBLE FLOORS 7M

- floor box base 7M
- metal, galvanized
- mounting dimensions 265x178mm, min. depth 100mm
- adjustable height 100-145mm
- floor thickness up to 11.5mm
- in accordance with EN 5005-1 and EN 50085-2-2

INSERT PËR KUTI SHPËRNDARJEJE PËR DYSHEME 7M



RB61

- insert për kuti dyshemeje 7M
- metalik, ngjyrë e bardhë RAL 9006
- korniza e montimit MODUL 7M e përfshirë
- në përputhje me standardet EN 5005-1 në EN 50085-2-2

INSERT FOR FLOOR DISTRIBUTION BOX 7M

- insert for floor box 7M
- metal, colour white RAL 9006
- mounting frame MODUL 7M included
- in accordance with EN 5005-1 and EN 50085-2-2

KUTI DYSHEMEJE ME KAPAK PËR DYSHEME DYSHE 2X7M



RB57S2

- bazë kutie dyshemeje 2x7M
- metalike, e galvanizuar
- dimensionet e montimit 265x265 mm, thellësia min. 100 mm
- lartësia e rregullueshme 100-145 mm
- trashësia e dyshemesë deri në 11.5 mm
- në përputhje me standardet EN 5005-1 në EN 50085-2-2

FLOOR BOX WITH COVER FOR DOUBLE FLOORS 2X7M

- floor box base 2x7M
- metal, galvanized
- mounting dimensions 265x265mm, min. depth 100mm
- adjustable height 100-145mm
- floor thickness up to 11.5mm
- in accordance with EN 5005-1 and EN 50085-2-2

INSERT PËR KUTI SHPËRNDARJEJE PËR DYSHEME 2X7M



RB62

- insert për kuti dyshemeje 2x7M
- metalik, ngjyrë e bardhë RAL 9006
- kornizat e montimit MODUL 2x7M të përfshira
- në përputhje me standardet EN 5005-1 në EN 50085-2-2

INSERT FOR FLOOR DISTRIBUTION BOX 2X7M

- insert for floor box 2x7M
- metal, colour white RAL 9006
- mounting frames MODUL 2x7M included
- in accordance with EN 5005-1 and EN 50085-2-2

KUTI DYSHEMEJE ME KAPAK PËR DYSHEME DYSHE 4X7M



RB58S2

- bazë kutie dyshemeje 4x7M
- metalike, e galvanizuar
- dimensionet e montimit 265x516.5 mm, thellësia min. 100 mm
- lartësia e rregullueshme 100-145 mm
- trashësia e dyshemesë deri në 11.5 mm
- në përputhje me standardet EN 5005-1 në EN 50085-2-2

FLOOR BOX WITH COVER FOR DOUBLE FLOORS 4X7M

- floor box base 4x7M
- metal, galvanized
- mounting dimensions 265x516.5mm, min. depth 100mm
- adjustable height 100-145mm
- floor thickness up to 11.5mm
- in accordance with EN 5005-1 and EN 50085-2-2

INSERT PËR KUTI SHPËRNDARJEJE PËR DYSHEME 2X7M

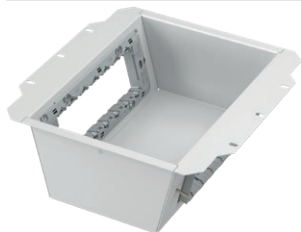

RB62

- insert për kuti dyshemeje 2x7M
- metalik, ngjyrë e bardhë RAL 9006
- kornizat e montimit MODUL 2x7M të përfshira
- në përputhje me standardet EN 5005-1 në EN 50085-2-2

INSERT FOR FLOOR DISTRIBUTION BOX 2X7M

- insert for floor box 2x7M
- metal, colour white RAL 9006
- mounting frames MODUL 2x7M included
- in accordance with EN 5005-1 and EN 50085-2-2

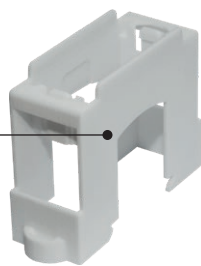
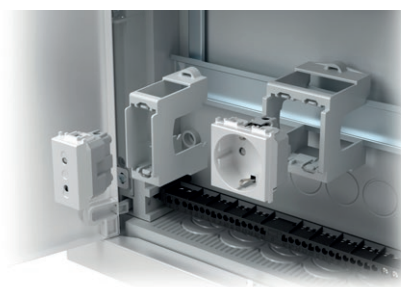
RB10

Iloji type	përshkrimi description	të dhënat teknike technical data
RB10	PËRSHTATËS PËR SHINË DIN ADAPTER FOR DIN RAIL	35mm 1M
RB11	PËRSHTATËS PËR SHINË DIN ADAPTER FOR DIN RAIL	35mm 2M
·	KUTI SHPËRNDARJEJE	·
·	·	·
·	·	·

PËRSHTATËS PËR SHINË DIN 35 mm 1M

RB10

- përshtatës MODUL 1M
- për shinë DIN 35 mm
- në përputhje me EN 50022

ADAPTER FOR DIN RAIL 35mm 1M

- adapter MODUL 1M
- for DIN rail 35mm
- in accordance with EN 50022

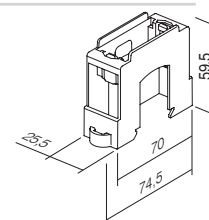

PËRSHTATËS PËR SHINË DIN 35 mm 2M

RB11

- përshtatës MODUL 2M
- për shinë DIN 35 mm
- në përputhje me EN 50022

ADAPTER FOR DIN RAIL 35mm 2M

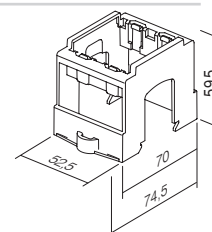
- adapter MODUL 2M
- for DIN rail 35mm
- in accordance with EN 50022



SWITCH
LOGIQ



TEM

LOGIQ

VETËBESIM I PRANISHËM KUDO **krijuar për çdo dhomë**

Një formë për çdo dhomë. Çelësat kanë linja universale që lënë shenjë si në ambiente moderne pune ashtu edhe në hapësira të rehatshme ndenjeje. Familja LOGIQ ofron një zgjidhje të thjeshtë dhe logjike për çdo dëshirë tuajën.

OMNIPRESENT CONFIDENCE **made for every room**

A shape for every room. The switches have universal lines that leave a mark in both modern work environments as well as in cosy, comfortable living spaces. The LOGIQ family offers a simple and logical solution for your every wish.



LOGIQ

HARMONIA E NGJYRAVE **Zgjidhni nuancën tuaj**

Familja LOGIQ është krenare për gamën e saj logjike të nuancave të verifikuara dhe elegante të njohura dhe të pëlqyera nga klientët tanë. Mos bëni kompromise, familja LOGIQ e ka zgjidhjen për ju. Ne mund të krijojmë në çdo kohë nuancën e një ngjyre në përputhje me kërkesën tuaj të veçantë. Logjikisht.

HARMONY OF COLOURS **Choose your hue**

The LOGIQ family prides itself on its logical range of verified and elegant hues known and loved by our clients. Don't compromise, the LOGIQ family has you covered. We can always create the hue of colour in accordance with your special request. Logically.

- **antracit** *anthracite*
- **titan** *titanium*
- **e bardhë polare** *polar white*



IMAGJINATË PA KUFI **Krijoni kombinimin tuaj**

Familja LOGIQ ju lejon të krijoni kombinimin tuaj. Për ta bërë kombinimin të thjeshtë, kemi krijuar një sistem të dobishëm që mbështet renditjen e linjave horizontale dhe vertikale. Sistemi i ashtuquajtur 55/55 ju lejon të përdorni të njëjtat elemente universale çdo herë. E dini se çfarë dëshironi? Mos u shqetësoni, pasi çelësat LOGIQ mund t'ju lexojnë mendjen.

LIMITLESS IMAGINATION Create your own combination

The LOGIQ family allows you to create your own combination. To make combining simple, we have created a useful system that supports the sequencing of horizontal and vertical lines. The so-called 55/55 system allows you to use the same universal elements every time. Know what you want? Don't worry, the LOGIQ switches can read your mind.



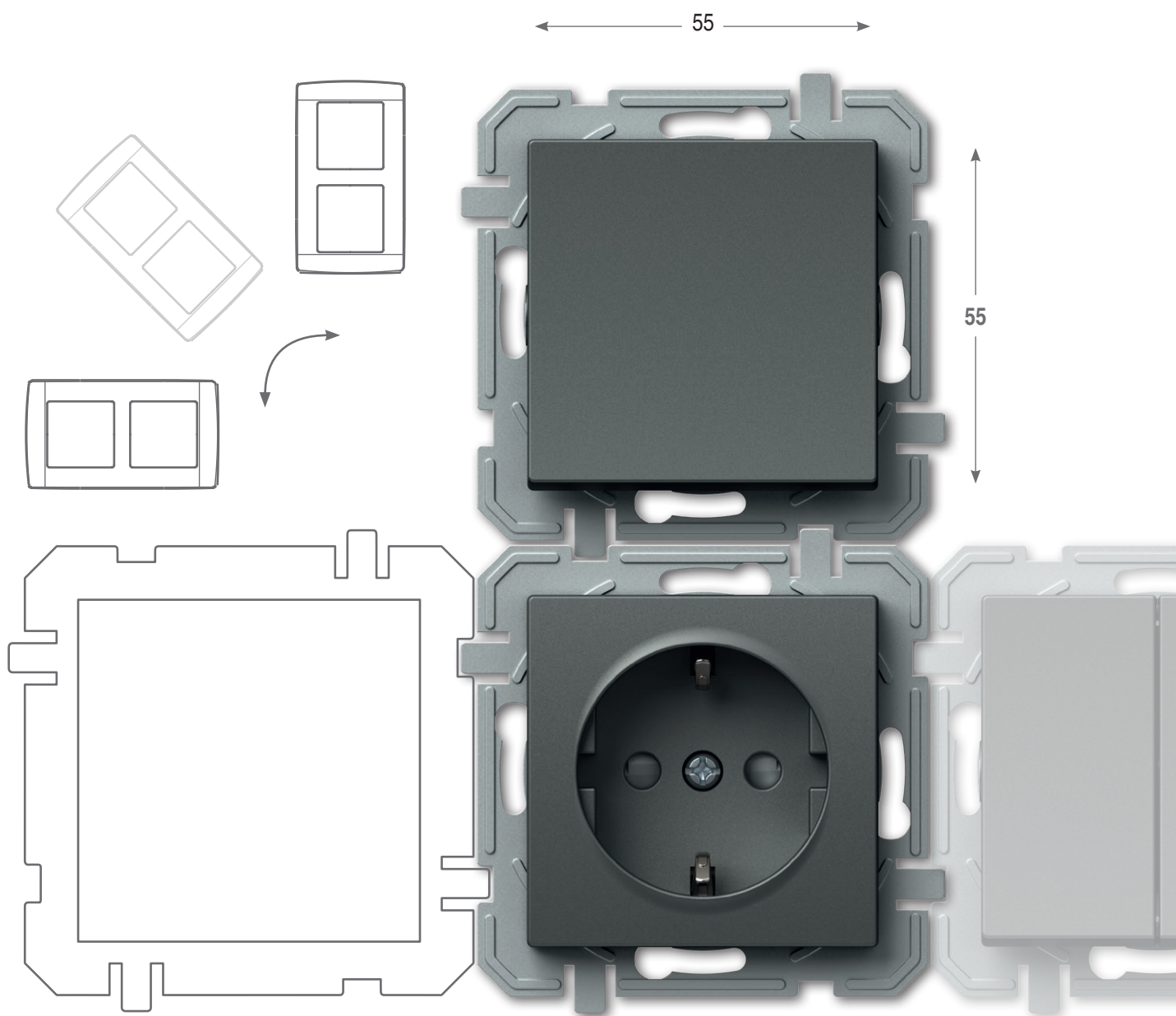

TË THJESHTË EDHE PËR PERSONAT MË KËRKUES

Familja LOGIQ ofron çelësa, rregullatorë, sensorë, dhe priza për çdo qëllim në një vend të vetëm. Mund t'i përdorni këto produkte individualisht ose në një sekuençë. Si çdo familje rritet dhe zhvillohet, familja LOGIQ do të vazhdojë të zhvillojë gamën tonë të produkteve në përputhje me nevojat dhe dëshirat tuaja. Ne ju dëgjojmë me kënaqësi dhe ofrojmë një zgjidhje e cila do të vazhdojë thjesht dhe logjikisht historinë e familjes LOGIQ.

SIMPLE FOR THE MOST DEMANDING

The LOGIQ family offers switches, regulators, sensors, and sockets for every purpose in one place. You can use these products individually or in a sequence. Just like every family that grows and develops, the LOGIQ family will continue to develop our range of products in accordance with your needs and wishes. We are happy to listen to you and offer a solution which will simply and logically continue the story of the LOGIQ family.

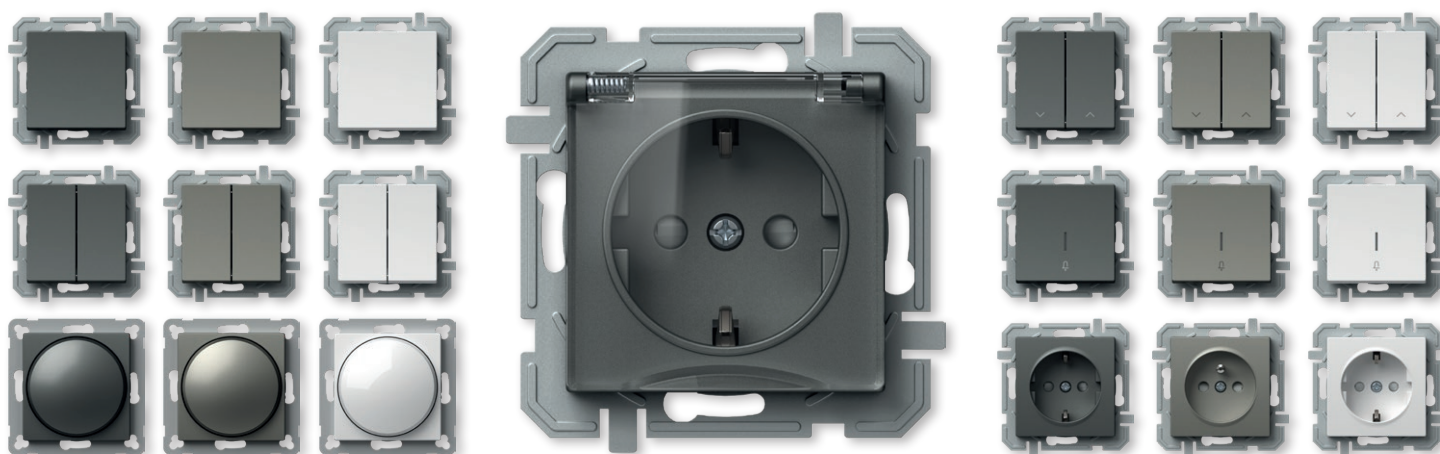

TË GJITHA NË NJË VEND DHE MË TEPËR

ALL IN ONE PLACE AND MORE

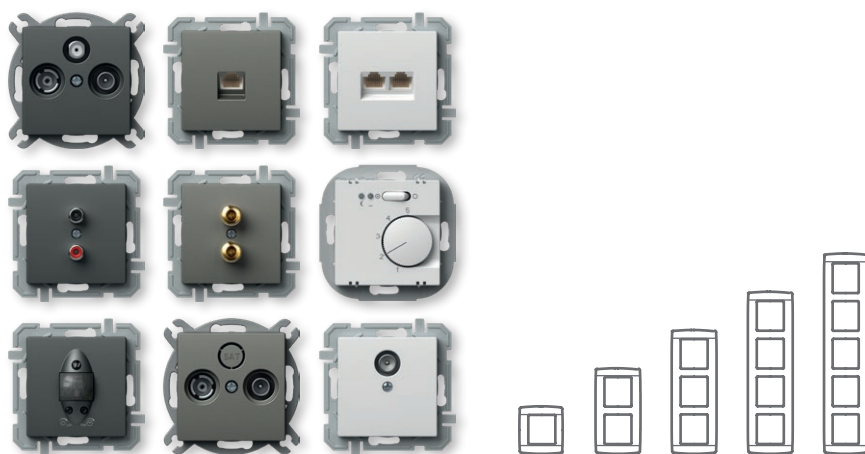

INSTALIMI LOGJIK

LOGIQ është një zgjidhje për sistemin e kutive të standardizuara të rrumbullakëta të instalimit. Ai mund të përdoret për instalime të thjeshta, si dhe të komplikuar, ndërtesa të reja dhe përshtatje. Sistemi karakterizohet nga kontakte për futje telash që kursejnë kohë gjatë instalimit të elementeve.

LOGICAL INSTALLATION

LOGIQ is a solution for the system of standardized round installations boxes. It can be used for simple as well as more demanding installations, new buildings and adaptations. The system is characterised by plug-in contacts which save time during installation of elements.

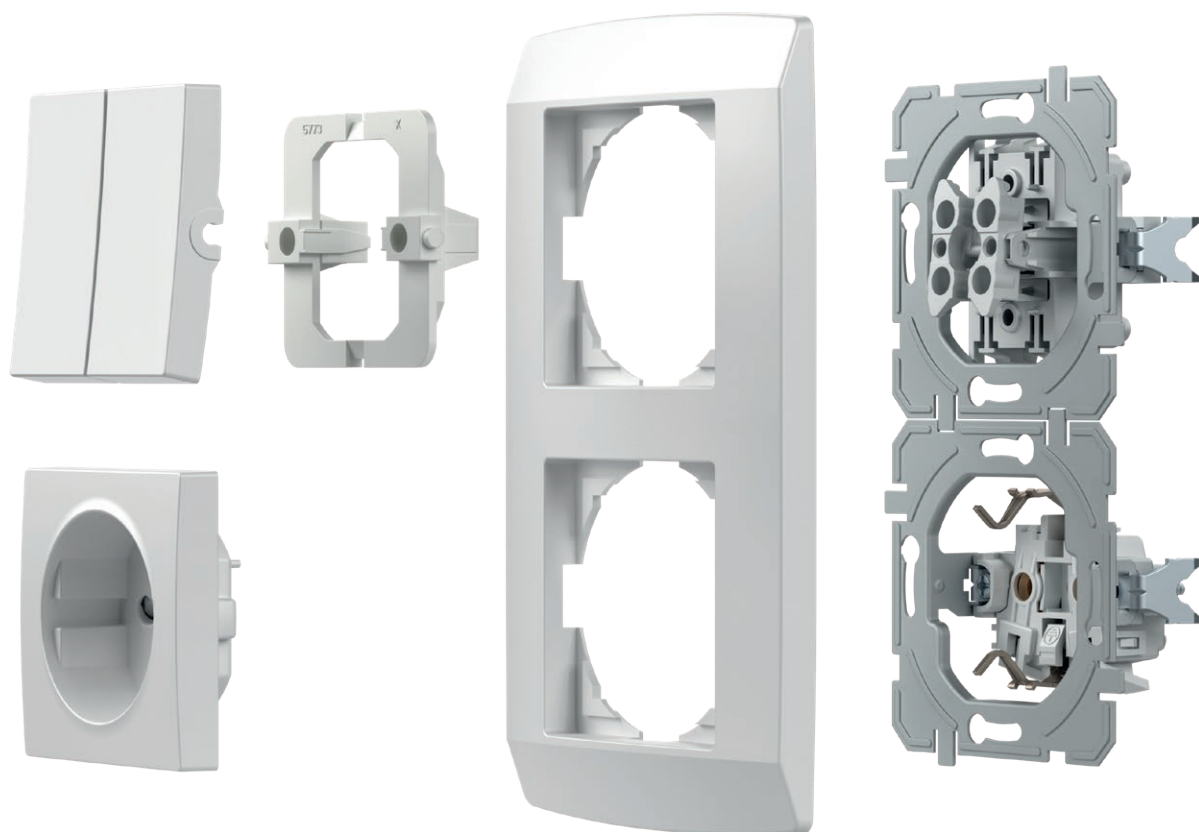

INFORMACION I DOBISHËM

GOOD TO KNOW



Të gjitha prizat janë të pajisura me mbyllëse sigurie që garantojnë mbrojtjen e kontakteve nën tension.

All the sockets are equipped with a safety shutters assuring the protection to live contacts.



Dizajni i mirëmenduar i çelësit mundëson integrimin e thjeshtë të treguesit, edhe në një moment të mëvonshëm.

The well-thought-out design of the switch enables the easy integration of the indication, including at a later time.



Kontaktet prej aliazhi argjendi garantojnë komutimin e sigurt.

Contacts made of silver alloy guarantee safe switching.



Kontaktet për futjen e telave mundësojnë bashkim të shpejtë dhe të sigurt të telave. Dy tela me diametër të ndryshëm mund të bashkohen me të njëjtin kontakt.

Plug-in contacts enable quick and reliable attachment of wires. Two wires of different diameters can be attached to the same contact.



Kapëset fiksuese mundësojnë fiksime më të thellë (gjithashtu përmes pllakave qeramike etj.)

Fixing claws enable deeper fixing (also through ceramic tiles, etc.)









Kutitë e instalimit me montim të lehtë do t'ju lehtësojnë punën. Gjatësitë e duhura janë të garantuara.

Easy-fitting installation boxes will make your work easier. Proper lengths are guaranteed.



SQ11 PW IN 01 XO

Iloji type	përshkrimi description	të dhënat teknike technical data	ngjyra colour	të dhënat opsionale 1 optional data 1	të dhënat opsionale 2 optional data 2	të dhënat opsionale 3 optional data 3
SQ10	ÇELËS ME 1 DREJTIM SWITCH 1WAY	10AX 250V~	<input type="checkbox"/> PW e bardhë polare polar white	 NT neutral neutral	 01	XO pa kapak mbulues without cover plate
SQ11	BUTON ME SHTYPJE ME 1 DREJTIM PUSH BUTTON 1WAY	10A 250V~	<input type="checkbox"/> TI titan titanium	 IN treguesi indicator	 02	
SQ22	ÇELËS 2-POLAR SWITCH 2POLE	16AX 250V~	<input type="checkbox"/> AT antracit anthracite		 03	
...

ÇELËS ME 1 DREJTIM 10 AX 250 V~

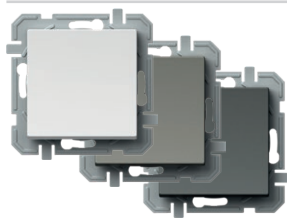

- SQ10PWXO
- SQ10TIXO
- SQ10ATXO



- 10 AX 250 V~, Iloji SQ10
- në përputhje me EN 60669-1
- kontakte për futje telash 1,5-2,5 mm²
SWITCH 1WAY 10AX 250V~
- 10AX 250V~, type SQ10
- in accordance with EN 60669-1
- plug-in contacts 1.5-2.5mm²



ÇELËS ME 1 DREJTIM 10 AX 250 V~ __ IN

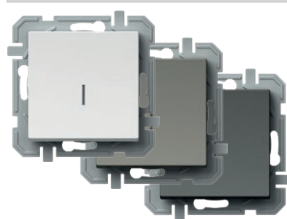

- SQ10PWINXO
- SQ10TIINXO
- SQ10ATINXO

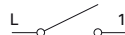

- tregues IN, pa llambë neoni
- 10 AX 250 V~, Iloji SQ10
- në përputhje me EN 60669-1
- kontakte për futje telash 1,5-2,5 mm²
SWITCH 1WAY 10AX 250V~ __ IN
- IN indicator, without neon lamp
- 10AX 250V~, type SQ10
- in accordance with EN 60669-1
- plug-in contacts 1.5-2.5mm²



BUTON ME SHTYPJE ME 1 DREJTIM 10A 250 V~

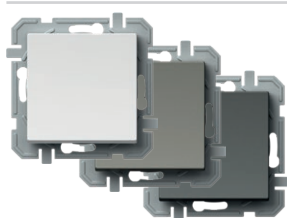

- SQ11PWXO
- SQ11TIXO
- SQ11ATXO



- 10 A 250 V~, Iloji SQ11
- në përputhje me EN 60669-1
- kontakte për futje telash 1,5-2,5 mm²
PUSH BUTTON 1WAY 10A 250V~
- 10A 250V~, type SQ11
- in accordance with EN 60669-1
- plug-in contacts 1.5-2.5mm²



BUTON ME SHTYPJE ME 1 DREJTIM 10A 250V~ __ IN 01



- SQ11PWIN01XO
- SQ11TIIN01XO
- SQ11ATIN01XO



- tregues IN 01 me zile, pa llambë neoni
- 10 A 250 V~, Iloji SQ11
- në përputhje me EN 60669-1
- kontakte për futje telash 1,5-2,5 mm²
PUSH BUTTON 1WAY 10A 250V~ __ IN 01
- IN 01 indicator bell, without neon lamp
- 10A 250V~, type SQ11
- in accordance with EN 60669-1
- plug-in contacts 1.5-2.5mm²





- SQ11PWIN02XO
- SQ11TIIN02XO
- SQ11ATIN02XO

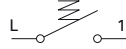

BUTON ME SHYTPJE ME 1 DREJTIM 10 A 250 V~ __ IN 02

- dritë treguese IN 02, pa llambë neoni
- 10 A 250 V~, Iloji SQ11
- në përputhje me EN 60669-1
- kontakte për futje telash 1,5-2,5 mm²

PUSH BUTTON 1WAY 10A 250V~ __ IN 02

- IN 02 indicator light, without neon lamp
- 10A 250V~, type SQ11
- in accordance with EN 60669-1
- plug-in contacts 1.5-2.5mm²

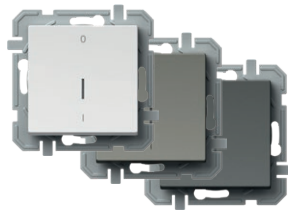

- SQ22PWIN03XO
- SQ22TIIN03XO
- SQ22ATIN03XO

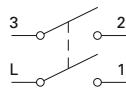

ÇELËS 2-POLAR 16 AX 250 V~ __ IN 03

- IN 03 neutral 0-1, pa llambë neoni
- 16 AX 250 V~, Iloji SQ22
- në përputhje me EN 60669-1
- kontaktet e vidave 1,5-2,5 mm²

SWITCH 2POLE 16AX 250V~ __ IN 03

- IN 03 neutral 0-1, without neon lamp
- 16AX 250V~, type SQ22
- in accordance with EN 60669-1
- screw contacts 1.5-2.5mm²



- SQ50PWXO
- SQ50TIXO
- SQ50ATXO

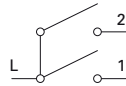

ÇELËS ME 2 VENDE - 1 DREJTIM 10 AX 250 V~

- 10 AX 250 V~, Iloji SQ50
- në përputhje me EN 60669-1
- kontakte për futje telash 1,5-2,5 mm²

SWITCH 2GANG-1WAY 10AX 250V~

- 10AX 250V~, type SQ50
- in accordance with EN 60669-1
- plug-in contacts 1.5-2.5mm²

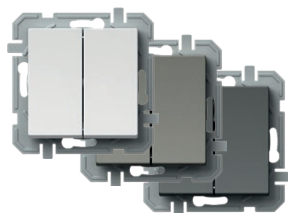

- SQ51PWXO
- SQ51TIXO
- SQ51ATXO

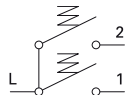

BUTON ME SHYTPJE ME 2 VENDE - 1 DREJTIM 10 A 250 V

- 10 A 250 V~, Iloji SQ51
- në përputhje me EN 60669-1
- kontakte për futje telash 1,5-2,5 mm²

PUSH BUTTON 2GANG-1WAY 10A 250V~

- 10A 250V~, type SQ51
- in accordance with EN 60669-1
- plug-in contacts 1.5-2.5mm²



- SQ52PWNT09XO
- SQ52TINT09XO
- SQ52ATNT09XO

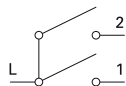

MBYLLËSE ÇELËSI 10 AX 250 V~ __ NT 09

- NT 09 neutral lart-poshtë
- 10 AX 250 V~, Iloji SQ52
- në përputhje me EN 60669-1
- kontakte për futje telash 1,5-2,5 mm²
- me bllokim mekanik

SWITCH SHUTTERS 10AX 250V~ __ NT 09

- NT 09 neutral up-down
- 10AX 250V~, type SQ52
- in accordance with EN 60669-1
- plug-in contacts 1.5-2.5mm²
- with mechanical interblock



- SQ53PWNT09XO
- SQ53TINT09XO
- SQ53ATNT09XO

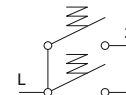

MBYLLËSE BUTONI ME SHYTPJE 10 A 250 V~ __ NT 09

- NT 09 neutral lart-poshtë
- 10 A 250 V~, Iloji SQ53
- në përputhje me EN 60669-1
- kontakte për futje telash 1,5-2,5 mm²
- me bllokim mekanik

PUSH BUTTON SHUTTERS 10A 250V~ __ NT 09

- NT 09 neutral up-down
- 10A 250V~, type SQ53
- in accordance with EN 60669-1
- plug-in contacts 1.5-2.5mm²
- with mechanical interblock

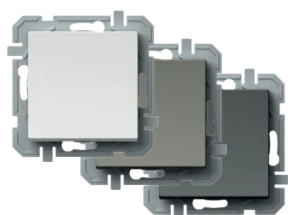

- SQ60PWXO
- SQ60TIXO
- SQ60ATXO

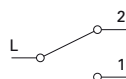

ÇELËS ME 2 DREJTIME 10 AX 250 V~

- 10 AX 250 V~, Iloji SQ60
- në përputhje me EN 60669-1
- kontakte për futje telash 1,5-2,5 mm²

SWITCH 2WAY 10AX 250V~

- 10AX 250V~, type SQ60
- in accordance with EN 60669-1
- plug-in contacts 1.5-2.5mm²

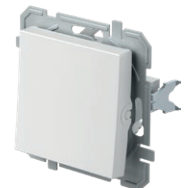

ÇELËS DYSH ME 2 DREJTIME 10 A X 250 V~



- SQ63PWXO
- SQ63TIXO
- SQ63ATXO

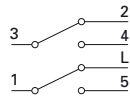

- 10 AX 250 V~, Iloji SQ63
 - në përputhje me EN 60669-1
 - kontakte për futje telash 1,5-2,5 mm²
SWITCH DOUBLE 2WAY 10AX 250V~
 - 10AX 250V~, type SQ63
 - in accordance with EN 60669-1
 - plug-in contacts 1.5-2.5mm²



ÇELËS NDËRMJETËS 10 AX 250 V~

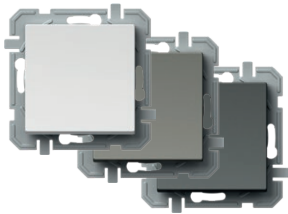

- SQ70PWXO
- SQ70TIXO
- SQ70ATXO

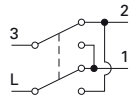

- 10 AX 250 V~, Iloji SQ70
 - në përputhje me EN 60669-1
 - kontakte për futje telash 1,5-2,5 mm²
SWITCH INTERMEDIATE 10AX 250V~
 - 10AX 250V~, type SQ70
 - in accordance with EN 60669-1
 - plug-in contacts 1.5-2.5mm²



SQ10
SQ11

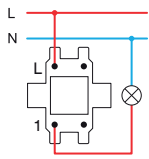

SQ22

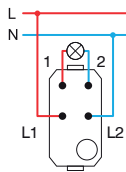

SQ50
SQ51

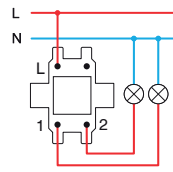

SQ52
SQ53

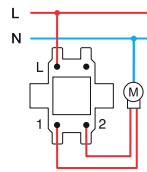

SQ60+SQ60

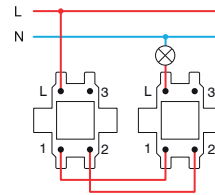

SQ63+SQ63

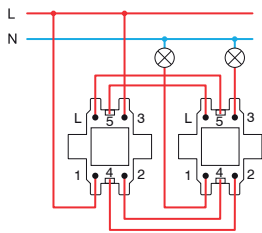

SQ60+SQ70+SQ60

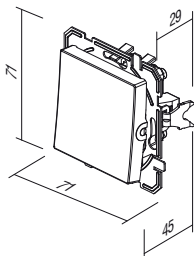
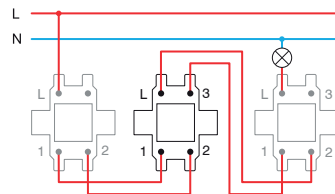

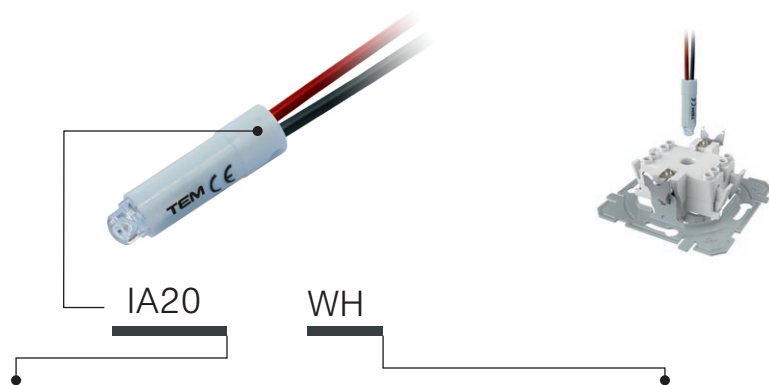

Iloji type	përshkrimi description	të dhënat teknike technical data	ngjyra colour
IA10	LLAMBË NEONI NEON LAMP	230V~ 0,34W	<input type="checkbox"/> WH e bardhë white
IA20	SINJALIZIMI LED LED SIGNALLING UNIT	230V~ 0,40W	<input checked="" type="checkbox"/> BL blu blue
IA21	SINJALIZIMI LED LED SIGNALLING UNIT	24V AC/DC 0,20W	<input checked="" type="checkbox"/> RD e kuqe red
.	.	.	<input checked="" type="checkbox"/> GR e gjelbër green
.	.	.	<input checked="" type="checkbox"/> OR portokalli orange

LLAMBË NEONI 230 V~ 0,34 W



IA10OR

- për indikim, sinjalizim ose sinjalizim të përhershëm
- në kombinim me një buton që ka një tregues

NEON LAMP 230V~ 0,34W

- for indication, signalling or permanent signalling
- in combination with a button featuring an indicator

SINJALIZIMI LED 230 V AC/DC 0,40 W

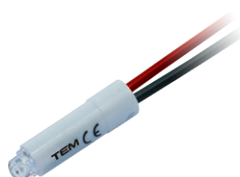

IA20WH
 IA20GR
 IA20RD
 IA20BL

- për indikim, sinjalizim ose sinjalizim të përhershëm
- në kombinim me një buton që ka një tregues

LED SIGNALLING UNIT 230V AC/DC 0,40W

- for indication, signalling or permanent signalling
- in combination with a button featuring an indicator

SINJALIZIMI LED 24 V AC/DC 0,20 W



IA21WH
 IA21RD

- për indikim, sinjalizim ose sinjalizim të përhershëm
- në kombinim me një buton që ka një tregues

LED SIGNALLING UNIT 24V AC/DC 0,20W

- for indication, signalling or permanent signalling
- in combination with a button featuring an indicator

SINJALIZIMI LED 12 V AC/DC 0,10 W

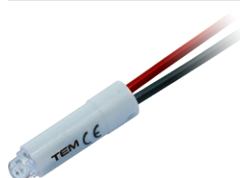

IA22WH
 IA22RD

- për indikim, sinjalizim ose sinjalizim të përhershëm
- në kombinim me një buton që ka një tregues

LED SIGNALLING UNIT 12V AC/DC 0,10W

- for indication, signalling or permanent signalling
- in combination with a button featuring an indicator

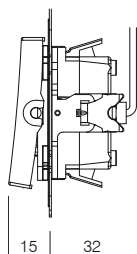

15

32

Tregues
Indication

*Sinjalizimi
Signalization

Sinjalizimi i përhershëm
Permanent signalling

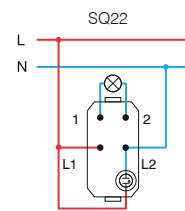
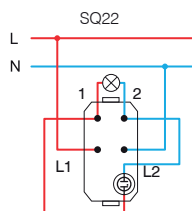
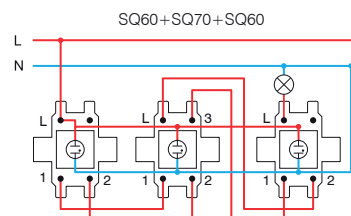
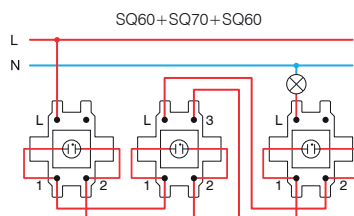
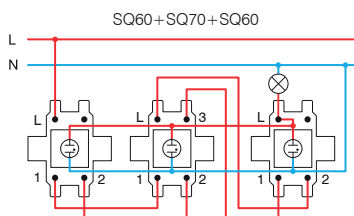
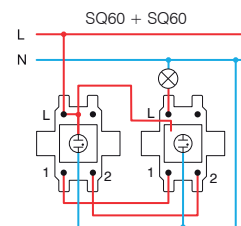
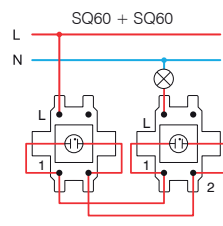
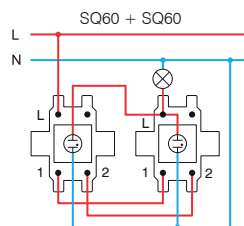
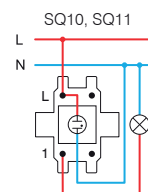
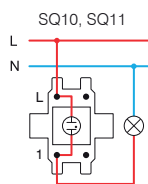
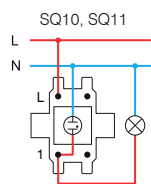

* lidhjet janë të papërshtatshme për llamba që kursejnë energji (CFL, LED) /
the connections are not suitable for energy-saving bulbs (CFL, LED)

S O C K E T S V Q

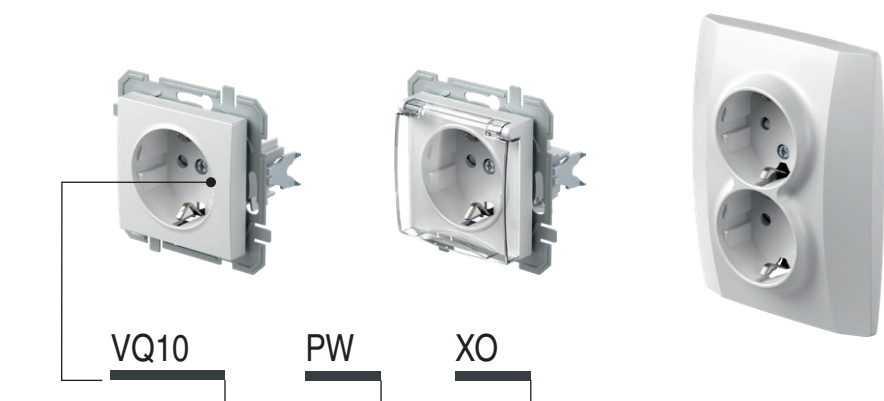

Iloji type	përshkrimi description	të dhënat teknike technical data	të dhënat opsionale 1 optional data 1
VQ10	PRIZË SCHUKO SOCKET SCHUKO	2P+E 16A 250V~	XO pa kapak mbulues without cover plate
VQ11	PRIZË SCHUKO+KAPAK SOCKET SCHUKO+COVER	2P+E 16A 250V~	
VQ12	PRIZË SCHUKO SOCKET SCHUKO	2P+E 16A 250V~ BV	
:	:	:	
:	:	:	

ngjyra
colour

PW e bardhë polare polar white	PT e bardhë+transparente white+transparent	PP e bardhë+e bardhë white+white
TI titan titanium	TT titan+transparente titanium+transparent	TI titan+titan titanium+titanium
AT antracit anthracite	AT antracit+transparente anthracite+transparent	AA antracit+antracit anthracite+anthracite
RD e kuqe red	RT e kuqe+transparente red+transparent	RR e kuqe+e kuqe red+red
GR e gjelbër green	GT e gjelbër+transparente green+transparent	GG e gjelbër+e gjelbër green+green
OR portokalli orange	OT portokalli+transparente orange+transparent	OO portokalli+portokalli orange+orange



schuko - në përputhje me EN 60884-1, CEE7 (fleta e standardit III)

schuko - in accordance with EN 60884-1, CEE7 (standard sheet III)

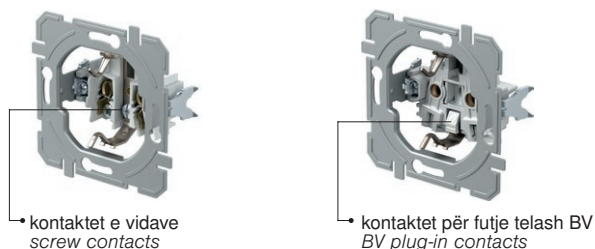

• kontaktet e vidave
screw contacts

• kontaktet për futje telash BV
BV plug-in contacts

PRIZË SCHUKO 2P+E 16 A 250 V~ __ XO

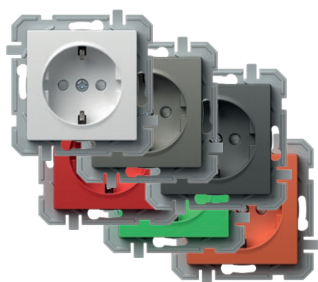

- VQ10PWXO
- VQ10TIXO
- VQ10ATXO
- VQ10RDXO
- VQ10GRXO
- VQ10ORXO

- kontaktet e vidave 1,5-2,5 mm²
- XO pa kapak mbulues
- schuko 2P+E
- 16 A 250 V~, lloji VQ10
- kontaktet me rrymën të mbuluara



SOCKET SCHUKO 2P+E 16A 250V~ __ XO

- screw contacts 1.5-2.5mm²
- XO without surround
- 2P+E schuko
- 16A 250V~, type VQ10
- shuttered live contacts

PRIZË SCHUKO+KAPAK 2P+E 16 A 250 V~ __ XO

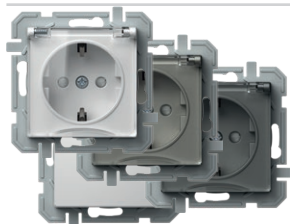

- VQ11PTXO
- VQ11TTXO
- VQ11ATXO
- VQ11PPXO

- kontaktet e vidave 1,5-2,5 mm²
- XO pa kapak mbulues
- schuko 2P+E schuko+kapak
- 16 A 250 V~, lloji VQ11
- kontaktet me rrymën të mbuluara



SOCKET SCHUKO+COVER 2P+E 16A 250V~ __ XO

- screw contacts 1.5-2.5mm²
- XO without surround
- 2P+E schuko+cover
- 16A 250V~, type VQ11
- shuttered live contacts

PRIZË SCHUKO 2P+E 16 A 250 V~ BV __ XO

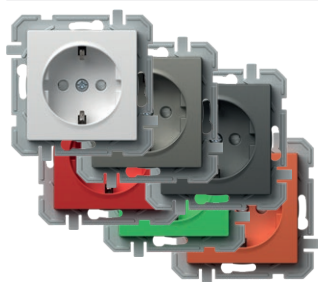

- VQ12PWXO
- VQ12TIXO
- VQ12ATXO
- VQ12RDXO
- VQ12GRXO
- VQ12ORXO

- BV kontakte për futje telash 1,5-2,5 mm²
- XO pa kapak mbulues
- schuko 2P+E
- 16 A 250 V~, lloji VQ12
- kontaktet me rrymën të mbuluara



SOCKET SCHUKO 2P+E 16A 250V~ BV __ XO

- BV plug-in contacts 1.5-2.5mm²
- XO without surround
- 2P+E schuko
- 16A 250V~, type VQ12
- shuttered live contacts

PRIZË SCHUKO+KAPAK 2P+E 16 A 250 V~ BV __ XO



- VQ13PTXO
- VQ13TTXO
- VQ13ATXO
- VQ13PPXO

- kontakte BV për futje telash 1,5-2,5 mm²
- XO pa kapak mbulues
- schuko 2P+E schuko+kapak
- 16 A 250 V~, lloji VQ13
- kontaktet me rrymën të mbuluara



SOCKET SCHUKO+COVER 2P+E 16A 250V~ BV __ XO

- BV plug-in contacts 1.5-2.5mm²
- XO without surround
- 2P+E schuko+cover
- 16A 250V~, type VQ13
- shuttered live contacts

PRIZË SCHUKO DYSHE 2P+E 16 A 250 V~



- VQ16PW
- VQ16TI
- VQ16AT

- schuko dyshe 2P+E
- 16 A 250 V~, lloji VQ16
- në përputhje me IEC 60884-1, CEE7
- kontaktet e vidave 1,5-2,5 mm²
- kontaktet me rrymën të mbuluara



SOCKET SCHUKO DOUBLE 2P+E 16A 250V~

- 2P+E schuko double
- 16A 250V~, type VQ16
- in accordance with IEC 60884-1, CEE7
- screw contacts 1.5-2.5 mm²
- shuttered live contacts

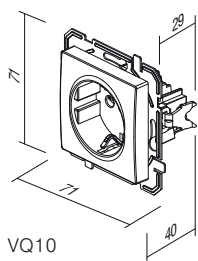

VQ10

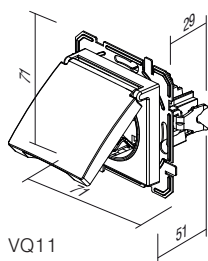

VQ11

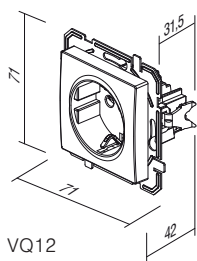

VQ12

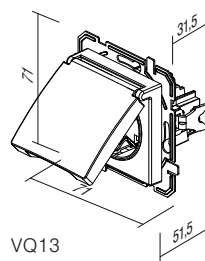

VQ13

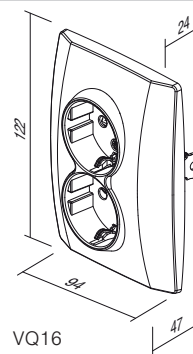

VQ16

S O C K E T S V Q

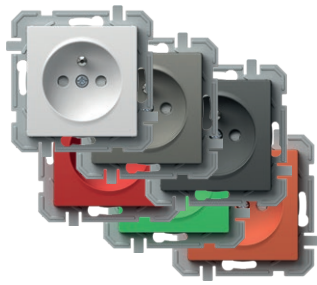

- VQ40PWXO
- VQ40TIXO
- VQ40ATXO
- VQ40RDXO
- VQ40GRXO
- VQ40ORXO

PRIZË FRANCEZE 2P+E 16 A 250 V~ __ XO

- kontaktet e vidave 1,5-2,5 mm²
- XO pa kapak mbulues
- 2P+E Franceze
- 16 A 250 V~, lloji VQ40
- kontaktet me rrymën të mbuluara

SOCKET FRENCH 2P+E 16A 250V~ __ XO

- screw contacts 1.5-2.5mm²
- XO without surround
- 2P+E French
- 16A 250V~, type VQ40
- shuttered live contacts



- VQ41PTXO
- VQ41TTXO
- VQ41ATXO
- VQ41PPXO

PRIZË FRANCEZE+KAPAK 2P+E 16 A 250 V~ __ XO

- kontaktet e vidave 1,5-2,5 mm²
- XO pa kapak mbulues
- 2P+E Franceze+kapak
- 16 A 250 V~, lloji VQ41
- kontaktet me rrymën të mbuluara

SOCKET FRENCH+COVER 2P+E 16A 250V~ __ XO

- screw contacts 1.5-2.5mm²
- XO without surround
- 2P+E French+cover
- 16A 250V~, type VQ41
- shuttered live contacts



- VQ42PWXO
- VQ42TIXO
- VQ42ATXO

PRIZË FRANCEZE 2P+E 16 A 250 V~ BV __ XO

- BV kontakte për futje telash 1,5-2,5 mm²
- XO pa kapak mbulues
- 2P+E Franceze
- 16 A 250 V~, lloji VQ42
- kontaktet me rrymën të mbuluara

SOCKET FRENCH 2P+E 16A 250V~ BV __ XO

- BV plug-in contacts 1.5-2.5mm²
- XO without surround
- 2P+E French
- 16A 250V~, type VQ42
- shuttered live contacts



- VQ43PTXO
- VQ43TTXO
- VQ43ATXO
- VQ43PPXO

PRIZË FRANCEZE+KAPAK 2P+E 16 A 250 V~ BV __ XO

- BV kontakte për futje telash 1,5-2,5 mm²
- XO pa kapak mbulues
- 2P+E Franceze+kapak
- 16 A 250 V~, lloji VQ43
- kontaktet me rrymën të mbuluara

SOCKET FRENCH+COVER 2P+E 16A 250V~ BV __ XO

- BV plug-in contacts 1.5-2.5mm²
- XO without surround
- 2P+E French+cover
- 16A 250V~, type VQ43
- shuttered live contacts



- VQ46PWXO
- VQ46TIXO
- VQ46ATXO

PRIZË FRANCEZE DYSHE 2P+E 16 A 250 V~

- 2P+E franceze dyshe
- 16 A 250 V~, lloji VQ46
- në përputhje me IEC 60884-1, CEE7; NF C 61-314, CSN 33 2318; PN-E 93201
- kontaktet e vidave 1,5-2,5 mm²
- kontaktet me rrymën të mbuluara

SOCKET FRENCH DOUBLE 2P+E 16A 250V~

- 2P+E French double
- 16A 250V~, type VQ46
- in accordance with IEC 60884-1, CEE7; NF C 61-314, CSN 33 2318; PN-E 93201
- screw contacts 1,5-2,5 mm²
- shuttered live contacts

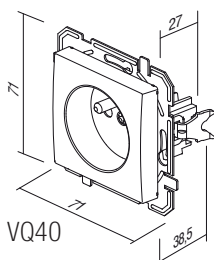

VQ40

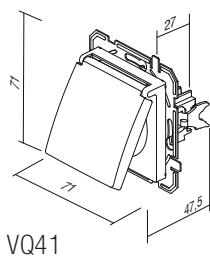

VQ41

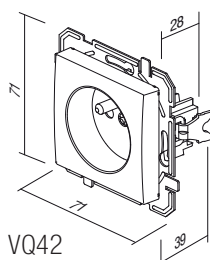

VQ42

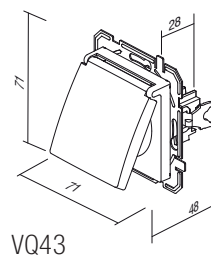

VQ43

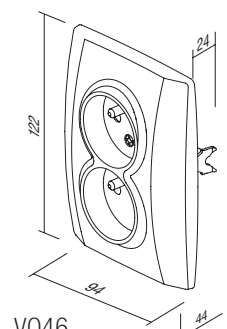

VQ46

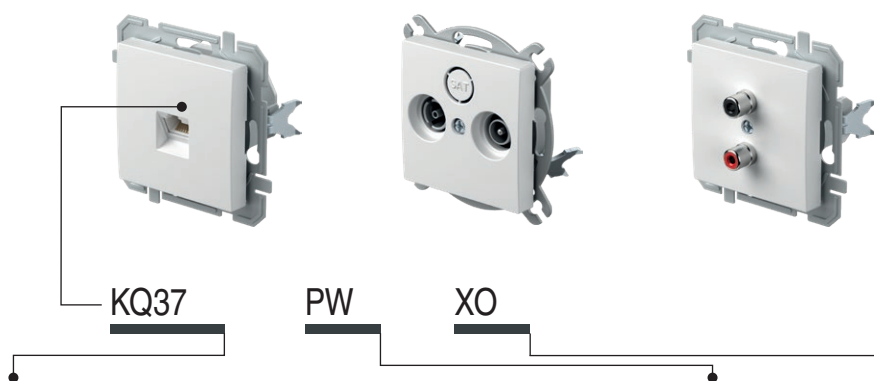

lloji type	përshkrimi description	të dhënat teknike technical data	ngjyra colour	të dhënat opsionale 1 optional data 1
KQ11	PRIZË TV-R ME KAPAK FUNDOR SOCKET TV-R END-LINE	1dB	<input type="checkbox"/> PW e bardhë polare polar white	XO pa kapak mbulues without cover plate
KQ12	PRIZË TV-R KALUESE SOCKET TV-R THROUGHPASS	10dB	<input type="checkbox"/> TI titan titanium	
KQ16	PRIZË SAT-TV-R ME KAPAK FUNDOR SOCKET SAT-TV-R END-LINE	3dB	<input type="checkbox"/> AT antracit anthracite	
...				

PRIZË TV BAZË 0 dB



- KQ10PWXO
- KQ10TIXO
- KQ10ATXO

- TV bazë
- reduktim 0 dB
- konektor i pasmë – F standard

SOCKET TV BASIC 0dB

- TV basic
- reduction 0dB
- back connector – F standard



PRIZË TV-R ME KAPAK FUNDOR 1 dB



- KQ11PWXO
- KQ11TIXO
- KQ11ATXO

- TV-R me kapak fundor
- gama e frekuencës 5÷862 MHz
- reduktimi: R-1,5 dB, TV-1 dB
- në përputhje me EN 50083-1
- kontakti i vidave

SOCKET TV-R END-LINE 1dB

- TV-R end-line
- frequency range 5÷862 MHz
- reduction: R-1.5dB, TV-1dB
- in accordance with EN 50083-1
- screw contact



PRIZË TV-R KALUESE 10 dB



- KQ12PWXO
- KQ12TIXO
- KQ12ATXO

- TV-R kaluese
- gama e frekuencës 5÷862 MHz
- reduktimi: R-10 dB, TV-10 dB, kaluese-2 dB
- në përputhje me EN 50083-1
- kontaktet e vidave

SOCKET TV-R TROUGHPASS 10dB

- TV-R troughpass
- frequency range 5÷862 MHz
- reduction: R-10dB, TV-10dB, trough-2dB
- in accordance with EN 50083-1
- screw contacts



PRIZË SAT-TV-R ME KAPAK FUNDOR 3 dB



- KQ16PWXO
- KQ16TIXO
- KQ16ATXO

- SAT-TV-R me kapak fundor
- gama e frekuencës 5÷2400 MHz
- reduktimi: R-1 dB, TV-1,5 dB, SAT-3 dB
- në përputhje me EN 50083-1
- kontaktet e vidave

SOCKET SAT-TV-R END-LINE 3dB

- SAT-TV-R end-line
- frequency range 5÷2400 MHz
- reduction: R-1dB, TV-1.5dB, SAT-3dB
- in accordance with EN 50083-1
- screw contacts



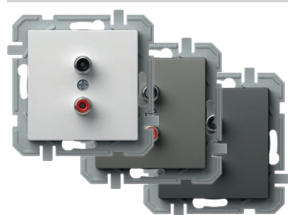

- KQ22PWXO
- KQ22TIXO
- KQ22ATXO

PRIZË AUDIO 2xRCA

- audio 2xRCA
- lidhje me saldime e kablos

SOCKET AUDIO 2xRCA

- audio 2xRCA
- soldering connection of cable



- KQ23PWXO
- KQ23TIXO
- KQ23ATXO

PRIZË AUDIO PËR ALTOPARLANTË

- audio 2x Ø4 mm
- për të mbajtur telin e altoparlantit, spinë banane Ø4mm ose pirun
- lidhje me ngjitje e kablos në pjesën e pasme

SOCKET AUDIO LOUDSPEAKERS

- audio 2x Ø4mm
- to accommodate speaker wire, banana plug Ø4mm or spades
- soldering connection of cable at the back side

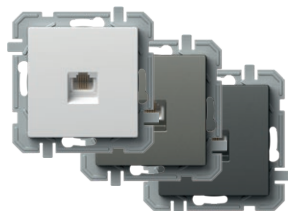

- KQ36PWXO
- KQ36TIXO
- KQ36ATXO

PRIZË TEL KS RJ11 6/4

- standard fiksues trapez KS
- RJ11 6/4
- në përputhje me IEC 60603-7

SOCKET TEL KS RJ11 6/4

- KS keystone fixing standard
- RJ11 6/4
- in accordance with IEC 60603-7

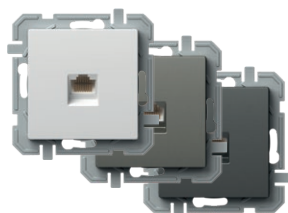

- KQ37PWXO
- KQ37TIXO
- KQ37ATXO

PRIZË CAT5e KS RJ45 8/8

- standard fiksues trapez KS
- CAT5e, RJ45 8/8
- në përputhje me IEC 60603-7

SOCKET CAT5e KS RJ45 8/8

- KS keystone fixing standard
- CAT5e, RJ45 8/8
- in accordance with IEC 60603-7

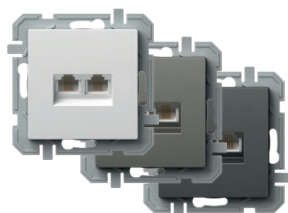

- KQ38PWXO
- KQ38TIXO
- KQ38ATXO

PRIZË TEL KS DYSHE 2x RJ11 6/4

- standard fiksues trapez KS
- 2x RJ11, 6/4
- në përputhje me IEC 60603-7

SOCKET TEL KS DOUBLE 2x RJ11 6/4

- KS keystone fixing standard
- 2x RJ11, 6/4
- in accordance with IEC 60603-7

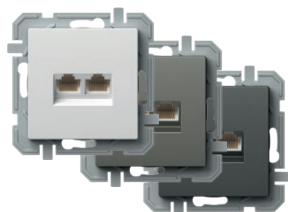

- KQ39PWXO
- KQ39TIXO
- KQ39ATXO

PRIZË CAT5e KS DYSHE 2x RJ45 8/8

- standard fiksues trapez KS
- 2x CAT5e, RJ45 8/8
- në përputhje me IEC 60603-7

SOCKET CAT5e KS DOUBLE 2x RJ45 8/8

- KS keystone fixing standard
- 2x CAT5e, RJ45 8/8
- in accordance with IEC 60603-7



- KQ35PWXO
- KQ35TIXO
- KQ35ATXO

PRIZË TEL LT RJ11 6/4

- vidë TEL LT
- kontaktet e vidave
- RJ11 6/4
- në përputhje me IEC 60603-7

SOCKET TEL LT RJ11 6/4

- TEL LT screw
- screw contacts
- RJ11 6/4
- in accordance with IEC 60603-7



PRIZË CAT6s KS RJ45 8/8 E HOLLË



- KQ40PWXO
- KQ40TIXO
- KQ40ATXO

- standard fiksues trapez KS
- CAT6s, RJ45 8/8
- në përputhje me IEC 60603-7

SOCKET CAT6s KS RJ45 8/8 SLIM

- KS keystone fixing standard
- CAT6s, RJ45 8/8
- in accordance with IEC 60603-7



PRIZË CAT6s KS DYSHE 2x RJ45 8/8 E HOLLË

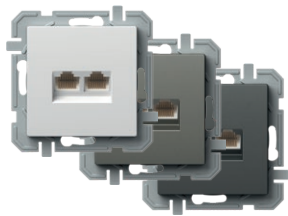

- KQ41PWXO
- KQ41TIXO
- KQ41ATXO

- standard fiksues trapez KS
- 2x CAT6s, RJ45 8/8
- në përputhje me IEC 60603-7

SOCKET CAT6s KS DOUBLE 2x RJ45 8/8 SLIM

- KS keystone fixing standard
- 2x CAT6s, RJ45 8/8
- in accordance with IEC 60603-7

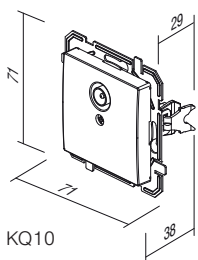

KQ10

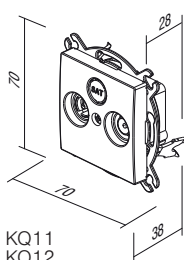

KQ11
KQ12

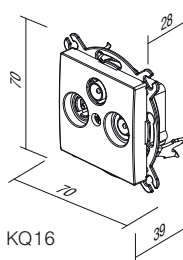

KQ16

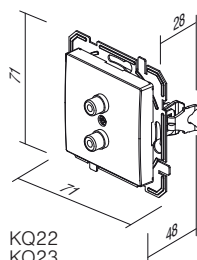

KQ22
KQ23

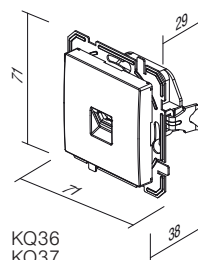

KQ36
KQ37
KQ35
KQ40

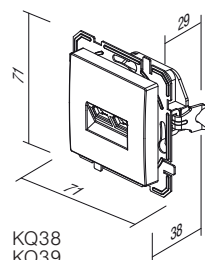

KQ38
KQ39
KQ41



EQ15

PW

XO

Iloji type	përshkrimi description	të dhënat teknike technical data	ngjyra colour	të dhënat opsionale 1 optional data 1
EQ15	REOSTAT RROTULLUES ME 2 DREJTIME DIMMER ROTATIVE 2WAY	RL 400W	<input type="checkbox"/> PW e bardhë polare polar white	XO pa kapak mbulues without cover plate
EQ16	REOSTAT RROTULLUES ME 2 DREJTIME DIMMER ROTATIVE 2WAY	RLC 400W	<input type="checkbox"/> TI titan titanium	
EQ19	REOSTAT RROTULLUES ME 2 DREJTIME DIMMER ROTATIVE 2WAY	LED 100W	<input type="checkbox"/> AT antracit anthracite	
⋮				

REOSTAT RROTULLUES ME 2 DREJTIME RL 400 W

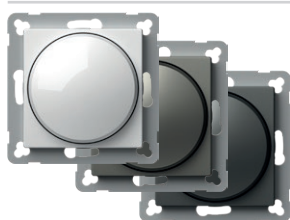

- EQ15PWXO
- EQ15TIXO
- EQ15ATXO

- kontrolli i rrotullimit me çelës me 2 drejtime
- RL i ngarkesës, 40 W - 400W
- është i mundur kombinimi i çelësit me 2 drejtime
- nuk lejohet kombinim i më shumë reostateve
- në përputhje me standardet EN 60669-1 dhe EN 60669-2-1
- kontakte për futje telash 1,5 mm²
- furnizimi, 230 V ~ 50 Hz
- përfshihet siguresa e zëvendësueshme



DIMMER ROTATIVE 2WAY RL 400W

- rotation control with 2-way switch
- load RL, 40W - 400W
- 2-way switch combination is possible
- more dimmers combination is not allowed
- in accordance with EN 60669-1 and EN 60669-2-1
- plug-in contacts 1,5mm²
- supply 230V~ 50Hz
- replaceable fuse included

REOSTAT RROTULLUES ME 2 DREJTIME RLC 400 W



- EQ16PWXO
- EQ16TIXO
- EQ16ATXO

- kontrolli i rrotullimit me çelës me 2 drejtime
- RLC i ngarkesës, 20W - 400W
- është i mundur kombinimi i çelësit me 2 drejtime
- nuk lejohet kombinim i më shumë reostateve
- në përputhje me standardet EN 60669-1 dhe EN 60669-2-1
- kontakte për futje telash 1,5 mm²
- furnizimi, 230 V ~ 50 Hz
- siguresë elektronike



DIMMER ROTATIVE 2WAY RLC 400W

- rotation control with 2-way switch
- load RLC, 20W - 400W
- 2-way switch combination is possible
- more dimmers combination is not allowed
- in accordance with EN 60669-1 and EN 60669-2-1
- plug-in contacts 1,5mm²
- supply 230V~ 50Hz
- electronic fuse

REOSTAT RROTULLUES ME 2 DREJTIME LED 100 W

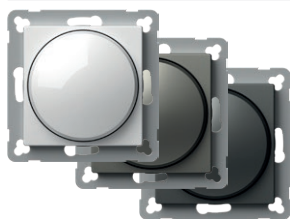

- EQ19PWXO
- EQ19TIXO
- EQ19ATXO

- kontrolli i rrotullimit me çelës me 2 drejtime
- ngarkesa: LED, 0-100 W (maks. 10 LED-e)
- GLS, 10-250 W
- është i mundur kombinimi i çelësit me 2 drejtime
- nuk lejohet kombinim i më shumë reostateve
- në përputhje me standardet EN 60669-1 dhe EN 60669-2-1
- kontakte për futje telash 1,5 mm²
- furnizimi, 230 V ~ 50 Hz
- përfshihet siguresa e zëvendësueshme



DIMMER ROTATIVE 2WAY LED 100W

- rotation control with 2-way switch
- load: LED, 0-100W (max. 10 LEDs)
- GLS, 10-250W
- 2-way switch combination is possible
- more dimmers combination is not allowed
- in accordance with EN 60669-1 and EN 60669-2-1
- plug-in contacts 1,5mm²
- supply 230V~ 50Hz
- replaceable fuse included

EQ15, EQ16, EQ19

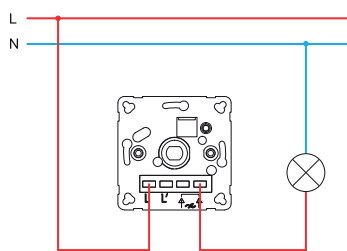

EQ15, EQ16, EQ19

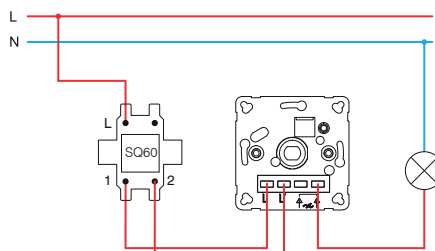

EQ15, EQ16, EQ19

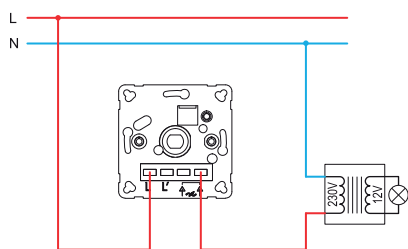

EQ15, EQ16, EQ19

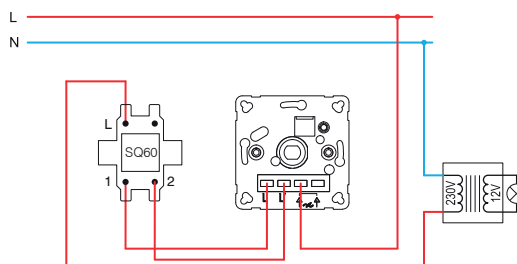

EQ16, EQ19

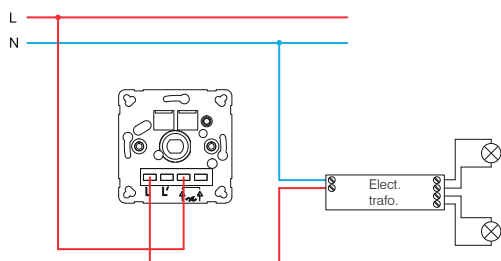

EQ16, EQ19

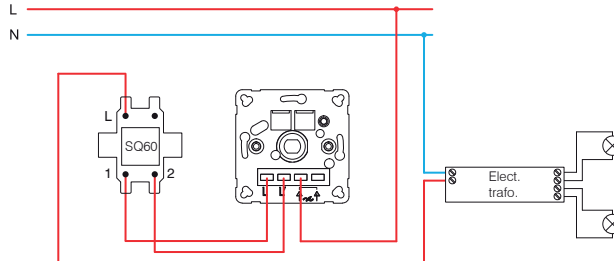

EQ15 (40÷400W)

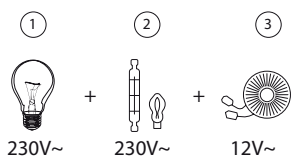

- 1 - llambë inkandeshente
incandescent lamp
- 2 - llambë halogjene
halogen lamp

EQ16 (20÷400W)

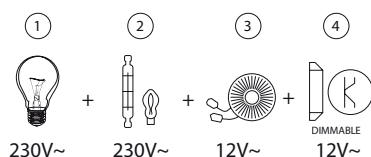

- 3 - transformator klasik
classical transformer
- 4 - transformator elektrik me ulë ndriçimi
dimmable electronic transformer

EQ19 (GLS 10÷250W ; LED 0÷100W)

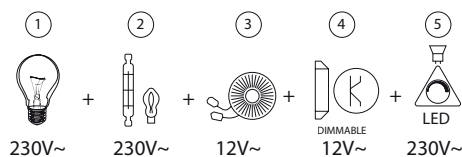

- 5 - llambë LED me ulje ndriçimi
dimmable LED lamp

ÇELËS IR 5A X 230 V~



- EQ32PWXO
- EQ32TIXO
- EQ32ATXO

- çelës IR me infra të kuqe
- tensioni i furnizimit: 230 V~ ±10 % 50 Hz
- rele: 5 A/250 V~ dalja për rrymën e kufizuar me rezistencë të lartë për kryqëzim zero
- vlerësimi i mbrojtjes: IP40
- prerja e tërthortë e telave në terminalin e kontaktit: 0,75 - 2,5 mm²
- zona e zbulimit: deri në 110° në 20°C
- zona e zbulimit: rreth 8 m në 20°C
- rregullimi i kohëzgjatjes: nga rreth 5 sek. deri në 12 min.
- rregullimi i ndriçimit: nga rreth 5 deri në 200 LUX
- temperatura e funksionimit: nga 0°C deri në +40°C
- i papërshtatshëm për instalim në kuti me thellësi 45 mm
- vetëm për përdorim të brendshëm

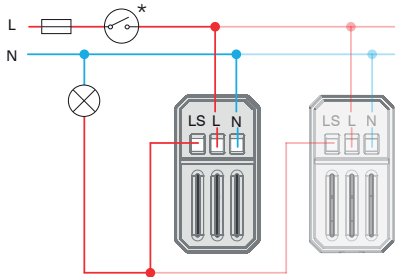

IR SWITCH 5A 230V~

- IR infrared switch
- supply voltage: 230V~ ±10% 50Hz
- relay: 5A / 250V~ output for limited current with high resistance for zero crossing
- protection rating: IP40
- cross-section of wires at the contact terminal: 0.75 - 2.5 mm²
- detection angle: up to 110° at 20°C
- detection area: approx. 8 m at 20°C
- adjustability of duration: from approx. 5 s to 12 min
- adjustability of brightness: from approx. 5 to 200 LUX
- operating temperature: from 0°C to +40°C
- not suitable for installation in 45 mm deep boxes
- only for indoor usage

THERMOSTAT PËR NGROHJE 10 A 230 V~

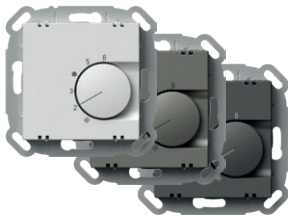

- EQ35PWXO
- EQ35TIXO
- EQ35ATXO

- modaliteti i funksionimit: ngrohje
- furnizimi me energji: 230 V~, 50 Hz
- dalja: 4 A (maks. 10 A), 230 V~, 50 Hz
- kontakti i takim-stakimit: NC (maks. 10 aktivizues)
- gama e rregullimit: +5 °C deri në +30 °C
- histereza: 0,5 K
- mbrojtja: IP30
- lloji i sensorit: dymetalik
- lloji i lidhjes elektrike: kontakte me susta
- lloji i përcuesve: 0,75 – 1,5 mm² (bërthamë me fije fleksibël) ose 1,0 – 2,5 mm² (bërthamë e fortë)

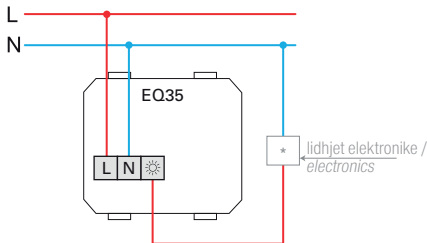

THERMOSTAT HEATING 10A 230V~

- operation mode: heating
- power supply: 230 V~, 50 Hz
- output: 4 A (max. 10 A), 230 V~, 50 Hz
- switching contact: NC (max. 10 actuators)
- regulation range: +5 °C to +30 °C
- hysteresis: 0,5 K
- protection: IP30
- sensor type: bimetal
- type of electrical connection: spring-loaded contacts
- type of conductors: 0,75 – 1,5 mm² (flexible-stranded core) or 1,0 – 2,5 mm² (solid core)

THERMOSTAT PËR NGROHJE/FTOHJE 5 A 230 V~

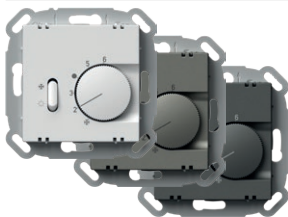

- EQ36PWXO
- EQ36TIXO
- EQ36ATXO

- modaliteti i funksionimit: ngrohje/ftohje
- furnizimi me energji: 230 V~, 50 Hz
- dalja: 2 A (maks. 5 A), 230 V~, 50 Hz
- kontakti i takim-stakimit: komutatori (ndërrues, maks. 5 aktivizues)
- gama e rregullimit: +5 °C deri në +30 °C
- histereza: 0,5 K
- mbrojtja: IP30
- lloji i sensorit: dymetalik
- lloji i lidhjes elektrike: kontakte me susta
- lloji i përcuesve: 0,75 – 1,5 mm² (bërthamë me fije fleksibël) ose 1,0 – 2,5 mm² (bërthamë e fortë)

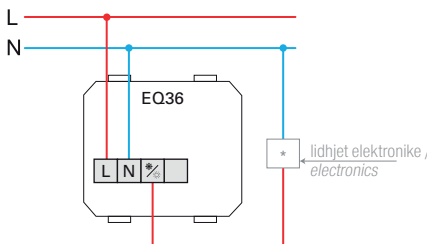

THERMOSTAT HEATING / COOLING 5A 230V~

- operation mode: heating / cooling
- power supply: 230 V~, 50 Hz
- output: 2 A (max. 5 A), 230 V~, 50 Hz
- switching contact: changeover switch (toggler, max. 5 actuators)
- regulation range: +5 °C to +30 °C
- hysteresis: 0,5 K
- protection: IP30
- sensor type: bimetal
- type of electrical connection: spring-loaded contacts
- type of conductors: 0,75 – 1,5 mm² (flexible-stranded core) or 1,0 – 2,5 mm² (solid core)

NGROHJE ME TERMOSTAT NGA DYSHEMEJA 16 A 230 V~

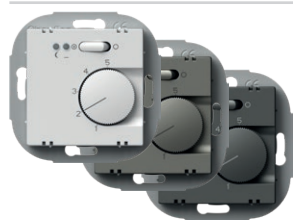

- EQ37PWXO
- EQ37TIXO
- EQ37ATXO

- modaliteti i funksionimit: ngrohje nga dysHEMEJA
- furnizimi me energji: 230 V~, 50 Hz
- dalja: 2 A (maks. 16 A), 230 V~, 50 Hz
- gama e rregullimit: +10 °C deri në +50 °C
- histereza: 1 K
- mbrojtja: IP30
- lloji i sensorit: NTC në përputhje me DIN EN 60730-2-1
- treguesit: LED i kuq për ngrohje dhe LED i gjelbër për modalitetin e uljes së dritës gjatë natës
- lloji i lidhjes elektrike: Kontaktet e vidave
- lloji i përçuesve: 0,5 – 2,5 mm²

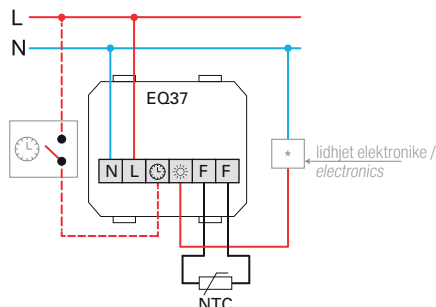

THEMOSTAT FLOOR HEATING 16A 230V~

- operation mode: floor heating
- power supply: 230 V~, 50 Hz
- output: 2 A (max. 16 A), 230 V~, 50 Hz
- regulation range: +10 °C to +50 °C
- hysteresis: 1 K
- protection: IP30
- sensor type: NTC in compliance with DIN EN 60730-2-1
- indicators: Red LED for heating and green LED for night decrease mode
- type of electrical connection: Screw contacts
- type of conductors: 0,5 – 2,5mm²

NJËSI USB E FURNIZIMIT ME ENERGI 5 V 3,0 A



- EQ68PWXO
- EQ68TIXO
- EQ68ATXO

- për karikimin e pajisjeve elektronike përmes një porte standarde USB (e përputhshme gjithashtu me pajisjet Apple)
- furnizimi me energji: 100-230 V~ 50/60 Hz
- konsumi i energjisë: 300 mA në 100 V~/150 mA në 230 V~
- konsumi i energjisë në gatishmëri: 30 mW në 230 V~
- tensioni nominal në dalje: 5 VCD (± 5 %) SELV
- tensioni pulsant në dalje: 150 mV
- rryma nominale në dalje: 3.0 A (±10%)
- lloji i konektorit: USB A/USB C
- efikasiteti: maksimumi 77%
- temperatura e funksionimit: 0 °C/+45 °C (përdorimi i brendshëm)
- klasi i mbrojtjes IP: IP20, vetëm për përdorim në ambiente të brendshme
- klasi i pajisjes II
- kategoria e mbritensionit (EN 62109): Klasi III
- kontaktet e vidave: maks. 2,5 mm²
- pajisje me hapësirë kontakti prej të paktën 3 mm
- në përputhje me standardet EN 60950-1 dhe direktivave LVD dhe EMC



USB POWER SUPPLY UNIT 5V 3.0A

- for charging electronic devices via a standard USB port (also compatible with Apple devices)
- power supply: 100-230V~ 50/60Hz
- power consumption: 300mA at 100V~/150mA at 230V~
- standby power consumption: 30mW at 230V~
- nominal output voltage: 5 VCD (± 5 %) SELV
- output ripple voltage: 150mV
- nominal output current: 3.0 A (±10%)
- connector type: USB A / USB C
- efficiency: maximum of 77%
- operating temperature: 0 °C/+45 °C (indoor use)
- IP protection class: IP20, indoor use only
- class device II
- overvoltage category (EN 62109): Class III
- screw contacts: max. 2.5 mm²
- device with a contact gap of at least 3mm
- in accordance with the EN 60950-1 and LVD & EMC directives

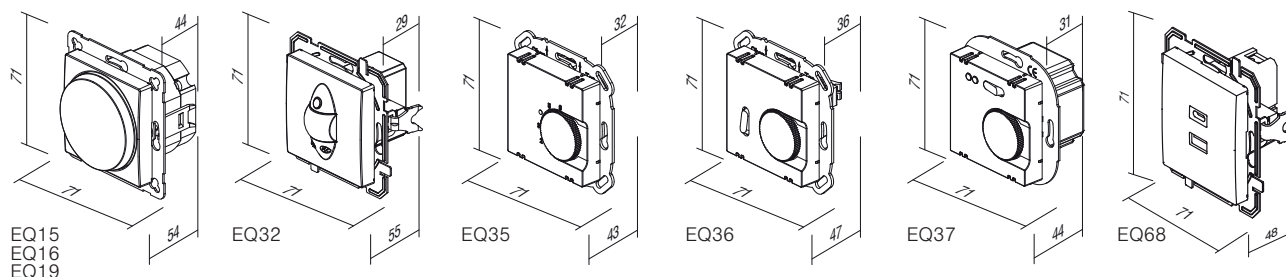

A C C E S S O R I E S P Q

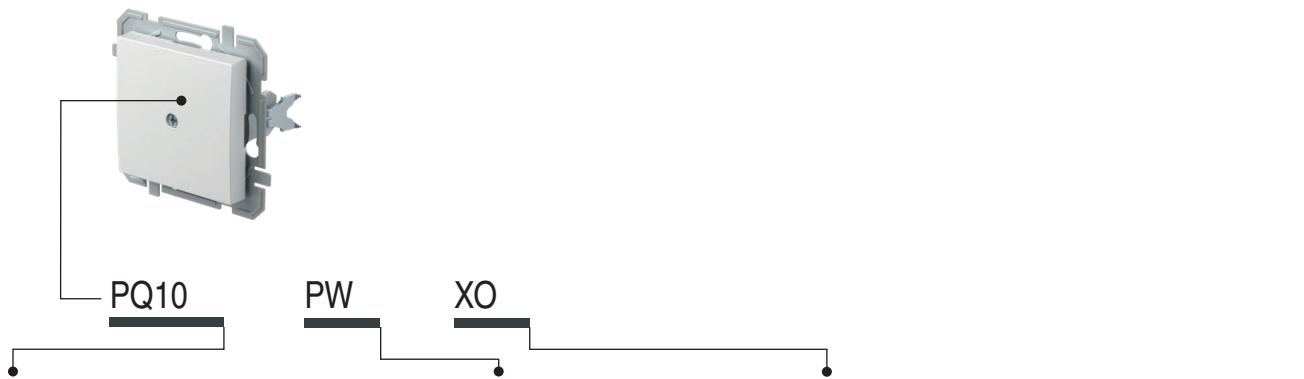

Iloji type	përshkrimi description	ngjyra colour	të dhënat opsionale 1 optional data 1
PQ10	TAPË BLANK	<input type="checkbox"/> PW e bardhë polare polar white	XO pa kapak mbulues without cover plate
PQ30	KAPAK TAE/TDO COVER TAE/TDO	<input type="checkbox"/> TI titan titanium <input type="checkbox"/> AT antracit anthracite	

TAPË



- PQ10PW
- PQ10TI
- PQ10AT

- për mbushjen e hapësirave boshe
BLANK
- for filling up empty spaces



KAPAK TAE/TDO

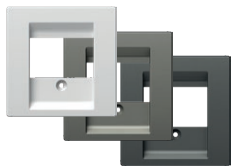

- PQ30PW
- PQ30TI
- PQ30AT

- kapak TAE ose TDO me vidë
COVER TAE/TDO
- TAE or TDO cover with screw

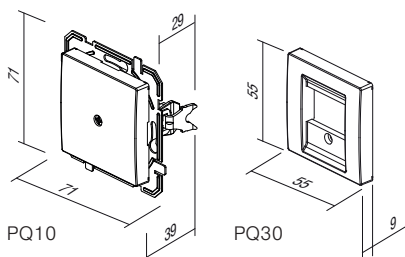



K A P A K Ë T M B U L U E S O Q



OQ10

PW

lloji type	përshkrimi description	ngjyra colour
OQ10	KAPAK MBULUES LOGIQ 1 COVER PLATE LOGIQ 1	 PW e bardhë polare polar white
OQ20	KAPAK MBULUES LOGIQ 2 COVER PLATE LOGIQ 2	 TI titan titanium
OQ30	KAPAK MBULUES LOGIQ 3 COVER PLATE LOGIQ 3	 AT antracit anthracite
:	:	:

KAPAK MBULUES LOGIQ 1



 OQ10PW
 OQ10TI
 OQ10AT

- kapakë mbulues dekorativë me 1 vend
- në përputhje me EN 60669-1

COVER PLATE LOGIQ 1
- decorative cover plate 1-gang
- in accordance with EN 60669-1

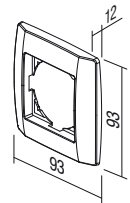

KAPAK MBULUES LOGIQ 2



 OQ20PW
 OQ20TI
 OQ20AT

- kapak mbulues dekorativ me 2 vende
- në përputhje me EN 60669-1

COVER PLATE LOGIQ 2
- decorative cover plate 2-gang
- in accordance with EN 60669-1

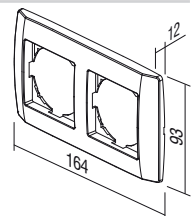



OQ30PW
 OQ30TI
 OQ30AT

KAPAK MBULUES LOGIQ 3

- kapak mbulues dekorativ me 3 vende
 - në përputhje me EN 60669-1

COVER PLATE LOGIQ 3

- decorative cover plate 3-gang
 - in accordance with EN 60669-1

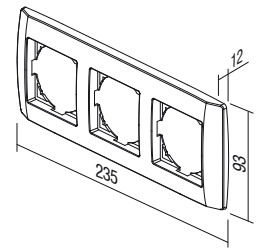

OQ40PW
 OQ40TI
 OQ40AT

KAPAK MBULUES LOGIQ 4

- kapak mbulues dekorativ me 4 vende
 - në përputhje me EN 60669-1

COVER PLATE LOGIQ 4

- decorative cover plate 4-gang
 - in accordance with EN 60669-1

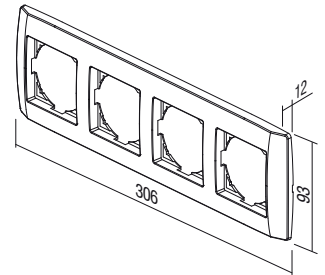

OQ50PW
 OQ50TI
 OQ50AT

KAPAK MBULUES LOGIQ 5

- kapak mbulues dekorativ me 5 vende
 - në përputhje me EN 60669-1

COVER PLATE LOGIQ 5

- decorative cover plate 5-gang
 - in accordance with EN 60669-1

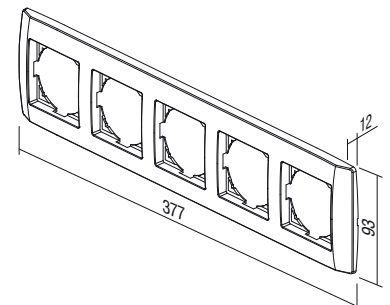

TEM

ekonomik





ekonomik

PLANIFIKUAR PËR PËRSOSMËRI **Stili është thelbësor**

Një dizajn neutral, kompakt dhe elegant mund të përshtatet me çdo ambient pune ose banimi. Nuk dallon nga ambienti i brendshëm, por në të kundërt përshtatet me të në mënyrë harmonike.

PLANNED FOR EXCELLENCE Style is essential

A neutral, compact, elegant design is adjustable to every working or living area. It does not stick out from the interior, but rather harmonically fits into it.





ekonomik

HARMONIA E NGJYRAVE Zgjidhni nuancën tuaj

Dëshirat mund të jenë shumë të ndryshme. Prandaj, ne kemi zgjedhur me kujdes mundësitë për ju, që mund t'ju ofrojnë përgjigjen e duhur. Një paletë neutrale ngjyrash vetëm thjesht do ta plotësojë ambientin tuaj - nuk do ta kufizojë atë.

HARMONY OF COLOURS Choose your hue

Desires can be very different. Therefore we have carefully selected possibilities for you, which can offer you the right answer. A neutral palette of colours will only complement your ambient - it will not restrict it.

- | | | |
|-----------------------------|-------------------------------|------------------------|
| <input type="checkbox"/> PW | e bardhë polare | <i>polar white</i> |
| <input type="checkbox"/> IW | e bardhë fildishi | <i>ivory white</i> |
| <input type="checkbox"/> ES | e argjendë elox | <i>elox silver</i> |
| <input type="checkbox"/> CO | e bardhë termoplastike | <i>white thermoset</i> |
| <input type="checkbox"/> NB | e zezë mesnate | <i>night black</i> |



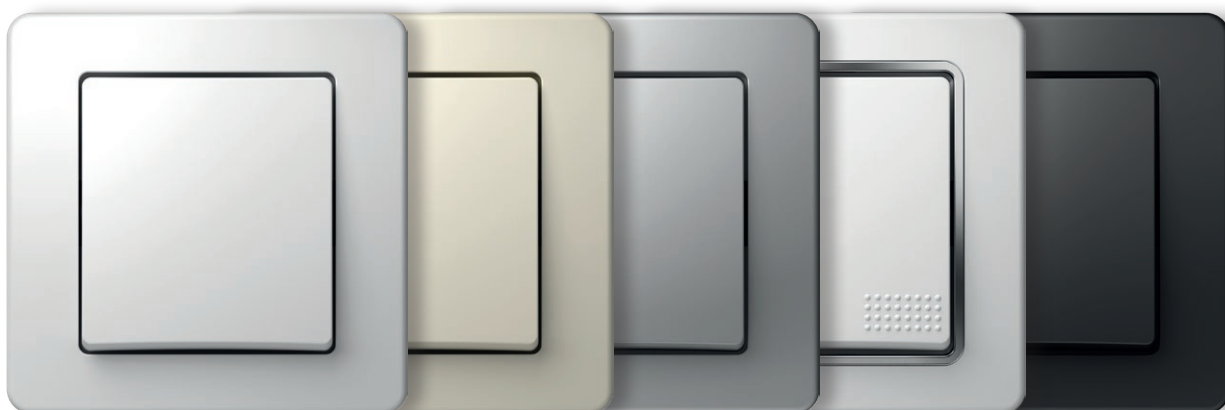

TË THJESHTË EDHE PËR PERSONAT MË KËRKUES

Nëpërmjet planifikimit të kujdesshëm, elementet nën tension janë të mbrojtura ndaj prekjes. Fiksimi bazë i mekanizmave me kapëse fiksuese (1) lejon përforcim shtesë me vida (2). Kjo mënyrë është veçanërisht e përshtatshme për fiksimin e sigurt dhe të qëndrueshëm të prizave.

SIMPLE FOR THE MOST DEMANDING

By careful planning elements under voltage have been protected against touching. Basic fixing of mechanisms with fixing claws (1) allows additional strengthening with screws (2). This manner is especially appropriate for safe and reliable fixing of sockets.

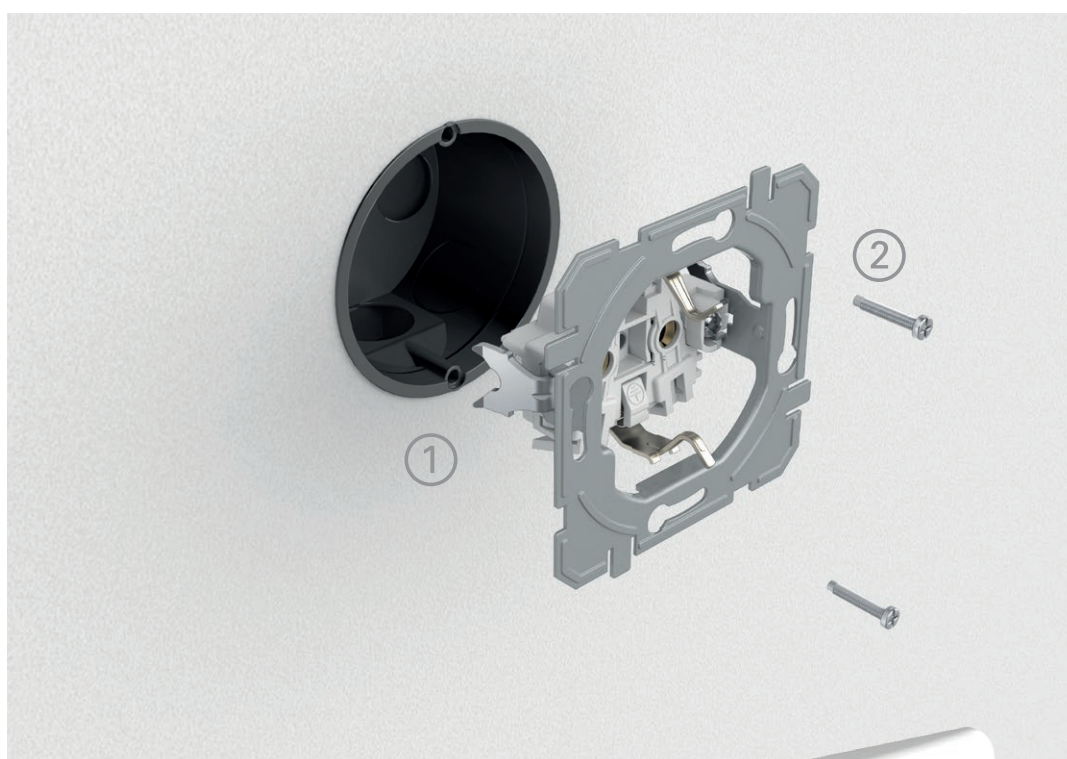

KOMBINONI SIPAS DËSHIRËS.

COMBINE AS YOU PLEASE.



Duke kombinuar, ju kurseni hapësirë në mur.
Kur përballeni me një hapësirë të kufizuar,
“vertikalisht” është vendimi më i mirë.

With combining you save space on the wall.
When faced with a limited space, »vertically«
is the right decision.

INSTALIM I LEHTË

Ekonomik është një zgjidhje për sistemin e kutive të standardizuara të rrumbullakëta të instalimit. Ai mund të përdoret për instalime të thjeshta, si dhe të komplikuar, ndërtesa të reja dhe përshtatje. Sistemi karakterizohet nga kontakte për futje telash që kursejnë kohë gjatë instalimit të elementeve.

EASY INSTALLATION

Ekonomik is a solution for the system of standardized round installations boxes. It can be used for simple as well as more demanding installations, new buildings and adaptations. The system is characterised by plug-in contacts which save time during installation of elements.

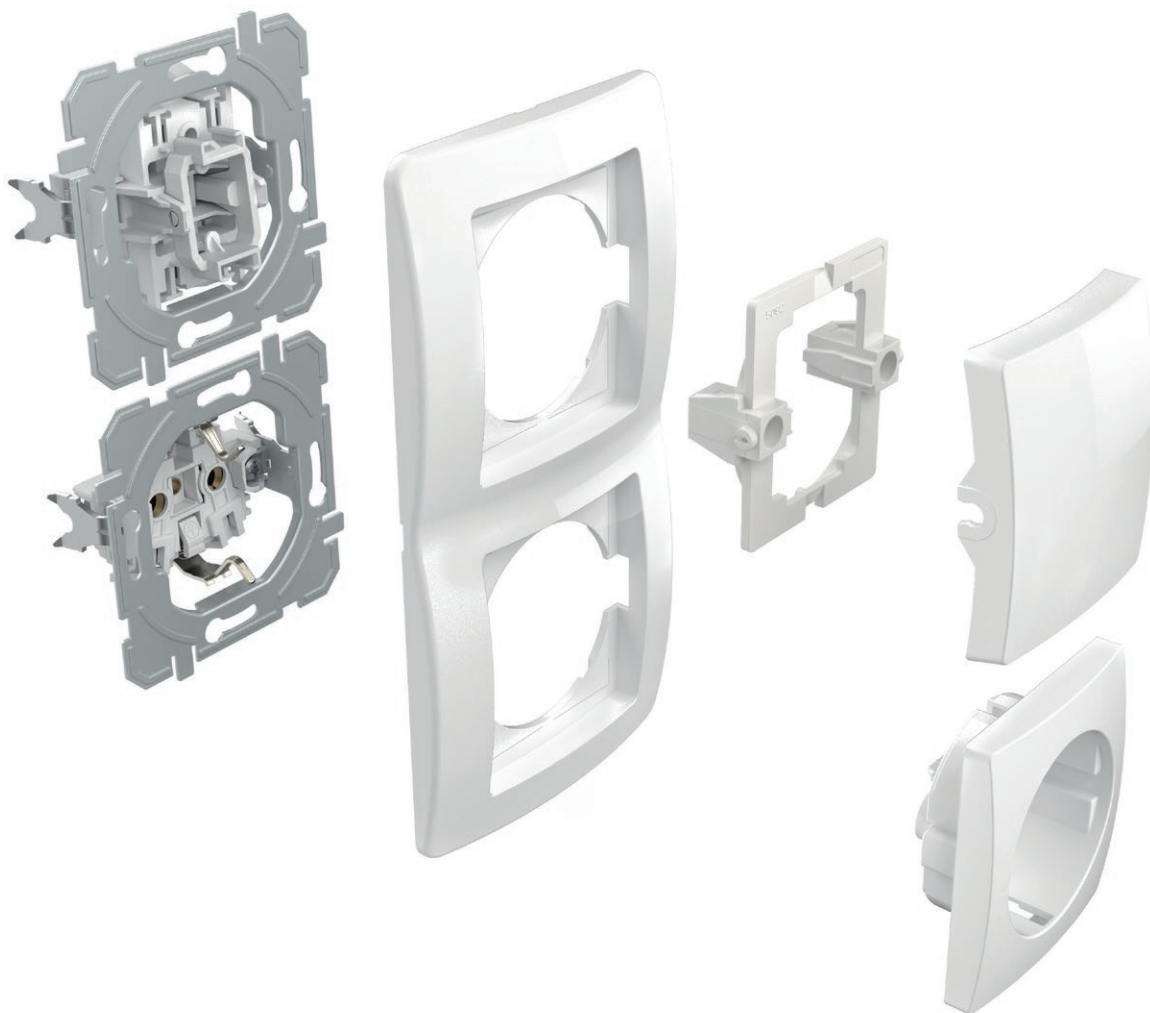

INFORMACION I DOBISHËM

GOOD TO KNOW



Të gjitha prizat janë të pajisura me mbyllëse sigurie që garantojnë mbrojtjen e kontakteve nën tension.

All the sockets are equipped with a safety shutters assuring the protection to live contacts.



Dizajni i mirëmenduar i çelësit mundëson integrimin e thjeshtë të treguesit, edhe në një moment të mëvonshëm.

The well-thought-out design of the switch enables the easy integration of the indication, including at a later time.



Kontaktet prej aliazhi argjendi garantojnë komutimin e sigurt.

Contacts made of silver alloy guarantee safe switching.



Kontaktet për futjen e telave mundësojnë bashkim të shpejtë dhe të sigurt të telave. Dy tela me diametër të ndryshëm mund të bashkohen me të njëjtin kontakt.

Plug-in contacts enable quick and reliable attachment of wires. Two wires of different diameters can be attached to the same contact.



Kapëset fiksuese mundësojnë fiksime më të thellë (gjithashtu përmes pllakave qeramike etj.)







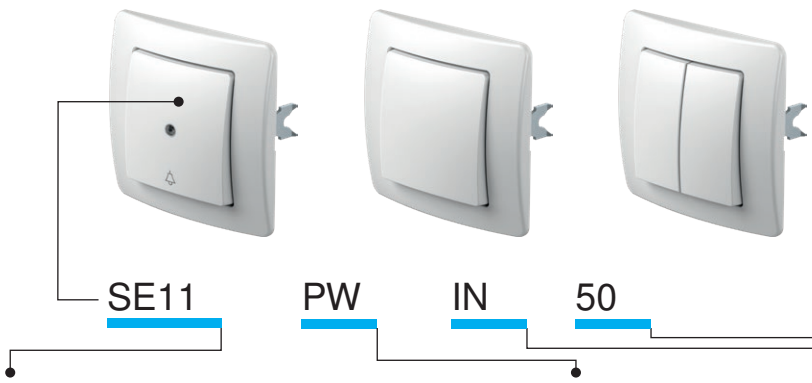

Fixing claws enable deeper fixing (also through ceramic tiles, etc.)



Kutitë e instalimit me montim të lehtë do t'ju lehtësojnë punën. Gjatësitë e dhura janë të garantuara.

Easy-fitting installation boxes will make your work easier. Proper lengths are guaranteed.



Iloji type	përshkrimi description	të dhënat teknike technical data	ngjyra colour	të dhënat opsionale 1 optional data 1	të dhënat opsionale 2 optional data 2
SE10	ÇELËS ME 1 DREJTIM SWITCH 1WAY	10AX 250V~	<input type="checkbox"/> PW e bardhë polare polar white	 NT neutral neutral	 50
SE11	BUTON MESHTYRJE ME 1 DREJTIM PUSH BUTTON 1WAY	10A 250V~	<input type="checkbox"/> IW e bardhë fildishi ivory white		 51
SE22	ÇELËS 2 POLAR SWITCH 2POLE	16AX 250V~	<input type="checkbox"/> ES e argjendtë elox elox silver	 IN treguesi indicator	 03
...	<input type="checkbox"/> CO termoset i bardhë white thermostat		 04
...	<input type="checkbox"/> NB e zezë mesnate night black		 04

ÇELËS ME 1 DREJTIM 10 A X 250 V~

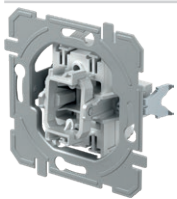

SE10

- 10 A X 250 V~, Iloji SE10
 - në përputhje me EN 60669-1
 - kontakte për futje telash 1,5-2,5 mm²
- SWITCH 1WAY 10AX 250V~
- 10AX 250V~, type SE10
 - in accordance with EN 60669-1
 - plug-in contacts 1.5-2.5mm²

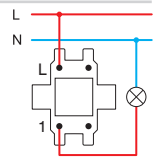

BUTON ME SHTYRJE ME 1 DREJTIM 10A 250 V~

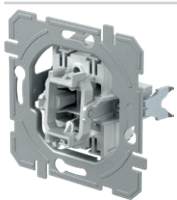

SE11

- 10A 250 V~, Iloji SE11
 - në përputhje me EN 60669-1
 - kontakte për futje telash 1,5-2,5 mm²
- PUSH BUTTON 1WAY 10A 250V~
- 10A 250V~, type SE11
 - in accordance with EN 60669-1
 - plug-in contacts 1.5-2.5mm²

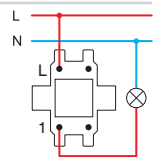

ÇELËS 2 POLAR 16 A X 250 V~

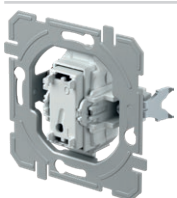

SE22

- 16 A X 250 V~, Iloji SE22
 - në përputhje me EN 60669-1
 - kontaktet e vidave 1,5-2,5 mm²
 - vetëm në kombinim me butonin TE10__NT03
- SWITCH 2POLE 16AX 250V~
- 16AX 250V~, type SE22
 - in accordance with EN 60669-1
 - screw contacts 1.5-2.5mm²
 - only in combination with button TE10__NT03

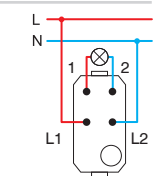
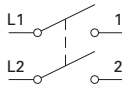

ÇELËS ME 2 POZICIONE - 1 DREJTIM 10 A X 250 V~

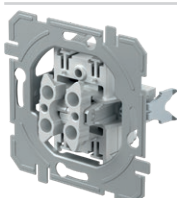

SE50

- 10 A X 250 V~, Iloji SE50
 - në përputhje me EN 60669-1
 - kontakte për futje telash 1,5-2,5 mm²
- SWITCH 2GANG-1WAY 10AX 250V~
- 10AX 250V~, type SE50
 - in accordance with EN 60669-1
 - plug-in contacts 1.5-2.5mm²

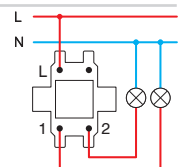
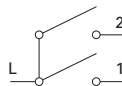

S W I T C H E S S E

BUTON ME SHYTPJE ME 2 POZICIONE - 1 DREJTIM 10A 250 V~

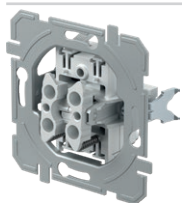

SE51

- 10 A 250 V~, Iloji SE51
- në përputhje me EN 60669-1
- kontakte për futje telash 1,5-2,5 mm²

PUSH BUTTON 2GANG-1WAY 10A 250V~

- 10A 250V~, type SE51
- in accordance with EN 60669-1
- plug-in contacts 1.5-2.5mm²

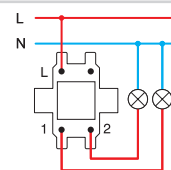
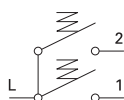

MBYLLËSE ÇELËSI 10 A X 250 V~

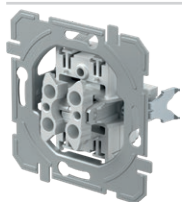

SE52

- 10 A X 250 V~, Iloji SE52
- në përputhje me EN 60669-1
- kontakte për futje telash 1,5-2,5 mm²
- me bllokim mekanik

SWITCH SHUTTERS 10AX 250V~

- 10AX 250V~, type SE52
- in accordance with EN 60669-1
- plug-in contacts 1.5-2.5mm²
- with mechanical interblock

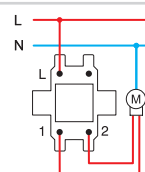
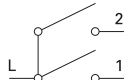

MBYLLËSE BUTONI ME SHYTPJE 10 A 250 V~

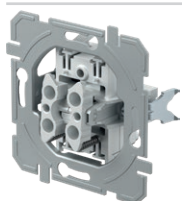

SE53

- 10A 250 V~, Iloji SE53
- në përputhje me EN 60669-1
- kontakte për futje telash 1,5-2,5 mm²
- me bllokim mekanik

PUSH BUTTON SHUTTERS 10A 250V~

- 10A 250V~, type SE53
- in accordance with EN 60669-1
- plug-in contacts 1.5-2.5mm²
- with mechanical interblock

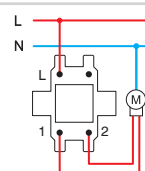
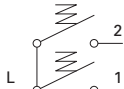

ÇELËS ME 2 DREJTIME 10 A X 250 V~

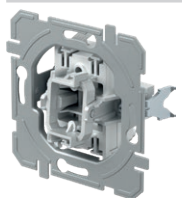

SE60

- 10 A X 250 V~, Iloji SE60
- në përputhje me EN 60669-1
- kontakte për futje telash 1,5-2,5 mm²

SWITCH 2WAY 10AX 250V~

- 10AX 250V~, type SE60
- in accordance with EN 60669-1
- plug-in contacts 1.5-2.5mm²

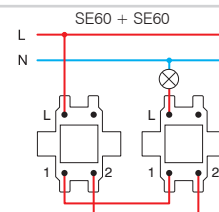
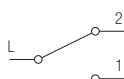

ÇELËS DYSH ME 2 DREJTIME 10 A X 250 V~

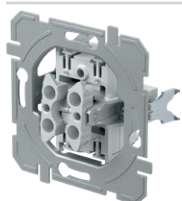

SE63

- 10 A X 250 V~, Iloji SE63
- në përputhje me EN 60669-1
- kontakte për futje telash 1,5-2,5 mm²

SWITCH DOUBLE 2WAY 10AX 250V~

- 10AX 250V~, type SE63
- in accordance with EN 60669-1
- plug-in contacts 1.5-2.5mm²

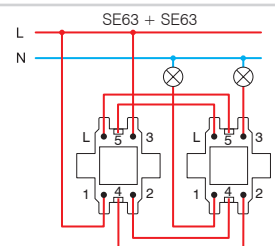

ÇELËS NDËRMJETËS 10 A X 250 V~

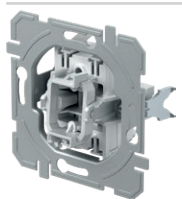

SE70

- 10 A X 250 V~, Iloji SE70
- në përputhje me EN 60669-1
- kontakte për futje telash 1,5-2,5 mm²

SWITCH INTERMEDIATE 10AX 250V~

- 10AX 250V~, type SE70
- in accordance with EN 60669-1
- plug-in contacts 1.5-2.5mm²

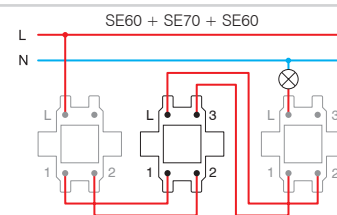

ÇELËS ME 1 DREJTIM 10 A X 250 V~



- SE10PW
- SE10IW
- SE10ES
- SE10CO
- SE10NB

- 10 A X 250 V~, Iloji SE10
 - në përputhje me EN 60669-1
 - kontakte për futje telash 1,5-2,5 mm²

SWITCH 1WAY 10AX 250V~
 - 10AX 250V~, type SE10
 - in accordance with EN 60669-1
 - plug-in contacts 1.5-2.5mm²



ÇELËS ME 1 DREJTIM 10 A X 250 V~ __ IN



- SE10PWIN
- SE10IWIN
- SE10ESIN
- SE10COIN
- SE10NBIN

- IN tregues
 - 10 A X 250 V~, Iloji SE10
 - në përputhje me EN 60669-1
 - kontakte për futje telash 1,5-2,5 mm²

SWITCH 1WAY 10AX 250V~ __ IN
 - IN indicator
 - 10AX 250V~, type SE10
 - in accordance with EN 60669-1
 - plug-in contacts 1.5-2.5mm²



BUTON ME SHTYPJE ME 1 DREJTIM 10A 250 V~



- SE11PW
- SE11IW
- SE11ES
- SE11CO
- SE11NB

- 10A 250 V~, Iloji SE11
 - në përputhje me EN 60669-1
 - kontakte për futje telash 1,5-2,5 mm²

PUSH BUTTON 1WAY 10A 250V~
 - 10A 250V~, type SE11
 - in accordance with EN 60669-1
 - plug-in contacts 1.5-2.5mm²



BUTON ME SHTYPJE ME 1 DREJTIM 10 A 250 V~ __ TI 50



- SE11PWTI50
- SE11IWTI50
- SE11ESTI50
- SE11COTI50
- SE11NBTI50

- TI 50 zile treguese+llambë neoni
 - 10A 250 V~, Iloji SE11
 - në përputhje me EN 60669-1
 - kontakte për futje telash 1,5-2,5 mm²

PUSH BUTTON 1WAY 10A 250V~ __ TI 50
 - TI 50 indicator bell+neon lamp
 - 10A 250V~, type SE11
 - in accordance with EN 60669-1
 - plug-in contacts 1.5-2.5mm²



BUTON ME SHTYPJE ME 1 DREJTIM 10 A 250 V~ __ TI 51



- SE11PWTI51
- SE11IWTI51
- SE11ESTI51
- SE11COTI51
- SE11NBTI51

- TI 51 dritë treguese+llambë neoni
 - 10A 250 V~, Iloji SE11
 - në përputhje me EN 60669-1
 - kontakte për futje telash 1,5-2,5 mm²

PUSH BUTTON 1WAY 10A 250V~ __ TI 51
 - TI 51 indicator light+neon lamp
 - 10A 250V~, type SE11
 - in accordance with EN 60669-1
 - plug-in contacts 1.5-2.5mm²



BUTON ME SHTYPJE ME 1 DREJTIM 10 A 250 V~ __ IL



- SE11PWIL
- SE11IWIL
- SE11ESIL
- SE11COIL
- SE11NBIL

- IL pllakë me mbishkrim
 - 10A 250 V~, Iloji SE11
 - në përputhje me EN 60669-1
 - kontakte për futje telash 1,5-2,5 mm²

PUSH BUTTON 1WAY 10A 250V~ __ IL
 - IL inscription plate
 - 10A 250V~, type SE11
 - in accordance with EN 60669-1
 - plug-in contacts 1.5-2.5mm²



ÇELËS 2 POLAR 16 A X 250 V~ __ IN 03



- SE22PWIN03
- SE22IWIN03
- SE22ESIN03
- SE22NBIN03

- IN 03 neutral 0-1
 - 16 A X 250 V~, Iloji SE22
 - në përputhje me EN 60669-1
 - kontaktet e vidave 1,5-2,5 mm²

SWITCH 2POLE 16AX 250V~ __ IN 03
 - IN 03 neutral 0-1
 - 16AX 250V~, type SE22
 - in accordance with EN 60669-1
 - screw contacts 1.5-2.5mm²



	<ul style="list-style-type: none"> <input type="checkbox"/> SE50PW <input type="checkbox"/> SE50IW <input type="checkbox"/> SE50ES <input type="checkbox"/> SE50CO <input type="checkbox"/> SE50NB 	ÇELËS ME 2 POZICIONE - 1 DREJTIM 10 A X 250 V~	<ul style="list-style-type: none"> - 10 A X 250 V~, Iloji SE50 - në përputhje me EN 60669-1 - kontakte për futje telash 1,5-2,5 mm² <p><i>SWITCH 2GANG-1WAY 10AX 250V~</i></p> <ul style="list-style-type: none"> - 10AX 250V~, type SE50 - in accordance with EN 60669-1 - plug-in contacts 1.5-2.5mm² 	
	<ul style="list-style-type: none"> <input type="checkbox"/> SE51PW <input type="checkbox"/> SE51IW <input type="checkbox"/> SE51ES <input type="checkbox"/> SE51CO <input type="checkbox"/> SE51NB 	BUTON ME SHTYPJE ME 2 POZICIONE - 1 DREJTIM 10A 250 V~	<ul style="list-style-type: none"> - 10 A 250 V~, Iloji SE51 - në përputhje me EN 60669-1 - kontakte për futje telash 1,5-2,5 mm² <p><i>PUSH BUTTON 2GANG-1WAY 10A 250V~</i></p> <ul style="list-style-type: none"> - 10A 250V~, type SE51 - in accordance with EN 60669-1 - plug-in contacts 1.5-2.5mm² 	
	<ul style="list-style-type: none"> <input type="checkbox"/> SE52PWNT09 <input type="checkbox"/> SE52IWNT09 <input type="checkbox"/> SE52ESNT09 <input type="checkbox"/> SE52CONT09 <input type="checkbox"/> SE52NBNT09 	MBYLLËSE ÇELËSI 10 A X 250 V~ __ NT 09	<ul style="list-style-type: none"> - NT 09 neutral lart-poshtë - 10 A X 250 V~, Iloji SE52 - në përputhje me EN 60669-1 - kontakte për futje telash 1,5-2,5 mm² - me bllokim mekanik <p><i>SWITCH SHUTTERS 10AX 250V~ __ NT 09</i></p> <ul style="list-style-type: none"> - NT 09 neutral up-down - 10AX 250V~, type SE52 - in accordance with EN 60669-1 - plug-in contacts 1.5-2.5mm² - with mechanical interblock 	
	<ul style="list-style-type: none"> <input type="checkbox"/> SE53PWNT09 <input type="checkbox"/> SE53IWNT09 <input type="checkbox"/> SE53ESNT09 <input type="checkbox"/> SE53CONT09 <input type="checkbox"/> SE53NBNT09 	MBYLLËSE BUTONI ME SHTYPJE 10 A 250 V~ __ NT 09	<ul style="list-style-type: none"> - NT 09 neutral lart-poshtë - 10A 250 V~, Iloji SE53 - në përputhje me EN 60669-1 - kontakte për futje telash 1,5-2,5 mm² - me bllokim mekanik <p><i>PUSH BUTTON SHUTTERS 10A 250V~ __ NT 09</i></p> <ul style="list-style-type: none"> - NT 09 neutral up-down - 10A 250V~, type SE53 - in accordance with EN 60669-1 - plug-in contacts 1.5-2.5mm² - with mechanical interblock 	
	<ul style="list-style-type: none"> <input type="checkbox"/> SE60PW <input type="checkbox"/> SE60IW <input type="checkbox"/> SE60ES <input type="checkbox"/> SE60CO <input type="checkbox"/> SE60NB 	ÇELËS ME 2 DREJTIME 10 A X 250 V~	<ul style="list-style-type: none"> - 10 A X 250 V~, Iloji SE60 - në përputhje me EN 60669-1 - kontakte për futje telash 1,5-2,5 mm² <p><i>SWITCH 2WAY 10AX 250V~</i></p> <ul style="list-style-type: none"> - 10AX 250V~, type SE60 - in accordance with EN 60669-1 - plug-in contacts 1.5-2.5mm² 	
	<ul style="list-style-type: none"> <input type="checkbox"/> SE63PW <input type="checkbox"/> SE63IW <input type="checkbox"/> SE63ES <input type="checkbox"/> SE63CO <input type="checkbox"/> SE63NB 	ÇELËS DYSH ME 2 DREJTIME 10 A X 250 V~	<ul style="list-style-type: none"> - 10 A X 250 V~, Iloji SE63 - në përputhje me EN 60669-1 - kontakte për futje telash 1,5-2,5 mm² <p><i>SWITCH DOUBLE 2WAY 10AX 250V~</i></p> <ul style="list-style-type: none"> - 10AX 250V~, type SE63 - in accordance with EN 60669-1 - plug-in contacts 1.5-2.5mm² 	
	<ul style="list-style-type: none"> <input type="checkbox"/> SE70PW <input type="checkbox"/> SE70IW <input type="checkbox"/> SE70ES <input type="checkbox"/> SE70CO <input type="checkbox"/> SE70NB 	ÇELËS NDËRMJETËS 10 A X 250 V~	<ul style="list-style-type: none"> - 10 A X 250 V~, Iloji SE70 - në përputhje me EN 60669-1 - kontakte për futje telash 1,5-2,5 mm² <p><i>SWITCH INTERMEDIATE 10AX 250V~</i></p> <ul style="list-style-type: none"> - 10AX 250V~, type SE70 - in accordance with EN 60669-1 - plug-in contacts 1.5-2.5mm² 	

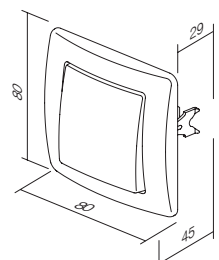
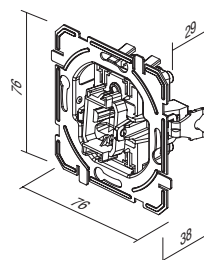

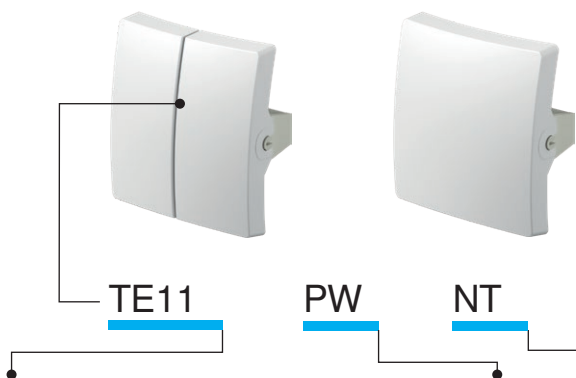

Iloji type	përshkrimi description	ngjyra colour	të dhënat opsionale 1 optional data 1	të dhënat opsionale 2 optional data 2
TE10	BUTON ME 1 POZICION BUTTON 1GANG	<input type="checkbox"/> PW e bardhë polare polar white	NT neutral neutral	50
TE11	BUTON ME 2 POZICIONE BUTTON 2GANG	<input type="checkbox"/> IW e bardhë fildishi ivory white	IN treguesi indicator	51
...	...	<input type="checkbox"/> ES e argjendtë elox elox silver		03
...	...	<input type="checkbox"/> CO termoset i bardhë white thermoset		04
...	...	<input type="checkbox"/> NB e zezë mesnate night black		...

BUTON ME 1 POZICION



- TE10PW
- TE10IW
- TE10ES
- TE10CO
- TE10NB

- buton bashkë me mbajtësen

BUTTON 1GANG

- button together with carrier



TREGUES BUTONI

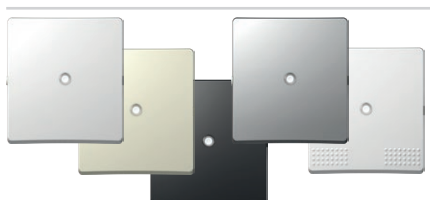

- TE10PWIN
- TE10IWIN
- TE10ESIN
- TE10COIN
- TE10NBIN

- buton bashkë me mbajtësen

BUTTON INDICATOR

- button together with carrier



BUTON ME KAPAK ME MBISHKRIM

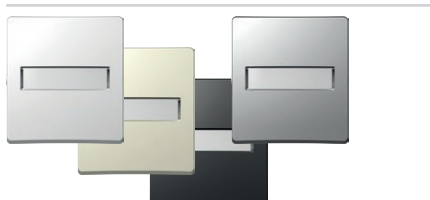

- TE13PWIL
- TE13IWIL
- TE13ESIL
- TE13NBIL

- buton bashkë me mbajtësen, me pllakë me mbishkrim

BUTTON WITH INSCRIPTION PLATE

- button together with carrier, with inscription plate



BUTON ME 2 POZICIONE



- TE11PW
- TE11IW
- TE11ES
- TE11CO
- TE11NB

- butoni me 2 pozicione bashkë me mbajtësen

BUTTON 2GANG

- button 2gang together with carrier

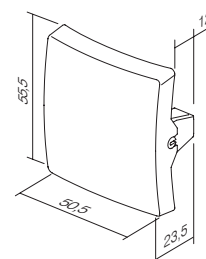
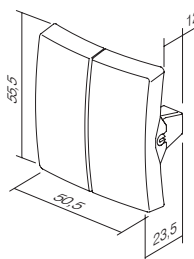

S I G N A L I Z A T I O N I A

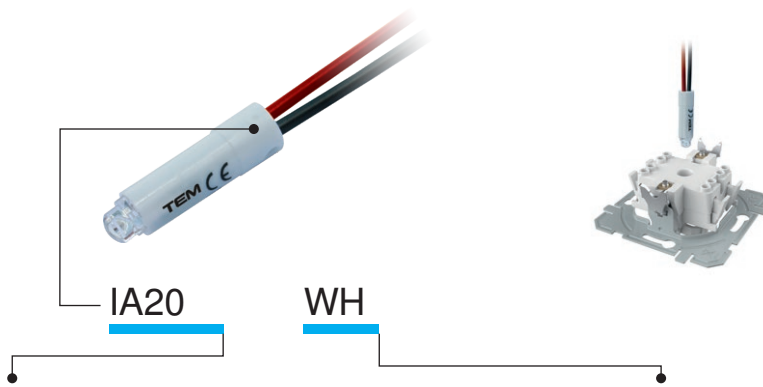

Iloji type	përshkrimi description	të dhënat teknike technical data	ngjyra colour
IA10	LLAMBË NEONI NEON LAMP	230V~ 0,34W	<input type="checkbox"/> WH e bardhë white
IA20	LLAMBË LED LED SIGNALLING UNIT	230V~ 0,40W	<input checked="" type="checkbox"/> BL blu blue
IA21	LLAMBË LED LED SIGNALLING UNIT	24V AC/DC 0,20W	<input checked="" type="checkbox"/> RD e kuqe red
⋮	⋮	⋮	<input checked="" type="checkbox"/> GR e gjelbër green
⋮	⋮	⋮	<input checked="" type="checkbox"/> OR portokalli orange

LLAMBË NEONI 230 V~ 0,34 W



 IA10OR

- për indikim, sinjalizim ose sinjalizim të përhershëm
- në kombinim me një buton që ka një tregues

NEON LAMP 230V~ 0,34W

- for indication, signalling or permanent signalling
- in combination with a button featuring an indicator

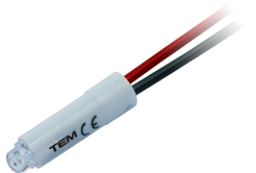
SINJALIZIMI LED 230 V AC/DC 0,40 W



 IA20WH
 IA20GR
 IA20RD
 IA20BL

- për indikim, sinjalizim ose sinjalizim të përhershëm
- në kombinim me një buton që ka një tregues

LED SIGNALLING UNIT 230V AC/DC 0,40W

- for indication, signalling or permanent signalling
- in combination with a button featuring an indicator

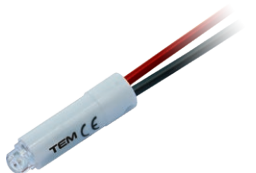
SINJALIZIMI LED 24V AC/DC 0,20W

 IA21WH
 IA21RD

- për indikim, sinjalizim ose sinjalizim të përhershëm
- në kombinim me një buton që ka një tregues

LED SIGNALLING UNIT 24V AC/DC 0,20W

- for indication, signalling or permanent signalling
- in combination with a button featuring an indicator

SINJALIZIMI LED 12V AC/DC 0,10W

 IA22WH
 IA22RD

- për indikim, sinjalizim ose sinjalizim të përhershëm
- në kombinim me një buton që ka një tregues

LED SIGNALLING UNIT 12V AC/DC 0,10W

- for indication, signalling or permanent signalling
- in combination with a button featuring an indicator

Treguesi /
Indication

* Sinjalizimi /
Signalization

Sinjalizimi i përhershëm /
Permanent signalling

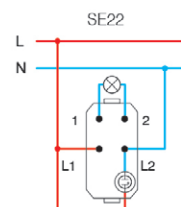
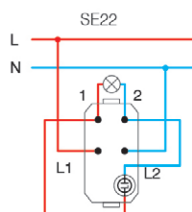
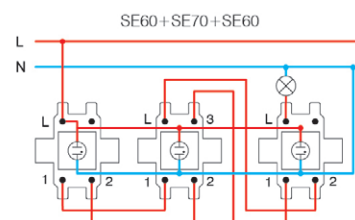
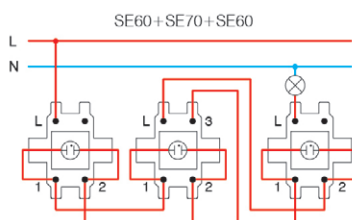
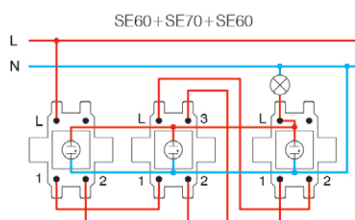
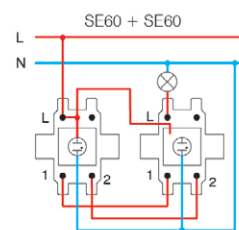
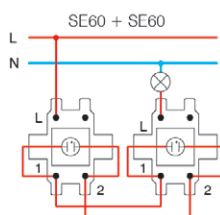
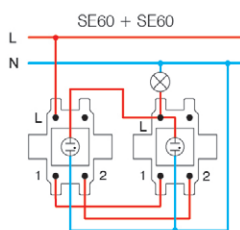
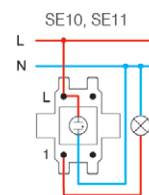
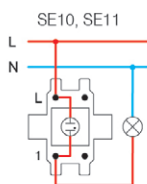
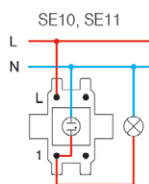

* lidhjet nuk janë të përshtatshme për llambat që kursejnë energji (CFL, LED) /
the connections are not suitable for energy-saving bulbs (CFL, LED)

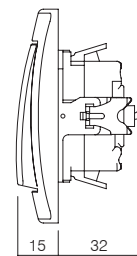

S O C K E T S V E

VE11 **PT** **XO** **KS**

lloji type	përshkrimi description	të dhënat teknike technical data	të dhënat opsionale 1 optional data 1	të dhënat opsionale 2 optional data 2
VE10	PRIZË SCHUKO SOCKET SCHUKO	2P+E 16A 250V~	XO pa kapak mbulues without cover plate	KS kontaktet me rrymën të mbuluara shuttered live contacts
VE11	PRIZË SCHUKO+KAPAK SOCKET SCHUKO+COVER	2P+E 16A 250V~		
VE12	PRIZË SCHUKO SOCKET SCHUKO	2P+E 16A 250V~ BV	KS kontaktet me rrymën të mbuluara shuttered live contacts	
⋮	⋮	⋮		

ngjyra
colour

<input type="checkbox"/> PW e bardhë polare polar white	<input checked="" type="checkbox"/> PT e bardhë+transparente white+transparent	<input type="checkbox"/> PP e bardhë+e bardhë white+white
<input checked="" type="checkbox"/> IW e bardhë fildishi ivory white	<input checked="" type="checkbox"/> IT e fildishtë+transparente ivory+transparent	<input checked="" type="checkbox"/> II e fildishtë+e fildishtë ivory+ivory
<input type="checkbox"/> ES e argjendtë elox elox silver	<input checked="" type="checkbox"/> ST e argjendtë+transparente silver+transparent	<input type="checkbox"/> SS e argjendtë+e argjendtë silver+silver
<input type="checkbox"/> CO termoset i bardhë white thermoset	<input type="checkbox"/> CT e bardhë+transparente white+transparent	<input checked="" type="checkbox"/> BB e zezë+e zezë black+black
<input checked="" type="checkbox"/> NB e zezë mesnate night black	<input checked="" type="checkbox"/> BT e zezë+transparente black+transparent	<input checked="" type="checkbox"/> RR e kuqe+e kuqe red+red
<input checked="" type="checkbox"/> RD e kuqe red	<input checked="" type="checkbox"/> RT e kuqe+transparente red+transparent	<input checked="" type="checkbox"/> GG e gjelbër+e gjelbër green+green
<input checked="" type="checkbox"/> GR e gjelbër green	<input checked="" type="checkbox"/> GT e gjelbër+transparente green+transparent	<input checked="" type="checkbox"/> OO portokalli+portokalli orange+orange
<input checked="" type="checkbox"/> OR portokalli orange	<input checked="" type="checkbox"/> OT portokalli+transparente orange+transparent	



schuko - në përputhje me EN 60884-1, CEE7 (fleta e standardit III)

Franceze - në përputhje me NF C 61-314 (fleta e standardit V)

schuko - in accordance with EN 60884-1, CEE7 (standard sheet III)

French - in accordance with NF C 61-314 (standard sheet V)

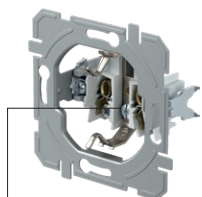

• kontaktet e vidave
screw contacts

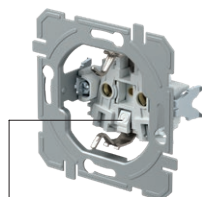

• kontaktet për futje telash BV
BV plug-in contacts

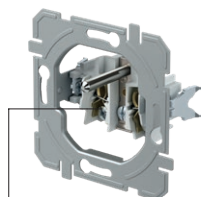

• kontaktet e vidave
screw contacts

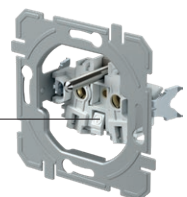

• kontaktet për futje telash BV
BV plug-in contacts

PRIZË SCHUKO 2P+E 16 A 250 V~ __ XO

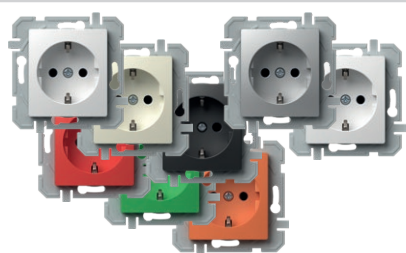

- VE10PWXO
- VE10IWXO
- VE10ESXO
- VE10COXO
- VE10NBXO
- VE10RDXO
- VE10GRXO
- VE10ORXO

- kontaktet e vidave 1,5-2,5 mm²
- XO pa kapak mbulues
- 2P+E schuko
- 16 A 250 V~, Iloji VE10

SOCKET SCHUKO 2P+E 16A 250V~ __ XO

- screw contacts 1.5-2.5mm²
- XO without surround
- 2P+E schuko
- 16A 250V~, type VE10



PRIZË SCHUKO+KAPAK 2P+E 16 A 250 V~ __ XO

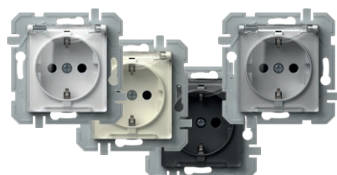

- VE11PTXO
- VE11ITXO
- VE11STXO
- VE11BTXO

- kontaktet e vidave 1,5-2,5 mm²
- XO pa kapak mbulues
- 2P+E schuko+kapak
- 16 A 250 V~, Iloji VE11

SOCKET SCHUKO+COVER 2P+E 16A 250V~ __ XO

- screw contacts 1.5-2.5mm²
- XO without surround
- 2P+E schuko+cover
- 16A 250V~, type VE11



PRIZË SCHUKO 2P+E 16 A 250 V~ BV __ XO

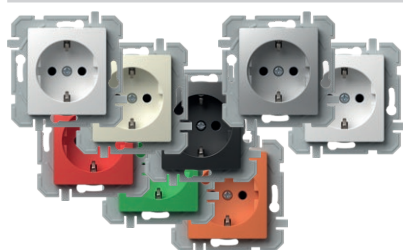

- VE12PWXO
- VE12IWXO
- VE12ESXO
- VE12COXO
- VE12NBXO
- VE12RDXO
- VE12GRXO
- VE12ORXO

- BV kontakte për futje telash 1,5-2,5 mm²
- XO pa kapak mbulues
- 2P+E schuko
- 16 A 250 V~, Iloji VE12

SOCKET SCHUKO 2P+E 16A 250V~ BV __ XO

- BV plug-in contacts 1.5-2.5mm²
- XO without surround
- 2P+E schuko
- 16A 250V~, type VE12



PRIZË SCHUKO+KAPAK 2P+E 16 A 250 V~ BV __ XO



- VE13PTXO
- VE13ITXO
- VE13STXO
- VE13BTXO
- VE13PPXO

- BV kontakte për futje telash 1,5-2,5 mm²
- XO pa kapak mbulues
- 2P+E schuko+kapak
- 16 A 250 V~, Iloji VE13

SOCKET SCHUKO+COVER 2P+E 16A 250V~ BV __ XO

- BV plug-in contacts 1.5-2.5mm²
- XO without surround
- 2P+E schuko+cover
- 16A 250V~, type VE13



PRIZË SCHUKO 2P+E 16 A 250 V~



- VE10PW
- VE10IW
- VE10ES
- VE10CO
- VE10NB

- kontaktet e vidave 1,5-2,5 mm²
- 2P+E schuko
- 16 A 250 V~, Iloji VE10

SOCKET SCHUKO 2P+E 16A 250V~

- screw contacts 1.5-2.5mm²
- 2P+E schuko
- 16A 250V~, type VE10



PRIZË SCHUKO+KAPAK 2P+E 16 A 250 V~



- VE11PT
- VE11IT
- VE11ST
- VE11CT
- VE11BT

- kontaktet e vidave 1,5-2,5 mm²
- 2P+E schuko+kapak
- 16 A 250 V~, Iloji VE11

SOCKET SCHUKO+COVER 2P+E 16A 250V~

- screw contacts 1.5-2.5mm²
- 2P+E schuko+cover
- 16A 250V~, type VE11



PRIZË SCHUKO 2P+E 16 A 250 V~ BV



- VE12PW
- VE12IW
- VE12ES
- VE12CO
- VE12NB

- BV kontakte për futje telash 1,5-2,5 mm²
- 2P+E schuko
- 16 A 250 V~, Iloji VE12

SOCKET SCHUKO 2P+E 16A 250V~ BV

- BV plug-in contacts 1.5-2.5mm²
- 2P+E schuko
- 16A 250V~, type VE12



PRIZË SCHUKO+KAPAK 2P+E 16 A 250 V~ BV



- VE13PT
- VE13IT
- VE13ST
- VE13CT
- VE13BT

- BV kontakte për futje telash 1,5-2,5 mm²
- 2P+E schuko+kapak
- 16 A 250 V~, Iloji VE13

SOCKET SCHUKO+COVER 2P+E 16A 250V~ BV

- BV plug-in contacts 1.5-2.5mm²
- 2P+E schuko+cover
- 16A 250V~, type VE13



S O C K E T S V E

PRIZË FRANCEZE 2P+E 16 A 250 V~ __ XO

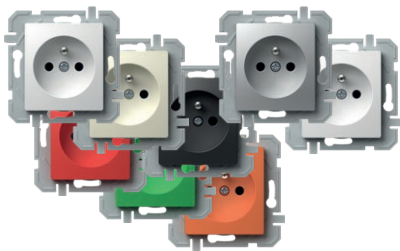

- VE40PWXO
- VE40IWXO
- VE40ESXO
- VE40COXO
- VE40NBXO
- VE40RDXO
- VE40GRXO
- VE40ORXO

- kontaktet e vidave 1,5-2,5 mm²
- XO pa kapak mbulues
- 2P+E Franceze
- 16 A 250 V~, lloji VE40

SOCKET FRENCH 2P+E 16A 250V~ __ XO

- screw contacts 1.5-2.5mm²
- XO without surround
- 2P+E French
- 16A 250V~, type VE40



PRIZË FRANCEZE+KAPAK 2P+E 16 A 250 V~ __ XO

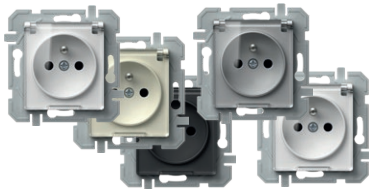

- VE41PTXO
- VE41ITXO
- VE41STXO
- VE41BTXO
- VE41PPXO

- kontaktet e vidave 1,5-2,5 mm²
- XO pa kapak mbulues
- 2P+E Franceze+kapak
- 16 A 250 V~, lloji VE41

SOCKET FRENCH+COVER 2P+E 16A 250V~ __ XO

- screw contacts 1.5-2.5mm²
- XO without surround
- 2P+E French+cover
- 16A 250V~, type VE41



PRIZË FRANCEZE 2P+E 16 A 250 V~ BV __ XO

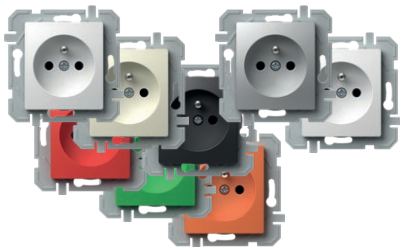

- VE42PWXO
- VE42IWXO
- VE42ESXO
- VE42COXO
- VE42NBXO
- VE42RDXO
- VE42GRXO
- VE42ORXO

- BV kontakte për futje telash 1,5-2,5 mm²
- XO pa kapak mbulues
- 2P+E Franceze
- 16 A 250 V~, lloji VE42

SOCKET FRENCH 2P+E 16A 250V~ BV __ XO

- BV plug-in contacts 1.5-2.5mm²
- XO without surround
- 2P+E French
- 16A 250V~, type VE42



PRIZË FRANCEZE+KAPAK 2P+E 16 A 250 V~ BV __ XO



- VE43PTXO
- VE43ITXO
- VE43STXO
- VE43BTXO
- VE43PPXO

- BV kontakte për futje telash 1,5-2,5 mm²
- XO pa kapak mbulues
- 2P+E Franceze+kapak
- 16 A 250 V~, lloji VE43

SOCKET FRENCH+COVER 2P+E 16A 250V~ BV __ XO

- BV plug-in contacts 1.5-2.5mm²
- XO without surround
- 2P+E French+cover
- 16A 250V~, type VE43



PRIZË FRANCEZE 2P+E 16 A 250 V~



- VE40PW
- VE40IW
- VE40ES
- VE40CO
- VE40NB

- kontaktet e vidave 1,5-2,5 mm²
- 2P+E Franceze
- 16 A 250 V~, lloji VE40

SOCKET FRENCH 2P+E 16A 250V~

- screw contacts 1.5-2.5mm²
- 2P+E French
- 16A 250V~, type VE40



PRIZË FRANCEZE+KAPAK 2P+E 16 A 250 V~



- VE41PT
- VE41IT
- VE41BT
- VE41ST

- kontaktet e vidave 1,5-2,5 mm²
- 2P+E Franceze+kapak
- 16 A 250 V~, lloji VE41

SOCKET FRENCH+COVER 2P+E 16A 250V~

- screw contacts 1.5-2.5mm²
- 2P+E French+cover
- 16A 250V~, type VE41



PRIZË FRANCEZE 2P+E 16 A 250 V~ BV



- VE42PW
- VE42IW
- VE42ES
- VE42CO
- VE42NB

- BV kontakte për futje telash 1,5-2,5 mm²
- 2P+E Franceze
- 16 A 250 V~, lloji VE42

SOCKET FRENCH 2P+E 16A 250V~ BV

- BV plug-in contacts 1.5-2.5mm²
- 2P+E French
- 16A 250V~, type VE42



PRIZË FRANCEZE+KAPAK 2P+E 16 A 250 V~ BV



- VE43PT
- VE43IT
- VE43BT
- VE43ST

- BV kontakte për futje telash 1,5-2,5 mm²
- 2P+E Franceze+kapak
- 16 A 250 V~, lloji VE43

SOCKET FRENCH+COVER 2P+E 16A 250V~ BV

- BV plug-in contacts 1.5-2.5mm²
- 2P+E French+cover
- 16A 250V~, type VE43



PRIZË SCHUKO DYSHE 2P+E 16 A 250 V~



- VE16PWKS
- VE16IWKS
- VE16ESKS
- VE16NBKS

- 2P+E schuko dyshe
- 16 A 250 V~, lloji VE16
- në përputhje me IEC 60884-1, CEE7
- kontaktet e vidave 1,5-2,5 mm²
- kontaktet me rrymën të mbuluara

SOCKET SCHUKO DOUBLE 2P+E 16A 250V~

- 2P+E schuko double
- 16 A 250V~, type VE16
- in accordance with IEC 60884-1, CEE7
- screw contacts 1.5-2.5 mm²
- shuttered live contacts



PRIZË FRANCEZE DYSHE 2P+E 16 A 250 V~



- VE46PWKS
- VE46IWKS
- VE46ESKS
- VE46NBKS

- 2P+E franceze dyshe
- 16 A 250 V~, lloji VE46
- në përputhje me IEC 60884-1, CEE7; NF C 61-314, CSN 33 2318; PN-E 93201
- kontaktet e vidave 1,5-2,5 mm²
- kontaktet me rrymën të mbuluara

SOCKET FRENCH DOUBLE 2P+E 16A 250V~

- 2P+E French double
- 16 A 250V~, type VE46
- in accordance with IEC 60884-1, CEE7; NF C 61-314, CSN 33 2318; PN-E 93201
- screw contacts 1.5-2.5 mm²
- shuttered live contacts



PRIZË 2P 16 A 250 V~

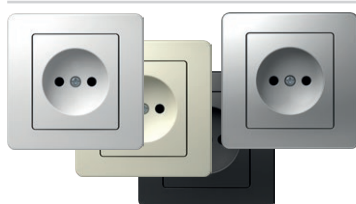

- VE30PW
- VE30IW
- VE30ES
- VE30NB

- 2P pa kontakt për tokëzimin
- 16 A 250 V~
- në përputhje me EN 60884-1, CEE7 (fleta e standardit I)
- kontaktet e vidave 1,5-2,5 mm²

SOCKET 2P 16A 250V~

- 2P without earthing contact
- 16 A 250V~
- in accordance with EN 60884-1, CEE7 (standard sheet I)
- screw contacts 1.5-2.5mm²

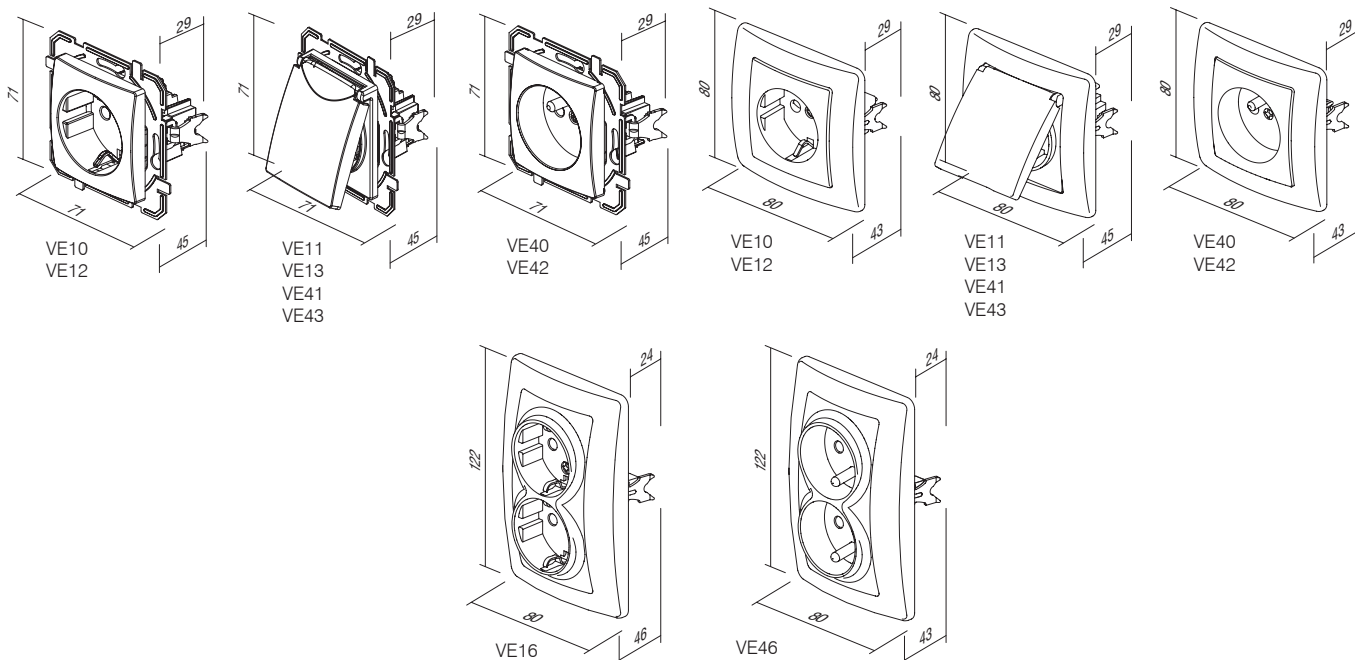



KE37

PW

Iloji type	përshkrimi description	të dhënat teknike technical data	ngjyra colour
KE11	PRIZË TV-R ME KAPAK FUNDOR SOCKET TV-R END-LINE	1dB	<input type="checkbox"/> PW e bardhë polare polar white
KE12	PRIZË TV-R KALUESE SOCKET TV-R THROUGHPASS	10dB	<input type="checkbox"/> IW e bardhë fildishi ivory white
KE16	PRIZË SAT-TV-R ME KAPAK FUNDOR SOCKET SAT-TV-R END-LINE	3dB	<input type="checkbox"/> ES e argjendtë elox elox silver
⋮	⋮	⋮	<input type="checkbox"/> CO termoset i bardhë white thermoset
⋮	⋮	⋮	<input type="checkbox"/> NB e zezë mesnate night black

PRIZË TV-R ME KAPAK FUNDOR 1dB



KE11

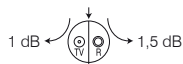

- TV-R me kapak fundor
- gama e frekuencës 5-862MHz
- reduktimi: R-1.5dB, TV-1dB
- në përputhje me EN 50083-1
- kontaktet e vidave

SOCKET TV-R END-LINE 1dB

- TV-R end-line
- frequency range 5-862MHz
- reduction: R-1.5dB, TV-1dB
- in accordance with EN 50083-1
- screw contacts

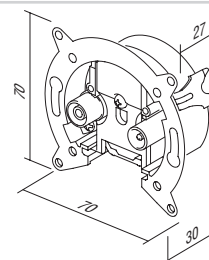

PRIZË TV-R KALUESE 10dB



KE12

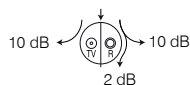

- TV-R kaluese
- gama e frekuencës 5-862MHz
- reduktimi: R-10dB, TV-10dB, kaluese-2dB
- në përputhje me EN 50083-1
- kontaktet e vidave

SOCKET TV-R TROUGHPASS 10dB

- TV-R troughpass
- frequency range 5-862MHz
- reduction: R-10dB, TV-10dB, trough-2dB
- in accordance with EN 50083-1
- screw contacts

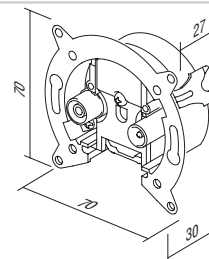

PRIZË SAT-TV-R ME KAPAK FUNDOR 3dB



KE16

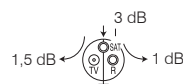

- SAT-TV-R me kapak fundor
- gama e frekuencës 5-2400MHz
- reduktimi: R-1dB, TV-1.5dB, SAT-3dB
- për montim në kuti të rumbullakët Ø60 me kthetra ose vida
- në përputhje me EN 50083-1
- kontaktet e vidave

SOCKET SAT-TV-R END-LINE 3dB

- SAT-TV-R end-line
- frequency range 5-2400MHz
- reduction: R-1dB, TV-1.5dB, SAT-3dB
- for mounting in round box Ø60 with claws or screws
- in accordance with EN 50083-1
- screw contacts

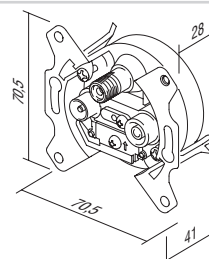

PRIZË TEL KS RJ11 6/4

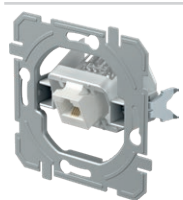

KE36

- standard fiksues trapez KS
- RJ11 6/4
- në përputhje me IEC 60603-7

SOCKET TEL KS RJ11 6/4

- KS keystone fixing standard
- RJ11 6/4
- in accordance with IEC 60603-7

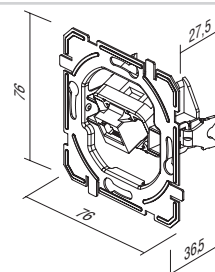

	KE37	PRIZË CAT5e KS RJ45 8/8 - standard fiksues trapez KS - CAT5e, RJ45 8/8 - në përputhje me IEC 60603-7 <i>SOCKET CAT5e KS RJ45 8/8</i> - KS keystone fixing standard - CAT5e, RJ45 8/8 - in accordance with IEC 60603-7	
	KE40	PRIZË CAT6s KS RJ45 8/8 SLIM - standard fiksues trapez KS - CAT6s, RJ45 8/8 - në përputhje me IEC 60603-7 <i>SOCKET CAT6s KS RJ45 8/8 SLIM</i> - KS keystone fixing standard - CAT6s, RJ45 8/8 - in accordance with IEC 60603-7	
	KE38	PRIZË TEL KS DYSHE 2x RJ11 6/4 - standard fiksues trapez KS - 2x RJ11 6/4 - në përputhje me IEC 60603-7 <i>SOCKET TEL KS DOUBLE 2x RJ11 6/4</i> - KS keystone fixing standard - 2x RJ11 6/4 - in accordance with IEC 60603-7	
	KE39	PRIZË CAT5e KS DYSHE 2x RJ45 8/8 - standard fiksues trapez KS - 2x CAT5e, RJ45 8/8 - në përputhje me IEC 60603-7 <i>SOCKET CAT5e KS DOUBLE 2x RJ45 8/8</i> - KS keystone fixing standard - 2x CAT5e, RJ45 8/8 - in accordance with IEC 60603-7	
	KE41	PRIZË CAT6s KS DYSHE 2x RJ45 8/8 SLIM - standard fiksues trapez KS - 2x CAT6s, RJ45 8/8 - në përputhje me IEC 60603-7 <i>SOCKET CAT6s KS DOUBLE 2x RJ45 8/8 SLIM</i> - KS keystone fixing standard - 2x CAT6s, RJ45 8/8 - in accordance with IEC 60603-7	
	KE45	PËRSHTATËS KS NJËSH - standard fiksues trapez KS - njësh - AMP, Avaya, Brandrex, FMT, Mfico, Tyco, ... - moduli i komunikimit nuk përfshihet <i>ADAPTER KS SINGLE</i> - KS keystone fixing standard - single - AMP, Avaya, Brandrex, FMT, Mfico, Tyco, ... - communication module not included	

PËRSHTATËS KS DYSH

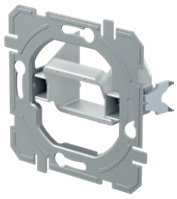

KE46

- standard fiksues trapez KS - dysh
- AMP, Tyco, ...
- moduli i komunikimit nuk përfshihet

ADAPTER KS DOUBLE

- KS keystone fixing standard - double
- AMP, Tyco, ...
- communication module not included

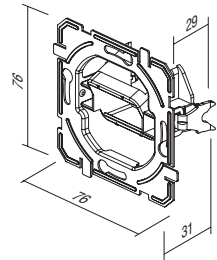

PËRSHTATËS PD DYSH



KE47

- standard fiksues PD Panduit Mini-COM - dysh
- moduli i komunikimit nuk përfshihet

ADAPTER PD DOUBLE

- PD Panduit Mini-COM fixing standard - double
- communication module not included

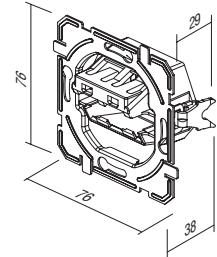

PRIZË TV BAZË 0dB



- KE10PW
- KE10IW
- KE10ES
- KE10CO
- KE10NB

- TV bazë
- reduktim 0dB
- lidhje e pasme – F standarde

SOCKET TV BASIC 0dB

- TV basic
- reduction 0dB
- back connector – F standard



PRIZË TV-R ME KAPAK FUNDOR 1dB



- KE11PW
- KE11IW
- KE11ES
- KE11CO
- KE11NB

- TV-R me kapak fundor
- gama e frekuencës 5÷862 MHz
- reduktimi: R-1.5dB, TV-1dB
- në përputhje me EN 50083-1
- kontaktet e vidave

SOCKET TV-R END-LINE 1dB

- TV-R end-line
- frequency range 5÷862 MHz
- reduction: R-1.5dB, TV-1dB
- in accordance with EN 50083-1
- screw contact



PRIZË TV-R KALUESE 10dB



- KE12PW
- KE12IW
- KE12ES
- KE12CO
- KE12NB

- TV-R kaluese
- gama e frekuencës 5÷862 MHz
- reduktimi: R-10dB, TV-10dB, kaluese-2dB
- në përputhje me EN 50083-1
- kontaktet e vidave

SOCKET TV-R TROUGHPASS 10dB

- TV-R troughpass
- frequency range 5÷862 MHz
- reduction: R-10dB, TV-10dB, trough-2dB
- in accordance with EN 50083-1
- screw contacts



PRIZË SAT-TV-R ME KAPAK FUNDOR 3dB



- KE16PW
- KE16IW
- KE16ES
- KE16CO
- KE16NB

- SAT-TV-R me kapak fundor
- gama e frekuencës 5÷2400 MHz
- reduktimi: R-1dB, TV-1.5dB, SAT-3dB
- në përputhje me EN 50083-1
- kontaktet e vidave

SOCKET SAT-TV-R END-LINE 3dB

- SAT-TV-R end-line
- frequency range 5÷2400 MHz
- reduction: R-1dB, TV-1.5dB, SAT-3dB
- in accordance with EN 50083-1
- screw contacts



PRIZË AUDIO 2xRCA



- KE22PW
- KE22IW
- KE22ES
- KE22CO
- KE22NB

- audio 2xRCA
- lidhje me saldime e kablllos

SOCKET AUDIO 2xRCA

- audio 2xRCA
- soldering connection of cable



PRIZË AUDIO ALTOPARLANTË



- KE23PW
- KE23IW
- KE23ES
- KE23CO
- KE23NB

- audio 2x Ø4mm
- për të mbajtur telin e altoparlantit, spinë banane Ø4 mm ose maç
- lidhje me ngjitje e kablllos në pjesën e pasme

SOCKET AUDIO LOUDSPEAKERS

- audio 2x Ø4mm
- to accommodate speaker wire, banana plug Ø4mm or spades
- soldering connection of cable at the back side



PRIZË TEL KS RJ11 6/4

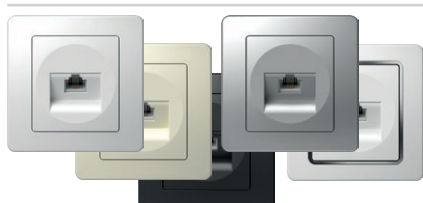

- KE36PW
- KE36IW
- KE36ES
- KE36CO
- KE36NB

- standard fiksues trapez KS
- RJ11 6/4
- në përputhje me IEC 60603-7

SOCKET TEL KS RJ11 6/4

- KS keystone fixing standard
- RJ11 6/4
- in accordance with IEC 60603-7





- KE37PW
- KE37IW
- KE37ES
- KE37CO
- KE37NB

PRIZË CAT5e KS RJ45 8/8

- standard fiksues trapez KS
- CAT5e, RJ45 8/8
- në përputhje me IEC 60603-7

SOCKET CAT5e KS RJ45 8/8

- KS keystone fixing standard
- CAT5e, RJ45 8/8
- in accordance with IEC 60603-7



- KE40PW
- KE40IW
- KE40ES
- KE40CO
- KE40NB

PRIZË CAT6s KS RJ45 8/8 SLIM

- standard fiksues trapez KS
- CAT6s, RJ45 8/8
- në përputhje me IEC 60603-7

SOCKET CAT6s KS RJ45 8/8 SLIM

- KS keystone fixing standard
- CAT6s, RJ45 8/8
- in accordance with IEC 60603-7



- KE38PW
- KE38IW
- KE38ES
- KE38CO
- KE38NB

PRIZË TEL KS DYSHE 2x RJ11 6/4

- standard fiksues trapez KS
- 2x RJ11, 6/4
- në përputhje me IEC 60603-7

SOCKET TEL KS DOUBLE 2x RJ11 6/4

- KS keystone fixing standard
- 2x RJ11, 6/4
- in accordance with IEC 60603-7



- KE39PW
- KE39IW
- KE39ES
- KE39CO
- KE39NB

PRIZË CAT5e KS DYSHE 2x RJ45 8/8

- standard fiksues trapez KS
- 2x CAT5e, RJ45 8/8
- në përputhje me IEC 60603-7

SOCKET CAT5e KS DOUBLE 2x RJ45 8/8

- KS keystone fixing standard
- 2x CAT5e, RJ45 8/8
- in accordance with IEC 60603-7



- KE41PW
- KE41IW
- KE41ES
- KE41CO
- KE41NB

PRIZË CAT6s KS DYSHE 2x RJ45 8/8 SLIM

- standard fiksues trapez KS
- 2x CAT6s, RJ45 8/8
- në përputhje me IEC 60603-7

SOCKET CAT6s KS DOUBLE 2x RJ45 8/8 SLIM

- KS keystone fixing standard
- 2x CAT6s, RJ45 8/8
- in accordance with IEC 60603-7

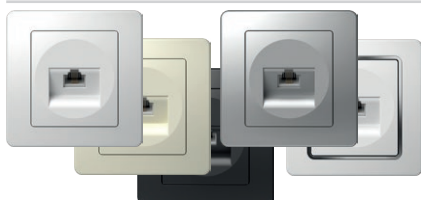

- KE35PW
- KE35IW
- KE35ES
- KE35CO
- KE35NB

PRIZË TEL LT RJ11 6/4

- vidë TEL LT
- kontaktet e vidave
- RJ11 6/4
- në përputhje me IEC 60603-7

SOCKET TEL LT RJ11 6/4

- TEL LT screw
- screw contacts
- RJ11 6/4
- in accordance with IEC 60603-7

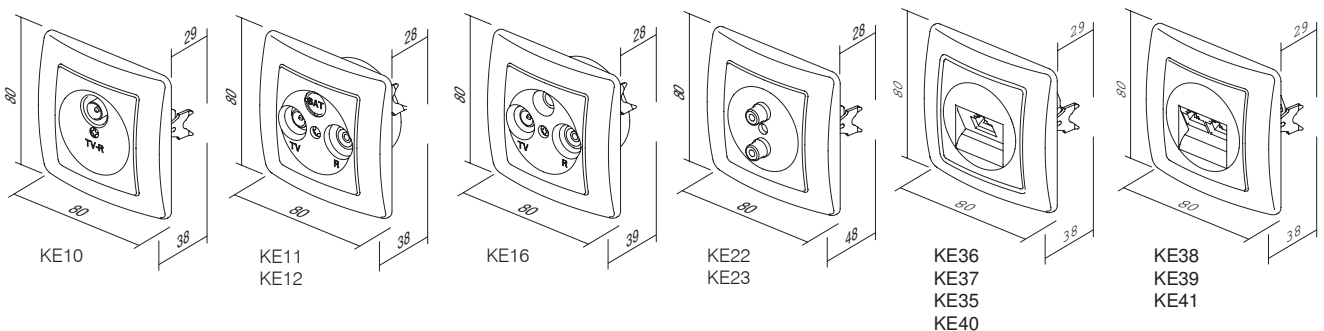

K A P A K P Ë R K O M U N I K I M E T K E

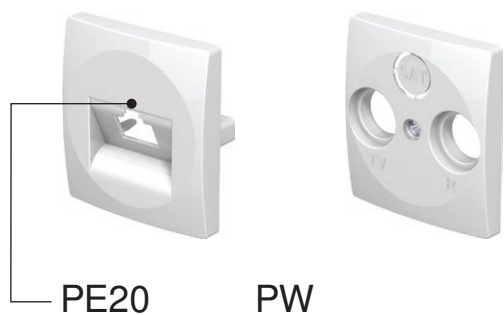

lloji type	përshkrimi description	të dhënat teknike technical data	ngjyra colour
PE10	KAPAK TV-R COVER TV-R	2P/3P	<input type="checkbox"/> PW e bardhë polare polar white
PE20	KAPAK KS NJËSH COVER KS SINGLE		<input type="checkbox"/> IW e bardhë fildishi ivory white
PE21	KAPAK KS DYSH COVER KS DOUBLE		<input type="checkbox"/> ES e argjendtë elox elox silver
⋮	⋮	⋮	<input type="checkbox"/> CO termoset i bardhë white thermoset
			<input type="checkbox"/> NB e zezë mesnate night black

KAPAK TV-R 2P/3P

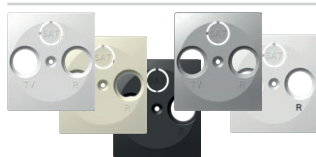

- PE10PW
- PE10IW
- PE10ES
- PE10CO
- PE10NB

- kapak TV-R, 2P ose 3P me vidë

COVER TV-R 2P/3P

- TV-R cover, 2P or 3P with screw



KAPAK KS NJËSH

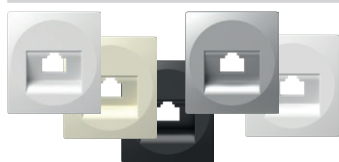

- PE20PW
- PE20IW
- PE20ES
- PE20CO
- PE20NB

- kapak KS njësh

COVER KS SINGLE

- KS cover single



KAPAK KS DYSH

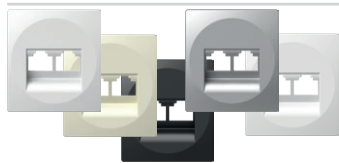

- PE21PW
- PE21IW
- PE21ES
- PE21NB

- kapak KS dysh

COVER KS DOUBLE

- KS cover double



KAPAK TAE/TDO



- PE30PW
- PE30IW
- PE30ES
- PE30NB

- kapak TAE ose TDO me vidë

COVER TAE/TDO

- TAE or TDO cover with screw

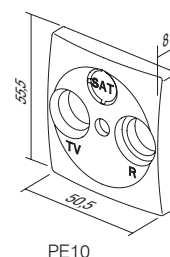
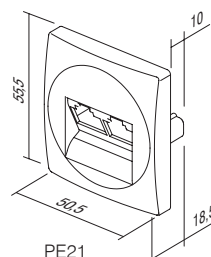
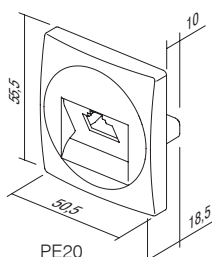
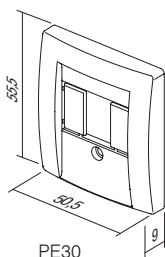



EE15

PW

lloji type	përshkrimi description	të dhënat teknike technical data	ngjyra colour
EE15	REOSTAT RROTULLUES ME 2 DREJTIME DIMMER ROTATIVE 2WAY	RL 400W	<input type="checkbox"/> PW e bardhë polare polar white
EE16	REOSTAT RROTULLUES ME 2 DREJTIME DIMMER ROTATIVE 2WAY	RLC 400W	<input type="checkbox"/> IW e bardhë fildishi ivory white
EE19	REOSTAT RROTULLUES ME 2 DREJTIME DIMMER ROTATIVE 2WAY	LED 100W	<input type="checkbox"/> ES e argjendtë elox elox silver
⋮	⋮	⋮	<input type="checkbox"/> CO termoset i bardhë white thermoset
⋮	⋮	⋮	<input type="checkbox"/> NB e zezë mesnate night black

REOSTAT RROTULLUES ME 2 DREJTIME RL 400 W



EE15

- kontroll i rrotullimit me çelësin me 2 drejtime
- RL i ngarkesës, 40 W - 400W
- është i mundur kombinimi i çelësit me 2 drejtime
- nuk lejohet kombinim i më shumë reostateve
- në përputhje me standardet EN 60669-1 dhe EN 60669-2-1
- kontakte për futje telash 1,5 mm²
- tensioni i furnizimit, 230 V ~ 50 Hz
- diametri i brendshëm i butonit Ø6 mm
- përfshihet siguresa e zëvendësueshme

DIMMER ROTATIVE 2WAY RL 400W

- rotation control with 2-way switch
- load RL, 40W - 400W
- 2-way switch combination is possible
- more dimmers combination is not allowed
- in accordance with EN 60669-1 and EN 60669-2-1
- plug-in contacts 1.5mm²
- supply 230V~ 50Hz
- button inner diameter Ø6mm
- replaceable fuse included

REOSTAT RROTULLUES ME 2 DREJTIME RLC 400 W



EE16

- kontroll i rrotullimit me çelësin me 2 drejtime
- RLC i ngarkesës, 20W - 400W
- është i mundur kombinimi i çelësit me 2 drejtime
- nuk lejohet kombinim i më shumë reostateve
- në përputhje me standardet EN 60669-1 dhe EN 60669-2-1
- kontakte për futje telash 1,5 mm²
- tensioni i furnizimit, 230 V ~ 50 Hz
- diametri i brendshëm i butonit Ø6 mm
- siguresë elektronike

DIMMER ROTATIVE 2WAY RLC 400W

- rotation control with 2-way switch
- load RLC, 20W - 400W
- 2-way switch combination is possible
- more dimmers combination is not allowed
- in accordance with EN 60669-1 and EN 60669-2-1
- plug-in contacts 1.5mm²
- supply 230V~ 50Hz
- button inner diameter Ø6mm
- electronic fuse



EE19

REOSTAT RROTULLUES ME 2 DREJTIME LED 100W

- kontroll i rrotullimit me çelësin me 2 drejtime
- ngarkesa: LED, 0-100 W (maks. 10 LED-e)
GLS, 10-250 W
- është i mundur kombinimi i çelësit me 2 drejtime
- nuk lejohet kombinim i më shumë reostateve
- në përputhje me standardet EN 60669-1 dhe EN 60669-2-1
- kontakte për futje telash 1,5 mm²
- tensioni i furnizimit, 230 V ~ 50 Hz
- përfshihet siguresa e zëvendësueshme
- diametri i brendshëm i butonit Ø6 mm

DIMMER ROTATIVE 2WAY LED 100W

- rotation control with 2-way switch
- load: LED, 0-100W (max. 10 LEDs)
GLS, 10-250W
- 2-way switch combination is possible
- more dimmers combination is not allowed
- in accordance with EN 60669-1 and EN 60669-2-1
- plug-in contacts 1.5mm²
- supply 230V~ 50Hz
- replaceable fuse included
- button inner diameter Ø6mm

ÇELËS IR 5A X 250V~

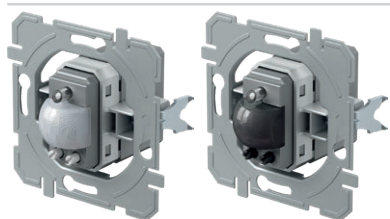

- EE32A1
- EE32A2

- çelës IR me infra të kuqe
- furnizimi me energji: 230 V ~ ±10 % 50 Hz
- rele: 5 A / 250 V~ (zero kryqëzim)
- vlerësimi i mbrojtjes: IP40
- prerja e tërthortë e telave në kontakt 0,75 - 2,5 mm²
- zona e zbulimit: deri në 110° në 20°C
- zona e zbulimit: rreth 8 m në 20°C
- rregullimi i kohëzgjatjes: nga rreth 5 sek. në 12 min.
- rregullimi i ndriçimit: nga rreth 5 deri 200 LUX
- temperatura e funksionimit: nga 0°C në +40°C
- i papërshatshëm për instalim në kuti me thellësi 45 mm
- vetëm për përdorim të brendshëm

IR SWITCH 5A 230V~

- IR infrared switch
- supply voltage: 230V~ ±10 % 50Hz
- relay: 5A / 250V~ (zero crossing)
- protection rating: IP40
- cross-section of wires at the contact terminal: 0.75 - 2.5 mm²
- detection angle: up to 110° at 20°C
- detection area: approx. 8 m at 20°C
- adjustability of duration: from approx. 5 s to 12 min
- adjustability of brightness: from approx. 5 to 200 LUX
- operating temperature: from 0°C to +40°C
- not suitable for installation in 45 mm deep boxes
- only for indoor usage

NJËSIA E FURNIZIMIT ME ENERGJI USB 5 V 2,4 A



EE67

- për karikimin e pajisjeve elektronike përmes një porte standarde USB (e përputhshme gjithashtu edhe me pajisjet Apple)
- furnizimi me energji: 100-230 V~ 50/60 Hz
- konsumi i energjisë: 300 mA në 100 V~/150 mA në 230 V~
- konsumi i energjisë në gatishmëri: 30mW në 230 V~
- tensioni nominal në dalje: 5 VCD (±5 %) SELV
- tensioni i ondulacionit në dalje: 150 mV
- rryma nominale në dalje: 2,4 A (±10%)
- lloji i konektorit: USB A / USB A
- efikasiteti: maksimumi 77%
- temperatura e funksionimit: 0°C/+45°C (përdorimi i brendshëm)
- klasi i mbrojtjes IP: IP20, vetëm për përdorim në ambiente të brendshme
- klasi i pajisjes II
- kategoria e mbtensionit (EN 62109): Klasi III
- kontaktet e vidave maks. 2,5 mm²
- pajisje me hapësirë kontakti prej të paktën 3 mm
- në përputhje me standardet EN 60950-1 dhe Direktivës LVC dhe EMC

USB POWER SUPPLY UNIT 5V 2.4A

- for charging electronic devices via a standard USB port (also compatible with Apple devices)
- power supply: 100-230V~ 50/60Hz
- power consumption: 300mA at 100V~/150mA at 230V~
- standby power consumption: 30mW at 230V~
- nominal output voltage: 5 VCD (± 5%) SELV
- output ripple voltage: 150mV
- nominal output current: 2.4A (±10%)
- connector type: USB A / USB A
- efficiency: maximum of 77%
- operating temperature: 0°C/+45°C (indoor use)
- IP protection class: IP20, indoor use only
- class device II
- overvoltage category (EN 62109): Class III
- screw contacts: max. 2.5 mm²
- device with a contact gap of at least 3mm
- in accordance with the EN 60950-1 and LVD & EMC directives

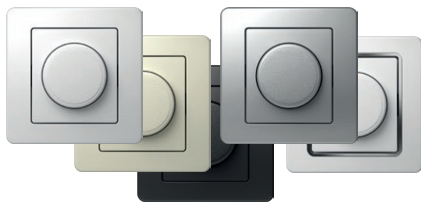

- EE15PW
- EE15IW
- EE15ES
- EE15CO
- EE15NB

REOSTAT RROTULLUES ME 2 DREJTIME RL 400 W

- kontroll i rrotullimit me çelësin me 2 drejtime
- RL i ngarkesës, 40 W - 400W
- është i mundur kombinimi i çelësit me 2 drejtime
- nuk lejohet kombinim i më shumë reostateve
- në përputhje me standardet EN 60669-1 dhe EN 60669-2-1
- kontakte për futje telash 1,5 mm²
- tensioni i furnizimit, 230 V ~ 50 Hz
- përfshihet siguresa e zëvendësueshme

DIMMER ROTATIVE 2WAY RL 400W

- rotation control with 2-way switch
- load RL, 40W - 400W
- 2-way switch combination is possible
- more dimmers combination is not allowed
- in accordance with EN 60669-1 and EN 60669-2-1
- plug-in contacts 1.5mm²
- supply 230V~ 50Hz
- replaceable fuse included

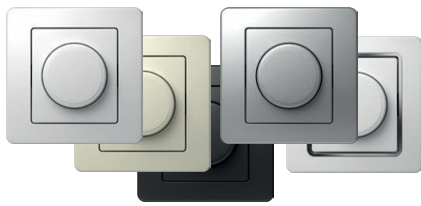

- EE16PW
- EE16IW
- EE16ES
- EE16CO
- EE16NB

REOSTAT RROTULLUES ME 2 DREJTIME RLC 400 W

- kontroll i rrotullimit me çelësin me 2 drejtime
- RLC i ngarkesës, 20W - 400W
- është i mundur kombinimi i çelësit me 2 drejtime
- nuk lejohet kombinim i më shumë reostateve
- në përputhje me standardet EN 60669-1 dhe EN 60669-2-1
- kontakte për futje telash 1,5 mm²
- tensioni i furnizimit, 230 V ~ 50 Hz
- siguresë elektronike

DIMMER ROTATIVE 2WAY RLC 400W

- rotation control with 2-way switch
- load RLC, 20W - 400W
- 2-way switch combination is possible
- more dimmers combination is not allowed
- in accordance with EN 60669-1 and EN 60669-2-1
- plug-in contacts 1.5mm²
- supply 230V~ 50Hz
- electronic fuse

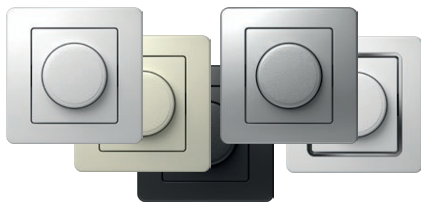

- EE19PW
- EE19IW
- EE19ES
- EE19CO
- EE19NB

REOSTAT RROTULLUES ME 2 DREJTIME LED 100W

- kontroll i rrotullimit me çelësin me 2 drejtime
- ngarkesa: LED, 0-100 W (maks. 10 LED-e)
- GLS, 10-250 W
- është i mundur kombinimi i çelësit me 2 drejtime
- nuk lejohet kombinim i më shumë reostateve
- në përputhje me standardet EN 60669-1 dhe EN 60669-2-1
- kontakte për futje telash 1,5 mm²
- tensioni i furnizimit, 230 V ~ 50 Hz
- përfshihet siguresa e zëvendësueshme

DIMMER ROTATIVE 2WAY LED 100W

- rotation control with 2-way switch
- load: LED, 0-100W (max. 10 LEDs)
- GLS, 10-250W
- 2-way switch combination is possible
- more dimmers combination is not allowed
- in accordance with EN 60669-1 and EN 60669-2-1
- plug-in contacts 1.5mm²
- supply 230V~ 50Hz
- replaceable fuse included



- EE32PW
- EE32IW
- EE32ES
- EE32CO
- EE32NB

ÇELËS IR 5A X 230V~

- çelës IR me infra të kuqe
- furnizimi me energji: 230 V~ ±10 % 50 Hz
- rele: 5 A / 250 V~ (zero kryqëzim)
- vlerësimi i mbrojtjes: IP40
- preja e tërthorë e telave në kontakt 0,75 - 2,5 mm²
- zona e zbulimit: deri në 110° në 20°C
- zona e zbulimit: rreth 8 m në 20°C
- rregullimi i kohëzgjatjes: nga rreth 5 sek. në 12 min.
- rregullimi i ndriçimit: nga rreth 5 deri 200 LUX
- temperatura e funksionimit: nga 0°C në +40°C
- i papërshtatshëm për instalim në kuti me thellësi 45 mm
- vetëm për përdorim të brendshëm

IR SWITCH 5A 230V~

- IR infrared switch
- supply voltage: 230V~ ±10 % 50Hz
- relay: 5A / 250V~ (zero crossing)
- protection rating: IP40
- cross-section of wires at the contact terminal: 0.75 - 2.5 mm²
- detection angle: up to 110° at 20°C
- detection area: approx. 8 m at 20°C
- adjustability of duration: from approx. 5 s to 12 min
- adjustability of brightness: from approx. 5 to 200 LUX
- operating temperature: from 0°C to +40°C
- not suitable for installation in 45 mm deep boxes
- only for indoor usage





- EE67PW
- EE67IW
- EE67NB
- EE67ES

NJËSIA E FURNIZIMIT ME ENERGJI USB 5 V 2,4 A

- për karikimin e pajisjeve elektronike përmes një porte standarde USB (e përputhshme gjithashtu edhe me pajisjet Apple)
- furnizimi me energji: 100-230 V~ 50/60 Hz
- konsumi i energjisë: 300 mA në 100 V~/150 mA në 230 V~
- konsumi i energjisë në gatishtëri: 30mW në 230 V~
- tensioni nominal në dalje: 5 VCD ($\pm 5\%$) SELV
- tensioni i ondulacionit në dalje: 150 mV
- rryma nominale në dalje: 2,4 A ($\pm 10\%$)
- lloji i konektorit: USB A / USB A
- efikasiteti: maksimumi 77%
- temperatura e funksionimit: 0°C/+45°C (përdorimi i brendshëm)
- klasi i mbrojtjes IP: IP20, vetëm për përdorim në ambiente të brendshme
- klasi i pajisjes II
- kategoria e mbritensionit (EN 62109): Klasi III
- kontaktet e vidave maks. 2,5 mm²
- pajisje me hapësirë kontakti prej të paktën 3 mm
- në përputhje me standardet EN 60950-1 dhe Direktivës LVC dhe EMC



USB POWER SUPPLY UNIT 5V 2.4A

- for charging electronic devices via a standard USB port (also compatible with Apple devices)
- power supply: 100-230V~ 50/60Hz
- power consumption: 300mA at 100V~/150mA at 230V~
- standby power consumption: 30mW at 230V~
- nominal output voltage: 5 VCD ($\pm 5\%$) SELV
- output ripple voltage: 150mV
- nominal output current: 2.4A ($\pm 10\%$)
- connector type: USB A / USB A
- efficiency: maximum of 77%
- operating temperature: 0°C/+45°C (indoor use)
- IP protection class: IP20, indoor use only
- class device II
- overvoltage category (EN 62109): Class III
- screw contacts: max. 2.5 mm²
- device with a contact gap of at least 3mm
- in accordance with the EN 60950-1 and LVD & EMC directives

EE15, EE16, EE19

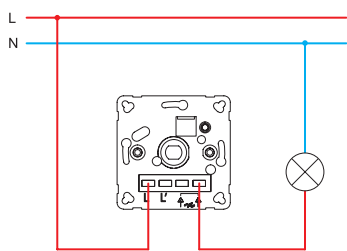

EE15, EE16, EE19

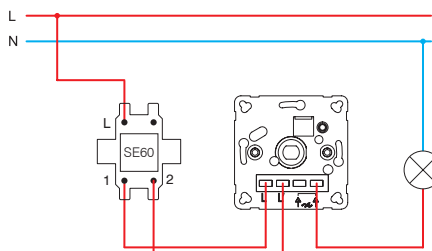

EE15, EE16, EE19

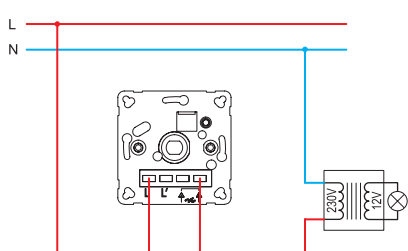

EE15, EE16, EE19

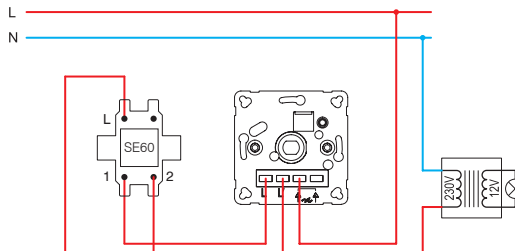

EE16, EE19

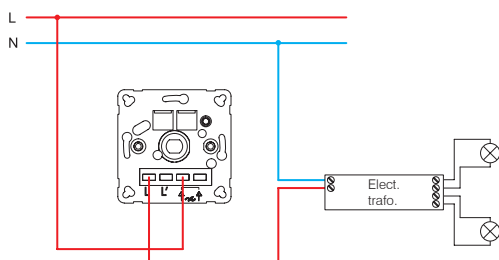

EE16, EE19

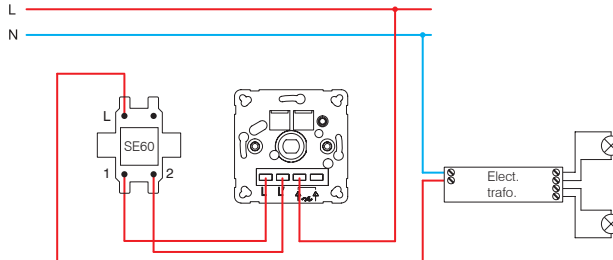

EE15 (40÷400W)

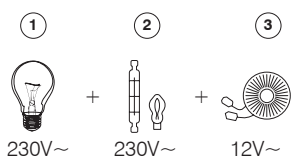

- 1 - llambë inkandeshente / incandescent lamp
- 2 - llambë halogjene / halogen lamp

EE16 (20÷400W)

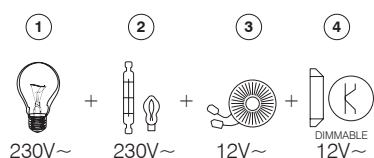

- 3 - transformator klasik / classical transformer
- 4 - transformator elektrik me dimer / dimmable electronic transformer

EE19 (GLS 10÷250W ; LED 0÷100W)

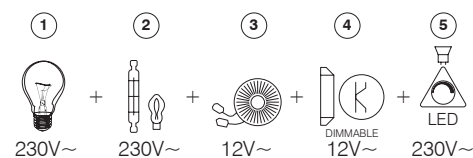

- 5 - llambë LED me ulje ndriçimi / dimmable LED lamp

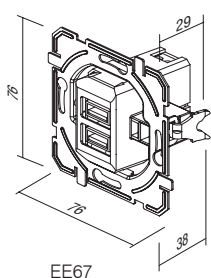

EE67

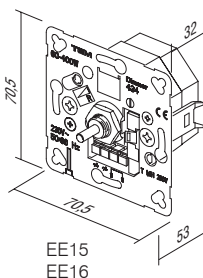

EE15
EE16
EE19

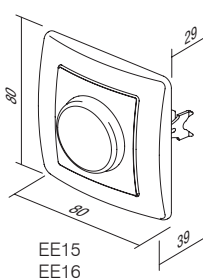

EE15
EE16
EE19

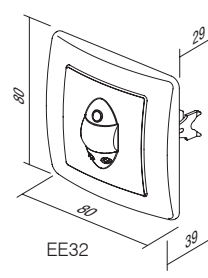

EE32

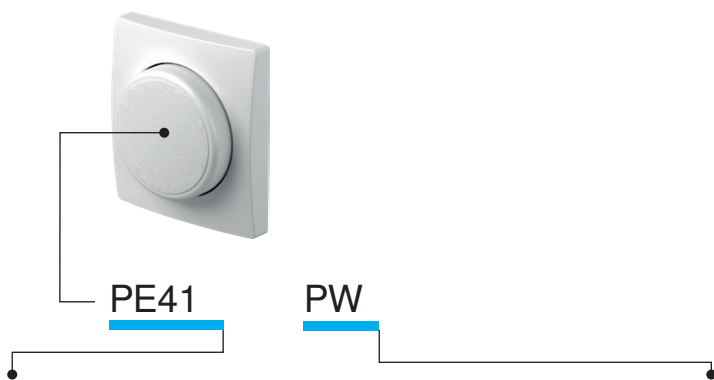

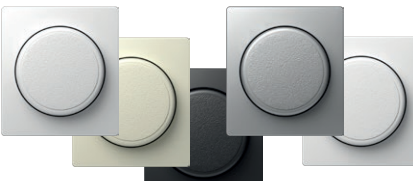

lloji type	përshkrimi description	ngjyra colour
PE41	REOSTAT ME KAPAK COVER DIMMER	<input type="checkbox"/> PW e bardhë polare polar white <input type="checkbox"/> IW e bardhë fildishi ivory white <input type="checkbox"/> ES e argjendtë elox elox silver <input type="checkbox"/> CO termoset i bardhë white thermoset <input type="checkbox"/> NB e zezë mesnate night black



PE41PW
 PE41IW
 PE41NB
 PE41ES
 PE41CO

REOSTAT ME KAPAK Ø6
 - reostat me kapak Ø6 mm
 - me EE15, EE16, EE19
COVER DIMMER Ø6
 - cover dimmer Ø6mm
 - for EE15, EE16, EE19





PE32PW
 PE32IW
 PE32NB
 PE32ES

KAPAK ÇELËS IR
 - kapak çelës IR
COVER IR SWITCH
 - cover IR switch





PE67PW
 PE67IW
 PE67NB
 PE67ES

NJËSIA E FURNIZIMIT ME USB ME KAPAK
 - Kapaku i njësisë së furnizimit me USB
USB SUPPLY UNIT COVER
 - USB supply unit cover



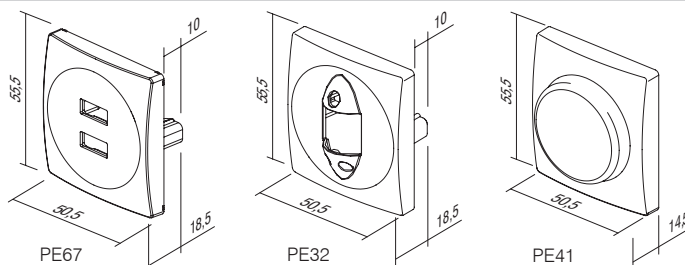

A C C E S S O R I E S A E

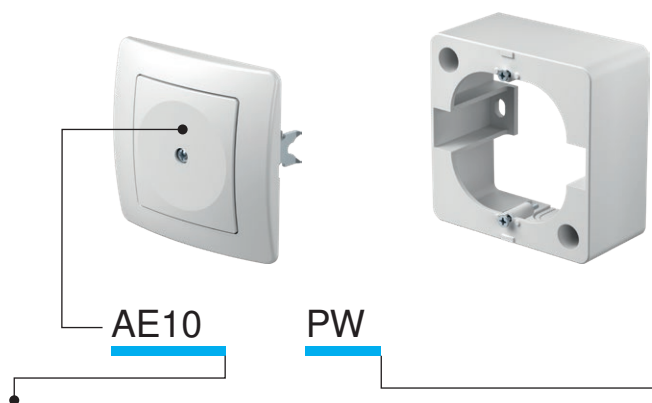

Iloji type	përshkrimi description	ngjyra colour
AE10	FALSO BLANK	<input type="checkbox"/> PW e bardhë polare polar white
AE20	KUTI LIDHJEJE 3P+N+E 5X4 mm ² CONNECTION BOX 3P+N+E 5X4mm ²	<input type="checkbox"/> IW e bardhë fildishi ivory white
AE30	KUTI ME MONTIM NË SIPËRFAQE NO 1 SURFACE MOUNT BOX	<input type="checkbox"/> ES e argjendtë elox elox silver
⋮	⋮	<input type="checkbox"/> CO termoset i bardhë white thermoset
⋮	⋮	<input type="checkbox"/> NB e zezë mesnate night black

FALSO

- për mbushjen e hapësirave boshe

BLANK

- for filling up empty spaces

- AE10PW
- AE10IW
- AE10NB
- AE10ES
- AE10CO

KUTI LIDHJEJE 5 POLARE 3P+N+E 5X4 mm²

- kuti lidhjeje 3P+N+E
- 16 A 400V~
- në përputhje me VDE 0606-1:2000
- kontaktet e vidave 1,5-4mm²

CONNECTION BOX 5POLE 3P+N+E 5x4mm²

- 3P+N+E connection box
- 16A 400V~
- in accordance with VDE 0606-1:2000
- screw contacts 1.5-4mm²

- AE20PW
- AE20IW

KUTI ME MONTIM NË SIPËRFAQE 1

- kuti me montim në sipërfaqe

SURFACE MOUNT BOX 1

- surface mounting box

- AE30PW
- AE30IW

KUTI SIPËRFAQËSORE PËR PRIZË DYSHE EKONOMIK

- kuti me montim në sipërfaqe

SURFACE MOUNT BOX FOR EKONOMIK DOUBLE SOCKET

- surface mounting box

- AE31PW

MBROJTJE PËR MUR



- AE50PW
- AE50TS

- mbron sipërfaqen rrotull prizës ose çelësit

WALL PROTECTION

- protects surface around socket or switch

MBROJTJE PËR FËMIJËT KS



- AE51PW
- AE51IW

- insert shtesë KS për mbrojtje për fëmijët

CHILD PROTECTION KS

- KS additional child protection insert - shuttered live contacts

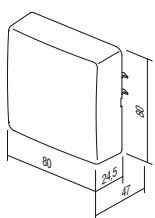

AE20

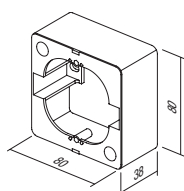

AE30

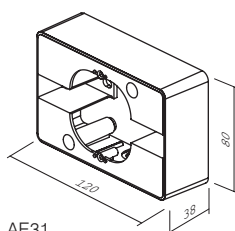

AE31

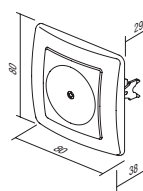

AE10

S U R R O U N D S O E



OE10



PW

Iloji type	përshkrimi description	ngjyra colour
OE10	RRETHUES EKONOMIK 1 SURROUND EKONOMIK 1	<input type="checkbox"/> PW e bardhë polare polar white
OE20	RRETHUES EKONOMIK 2 HORIZONTAL SURROUND EKONOMIK 2 HORIZONTAL	<input type="checkbox"/> IW e bardhë fildishi ivory white
OE30	RRETHUES EKONOMIK 3 HORIZONTAL SURROUND EKONOMIK 3 HORIZONTAL	<input type="checkbox"/> ES e argjendtë elox elox silver
⋮	⋮	<input type="checkbox"/> CO termoset i bardhë white thermoset
⋮	⋮	<input type="checkbox"/> NB e zezë mesnate night black

RRETHUES EKONOMIK 1



- OE10PW
- OE10IW
- OE10ES
- OE10CO
- OE10NB

- rrethues dekorativ me 1 pozicion
- në përputhje me EN 60669-1

SURROUND EKONOMIK 1
- decorative surround 1-gang
- in accordance with EN 60669-1

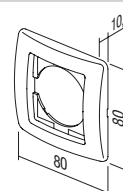

RRETHUES EKONOMIK 2 HORIZONTAL



- OE20PW
- OE20IW
- OE20ES
- OE20CO
- OE20NB

- rrethues dekorativ me 2 pozicione horizontal
- në përputhje me EN 60669-1

SURROUND EKONOMIK 2 HORIZONTAL
- decorative surround 2-gang horizontal
- in accordance with EN 60669-1

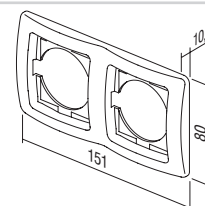

RRETHUES EKONOMIK 2 VERTIKAL



- OE21PW
- OE21IW
- OE21ES
- OE21CO
- OE21NB

- rrethues dekorativ me 2 pozicione vertikal
- në përputhje me EN 60669-1

SURROUND EKONOMIK 2 VERTICAL
- decorative surround 2-gang vertical
- in accordance with EN 60669-1

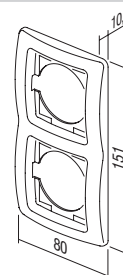

RRETHUES EKONOMIK 3 HORIZONTAL



- OE30PW
- OE30IW
- OE30ES
- OE30CO
- OE30NB

- rrethues dekorativ me 3 pozicione horizontal
- në përputhje me EN 60669-1

SURROUND EKONOMIK 3 HORIZONTAL
- decorative surround 3-gang horizontal
- in accordance with EN 60669-1

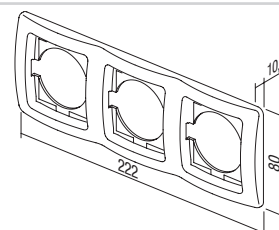



- OE31PW
- OE31IW
- OE31ES
- OE31CO
- OE31NB

RRETHUES EKONOMIK 3 VERTIKAL

- rrethues dekorativ me 3 pozicione vertikal
- në përputhje me EN 60669-1

SURROUND EKONOMIK 3 VERTIKAL

- decorative surround 3-gang vertical
- in accordance with EN 60669-1

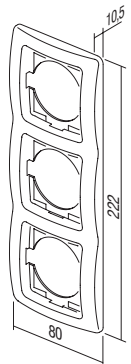

- OE40PW
- OE40IW
- OE40ES
- OE40NB

RRETHUES EKONOMIK 4 HORIZONTAL

- rrethues dekorativ me 4 pozicione horizontal
- në përputhje me EN 60669-1

SURROUND EKONOMIK 4 HORIZONTAL

- decorative surround 4-gang horizontal
- in accordance with EN 60669-1

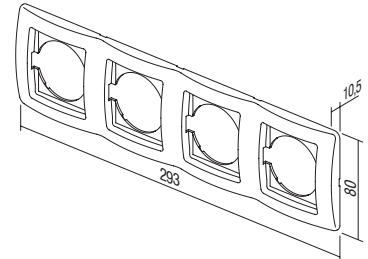

- OE41PW
- OE41IW
- OE41ES
- OE41NB

RRETHUES EKONOMIK 4 VERTIKAL

- rrethues dekorativ me 4 pozicione vertikal
- në përputhje me EN 60669-1

SURROUND EKONOMIK 4 VERTIKAL

- decorative surround 4-gang vertical
- in accordance with EN 60669-1

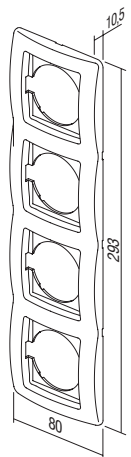

- OE50PW
- OE50IW
- OE50ES
- OE50NB

RRETHUES EKONOMIK 5 HORIZONTAL

- rrethues dekorativ me 5 pozicione horizontal
- në përputhje me EN 60669-1

SURROUND EKONOMIK 5 HORIZONTAL

- decorative surround 5-gang horizontal
- in accordance with EN 60669-1

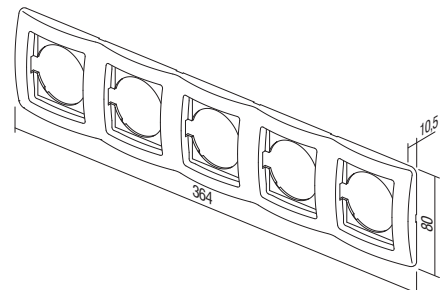

KORNIZA DEKORATIVE ME NGJYRA /
 COLOR DECORATIVE FRAMES



OE90GR E GJELBËR /
 GREEN
 OE90BL BLU /
 BLUE
 OE90VO VJOLLÇË /
 VIOLET
 OE90PI ROZË /
 PINK
 OE90RD E KUQE /
 RED

OE90YL E VERDHË /
 YELLOW
 OE90WH E BARDHË /
 WHITE
 OE90GY GRI /
 GREY
 OE90BK E ZEZË /
 BLACK

OE90MB MET. BLU /
 MET. BLUE
 OE90BZ BRONZ /
 BRONZE
 OE90CR E ARGJENDTË /
 SILVER
 OE90GO E ARTË /
 GOLD





fontana



TEM





SF10

PW

TI

Iloji type	përshkrimi description	të dhënat teknike technical data	ngjyra colour	të dhënat opsionale 1 optional data 1
SF10	ÇELËS ME 1 DREJTIM SWITCH 1WAY	IP44 10AX 250V~	<input type="checkbox"/> PW e bardhë-mat white-mat	TI llambë neoni+tregues neon lamp+indication
SF11	BUTON MESHTYRJE ME 1 DREJTIM PUSH BUTTON 1WAY	IP44 10A 250V~	<input checked="" type="checkbox"/> GY gri-mat grey-mat	
SF20	ÇELËS 2 POLAR SWITCH 2POLE	IP44 10AX 250V~		
:	:	:		
:	:	:		

ÇELËS ME 1 DREJTIM IP44 10 A X 250 V~



- SF10PW
- SF10GY

- 10 A X 250 V~, Iloji SF10
- në përputhje me EN 60669-1
- kontakte për futje telash 1,5-2,5 mm²
SWITCH 1WAY IP44 10AX 250V~
- 10AX 250V~, type SF10
- in accordance with EN 60669-1
- plug-in contacts 1.5-2.5mm²



ÇELËS ME 1 DREJTIM IP44 10 A X 250 V~ __ TI



- SF10PWTI
- SF10GYTI

- TI tregues+llambë neoni
- 10 A X 250 V~, Iloji SF10
- në përputhje me EN 60669-1
- kontakte për futje telash 1,5-2,5 mm²
SWITCH 1WAY IP44 10AX 250V~ __ TI
- TI indicator+neon lamp
- 10AX 250V~, type SF10
- in accordance with EN 60669-1
- plug-in contacts 1.5-2.5mm²



BUTON ME SHTYRJE ME 1 DREJTIM IP44 10 A 250 V~ __ TI



- SF11PWTI
- SF11GYTI

- TI tregues+llambë neoni
- 10A 250 V~, Iloji SF11
- në përputhje me EN 60669-1
- kontakte për futje telash 1,5-2,5 mm²
PUSH BUTTON 1WAY IP44 10A 250V~ __ TI
- TI indicator+neon lamp
- 10A 250V~, type SF11
- in accordance with EN 60669-1
- plug-in contacts 1.5-2.5mm²















ÇELËS ME 2 DREJTIME IP44 10 A X 250 V~



- SF20PW
- SF20GY

- 10 A X 250 V~, Iloji SF20
- në përputhje me EN 60669-1
- kontakte për futje telash 1,5-2,5 mm²
SWITCH 2POLE IP44 10AX 250V~
- 10AX 250V~, type SF20
- in accordance with EN 60669-1
- plug-in contacts 1.5-2.5mm²



	<input type="checkbox"/> SF50PW <input checked="" type="checkbox"/> SF50GY	<p>ÇELËS ME 2 POZICIONE 1 DREJTIM IP44 10 A X 250 V~</p> <ul style="list-style-type: none"> - 10 A X 250 V~, Iloji SF50 - në përputhje me EN 60669-1 - kontakte për futje telash 1,5-2,5 mm² <p><i>SWITCH 2GANG-1WAY IP44 10AX 250V~</i></p> <ul style="list-style-type: none"> - 10AX 250V~, type SF50 - in accordance with EN 60669-1 - plug-in contacts 1.5-2.5mm² 	
	<input type="checkbox"/> SF51PW <input checked="" type="checkbox"/> SF51GY	<p>BUTON ME SHYTPJE ME 2 POZICIONE - 1 DREJTIM IP44 10A 250 V~</p> <ul style="list-style-type: none"> - 10A 250 V~, Iloji SF51 - në përputhje me EN 60669-1 - kontakte për futje telash 1,5-2,5 mm² <p><i>PUSH BUTTON 2GANG-1WAY IP44 10A 250V~</i></p> <ul style="list-style-type: none"> - 10A 250V~, type SF51 - in accordance with EN 60669-1 - plug-in contacts 1.5-2.5mm² 	
	<input type="checkbox"/> SF60PW <input checked="" type="checkbox"/> SF60GY	<p>ÇELËS ME 2 DREJTIME IP44 10 A X 250 V~</p> <ul style="list-style-type: none"> - 10 A X 250 V~, Iloji SF60 - në përputhje me EN 60669-1 - kontakte për futje telash 1,5-2,5 mm² <p><i>SWITCH 2WAY IP44 10AX 250V~</i></p> <ul style="list-style-type: none"> - 10AX 250V~, type SF60 - in accordance with EN 60669-1 - plug-in contacts 1.5-2.5mm² 	
	<input type="checkbox"/> SF60PWTI <input checked="" type="checkbox"/> SF60GYTI	<p>ÇELËS ME 2 DREJTIME IP44 10 A X 250 V~ __ TI</p> <ul style="list-style-type: none"> - TI tregues+llambë neoni - 10 A X 250 V~, Iloji SF60 - në përputhje me EN 60669-1 - kontakte për futje telash 1,5-2,5 mm² <p><i>SWITCH 2WAY IP44 10AX 250V~ __ TI</i></p> <ul style="list-style-type: none"> - TI indicator+neon lamp - 10AX 250V~, type SF60 - in accordance with EN 60669-1 - plug-in contacts 1.5-2.5mm² 	
	<input type="checkbox"/> SF63PW <input checked="" type="checkbox"/> SF63GY	<p>ÇELËS ME 2 DREJTIME DYSH IP44 10 A X 250 V~</p> <ul style="list-style-type: none"> - 10 A X 250 V~, Iloji SF63 - në përputhje me EN 60669-1 - kontakte për futje telash 1,5-2,5 mm² <p><i>SWITCH 2WAY DOUBLE IP44 10AX 250V~</i></p> <ul style="list-style-type: none"> - 10AX 250V~, type SF63 - in accordance with EN 60669-1 - plug-in contacts 1.5-2.5mm² 	
	<input type="checkbox"/> SF70PW <input checked="" type="checkbox"/> SF70GY	<p>ÇELËS NDËRMJETËS IP44 10 A X 250 V~</p> <ul style="list-style-type: none"> - 10 A X 250 V~, Iloji SF70 - në përputhje me EN 60669-1 - kontakte për futje telash 1,5-2,5 mm² <p><i>SWITCH INTERMEDIATE IP44 10AX 250V~</i></p> <ul style="list-style-type: none"> - 10AX 250V~, type SF70 - in accordance with EN 60669-1 - plug-in contacts 1.5-2.5mm² 	

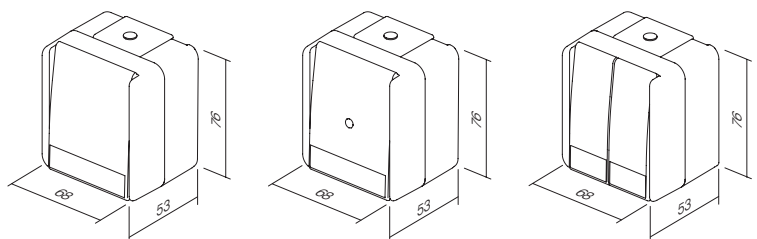



VF10

PW

Iloji type	përshkrimi description	të dhënat teknike technical data	ngjyra colour
VF10	PRIZË SCHUKO+KAPAK SOCKET SCHUKO+COVER	IP44 2P+E 16A 250V~	<input type="checkbox"/> PW e bardhë-mat white-mat <input type="checkbox"/> GY gri-mat grey-mat

PRIZË SCHUKO+KAPAK IP44 2P+E 16 A 250 V~



- VF10PW
- VF10GY

- kontaktet e vidave 1,5-2,5 mm²
- 2P+E schuko+kapak
- 16 A 250 V~, Iloji VF10
- në përputhje me EN 60884-1, CEE7

SOCKET SCHUKO+COVER IP44 2P+E 16A 250V~

- screw contacts 1.5-2.5mm²
- 2P+E schuko+cover
- 16A 250V~, type VF10
- in accordance with EN 60884-1, CEE7



PRIZË SCHUKO+KAPAK IP44 2P+E 16 A 250 V~ BV



- VF12PW
- VF12GY

- BV kontakte për futje telash 1,5-2,5 mm²
- 2P+E schuko+kapak
- 16 A 250 V~, Iloji VF12
- në përputhje me EN 60884-1, CEE7

SOCKET SCHUKO+COVER IP44 2P+E 16A 250V~ BV

- BV plug-in contacts 1.5-2.5mm²
- 2P+E schuko+cover
- 16A 250V~, type VF12
- in accordance with EN 60884-1, CEE7

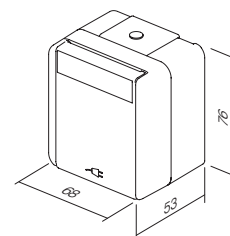

VF10
VF12

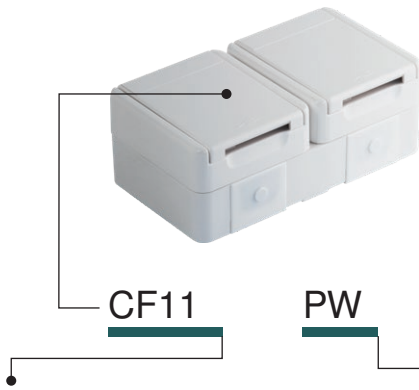

Iloji type	përshkrimi description	të dhënat teknike technical data	ngjyra colour
CF10	PRIZË SET SCHUKO DYSHE HORIZ SOCKET SET SCHUKO DOUBLE HORIZ	2x 2P+E 16A 250V~ IP44	<input type="checkbox"/> PW e bardhë-mat white-mat
CF11	PRIZË SET SCHUKO DYSHE VERT SOCKET SET SCHUKO DOUBLE VERT	2x 2P+E 16A 250V~ IP44	<input checked="" type="checkbox"/> GY gri-mat grey-mat
CF12	PRIZË SCH+ÇELËS 2 DREJTIME HORIZ SOCKET SCH+SWITCH 2WAY HORIZ	16A + 10A 250V~ IP44	
⋮	⋮	⋮	
⋮	⋮	⋮	

SET PRIZË SCHUKO DYSHE HORIZONTALE IP44 2x 2P+E 16 A 250 V~



- CF10PW
- CF10GY

- kontaktet e vidave 1,5-2,5 mm²
- 2x 2P+E schuko+kapak horizontale
- 16 A 250 V~, Iloji CF10
- në përputhje me EN 60884-1, CEE7

SOCKET SET SCHUKO DOUBLE
HORIZONTAL IP44 2x 2P+E 16A 250V~
- screw contacts 1.5-2.5mm²
- 2x 2P+E schuko+cover horizontal
- 16A 250V~, type CF10
- in accordance with EN 60884-1, CEE7



SET PRIZË SCHUKO DYSHE VERTIKALE IP44 2x 2P+E 16 A 250 V~



- CF11PW
- CF11GY

- kontaktet e vidave 1,5-2,5 mm²
- 2x 2P+E schuko+kapak vertikale
- 16 A 250 V~, Iloji CF11
- në përputhje me EN 60884-1, CEE7

SOCKET SET SCHUKO DOUBLE VERTICAL
IP44 2x 2P+E 16A 250V~
- screw contacts 1.5-2.5mm²
- 2x 2P+E schuko+cover vertical
- 16A 250V~, type CF11
- in accordance with EN 60884-1, CEE7



PRIZË SCH+SET ÇELËS 2 DREJTIME HORIZONTAL IP44 16 A + 10 A X 250 V~



- CF12PW
- CF12GY

- vidë (priza), futje (çelësi) kontaktet 1,5-2,5 mm²
- 2P+E schuko+kapak + çelës horizontal 2 drejtime
- 16 A + 10 A X 250 V~, Iloji CF12
- në përputhje me standardet EN 60884-1, CEE7, EN 60669-1

SOCKET SCH+SWITCH SET 2WAY
HORIZONTAL IP44 16A + 10AX 250V~
- screw (socket), plug-in (switch)
contacts 1.5-2.5mm²
- 2P+E schuko+cover + switch 2-way horizontal
- 16A + 10AX 250V~, type CF12
- in accordance with EN 60884-1, CEE7, EN 60669-1



PRIZË SCH+SET ÇELËS 2 DREJTIME VERTIKAL IP44 16 A + 10 A X 250 V~



- CF13PW
- CF13GY

- vidë (priza), futje (çelësi)
- kontakte për futje telash 1,5-2,5 mm²
- 2P+E schuko+kapak + çelës 2 drejtime vertikal
- 16 A + 10 A X 250 V~, lloji CF13
- në përputhje me standardet EN 60884-1, CEE7, EN 60669-1

SOCKET SCH+SWITCH 2WAY SET VERTICAL IP44 16A + 10AX 250V~

- screw (socket), plug-in (switch)
- contacts 1.5-2.5mm²
- 2P+E schuko+cover + switch 2-way vertical
- 16A + 10AX 250V~, type CF13
- in accordance with EN 60884-1, CEE7, EN 60669-1



SET PRIZË SCHUKO DYSHE HORIZONTALE IP44 2x 2P+E 16 A 250 V~ BV



- CF14PW
- CF14GY

- BV kontakte për futje telash 1,5-2,5 mm²
- 2x 2P+E schuko+kapak horizontale
- 16 A 250 V~, lloji CF14
- në përputhje me EN 60884-1, CEE7

SOCKET SET SCHUKO DOUBLE HORIZONTAL IP44 2x 2P+E 16A 250V~ BV

- BV plug-in contacts 1.5-2.5mm²
- 2x 2P+E schuko+cover horizontal
- 16A 250V~, type CF14
- in accordance with EN 60884-1, CEE7



SET PRIZË SCHUKO DYSHE VERTIKALE IP44 2x 2P+E 16 A 250 V~ BV



- CF15PW
- CF15GY

- BV kontakte për futje telash 1,5-2,5 mm²
- 2x 2P+E schuko+kapak vertikale
- 16 A 250 V~, lloji CF15
- në përputhje me EN 60884-1, CEE7

SOCKET SET SCHUKO DOUBLE VERTICAL IP44 2x 2P+E 16A 250V~ BV

- BV plug-in contacts 1.5-2.5mm²
- 2x 2P+E schuko+cover vertical
- 16A 250V~, type CF15
- in accordance with EN 60884-1, CEE7



PRIZË+SET ÇELËS SCH+2 DREJTIME HORIZONTAL IP44 16 A + 10 A X 250 V~ BV



- CF16PW
- CF16GY

- BV kontakte për futje telash 1,5-2,5 mm²
- 2P+E schuko+kapak + çelës 2 drejtime horizontalisht
- 16 A + 10 A X 250 V~, lloji CF16
- në përputhje me standardet EN 60884-1, CEE7, EN 60669-1

SOCKET+SWITCH SET SCH+2WAY HORIZONTAL IP44 16A + 10AX 250V~ BV

- BV plug-in contacts 1.5-2.5mm²
- 2P+E schuko+cover + switch 2-way horizontal
- 16A + 10AX 250V~, type CF16
- in accordance with EN 60884-1, CEE7, EN 60669-1



PRIZË SCH+SET ÇELËS 2 DREJTIME VERTIKAL IP44 16 A + 10 A X 250 V~ BV



- CF17PW
- CF17GY

- BV kontakte për futje telash 1,5-2,5 mm²
- 2P+E schuko+kapak + çelës 2 drejtime vertikal
- 16 A + 10 A X 250 V~, lloji CF17
- në përputhje me standardet EN 60884-1, CEE7, EN 60669-1

SOCKET SCH+SWITCH 2WAY SET VERTICAL IP44 16A + 10AX 250V~ BV

- BV plug-in contacts 1.5-2.5mm²
- 2P+E schuko+cover + switch 2-way vertical
- 16A + 10AX 250V~, type CF17
- in accordance with EN 60884-1, CEE7, EN 60669-1



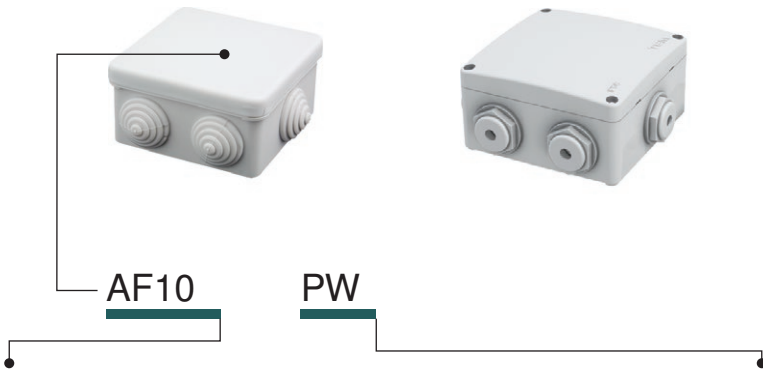

Iloji type	përshkrimi description	të dhënat teknike technical data	ngjyra colour
AF10	KUTI SHPËRNDARJEJE DISTRIBUTION BOX	IP44 RN01	<input type="checkbox"/> PW e bardhë-mat white-mat
AF20	KUTI SHPËRNDARJEJE DISTRIBUTION BOX	IP55 NDO1	<input type="checkbox"/> GY gri-mat grey-mat

KUTI SHPËRNDARJEJE IP44 RN01



- AF10PW
- AF10GY

- kuti shpërndarjeje me montim në sipërfaqe IP44
- 16 A 400V~
- në përputhje me standardet IEC/EN 60670-1, IEC/EN 60670-22

DISTRIBUTION BOX IP44 RN01

- surface mounting distribution box IP44
- 16A 400V~
- in accordance with IEC/EN 60670-1, IEC/EN 60670-22

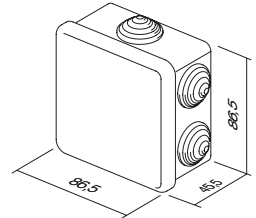

KUTI SHPËRNDARJEJE IP55 NDO1



- AF20PW
- AF20GY

- kuti lidhjeje me montim në sipërfaqe IP55
- xhuntot përfshihen
- në përputhje me standardet IEC/EN 60670-1, IEC/EN 60670-22

DISTRIBUTION BOX IP55 NDO1

- surface mounting connection box IP55
- glands included
- in accordance with IEC/EN 60670-1, IEC/EN 60670-22

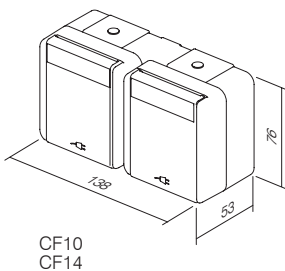
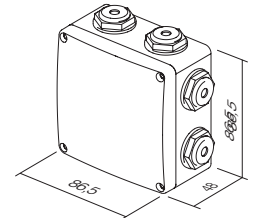

CF10
CF14

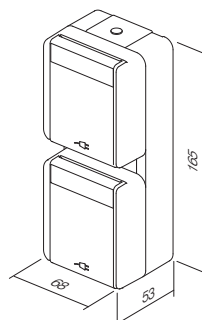

CF11
CF15

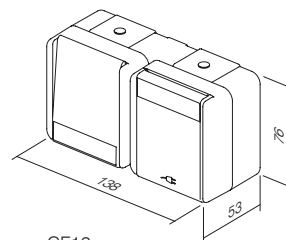

CF12
CF16

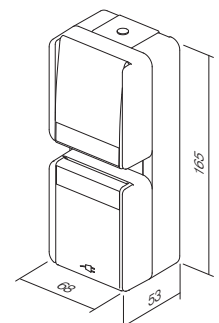

CF13
CF17

kodi	Përshkrimi i produktit	faqe
ÇELËSAT SM		
SM10	ÇELËS ME 1 DREJTIM 16 AX 250 V- 1M	50
SM11	BUTON ME SHYTPJE ME 1 DREJTIM 16 A 250 V- 1M	50
SM12	ÇELËS ME 1 DREJTIM 20 A 250 V- 1M	50
SM20	ÇELËS 2-POLAR 16 AX 250 V- 1M	50
SM40	MBYLLËSE ÇELËSI 1-0-2 16 AX 250 V- 1M	51
SM41	MBYLLËSE BUTONI ME SHYTPJE 1-0-2 16 A 250 V- 1M	51
SM60	ÇELËS ME 2 DREJTIME 16 AX 250 V- 1M	51
SM61	BUTON ME SHYTPJE ME 2 DREJTIME 16 A 250 V- 1M	51
SM70	ÇELËS NDËRMJETËS 16 AX 250 V- 1M	51
SM10--	ÇELËS ME 1 DREJTIM 16 AX 250 V- 1M	52
SM10--IN	ÇELËS ME 1 DREJTIM 16 AX 250 V- 1M IN	52
SM11--	BUTON ME SHYTPJE ME 1 DREJTIM 16 A 250 V- 1M	52
SM11--IN01	BUTON ME SHYTPJE ME 1 DREJTIM 16 A 250 V- 1M IN 01	52
SM11--IN02	BUTON ME SHYTPJE ME 1 DREJTIM 16 A 250 V- 1M IN 02	53
SM20--NT03	ÇELËS 2-POLAR 16 AX 250 V- 1M NT 03	53
SM20--IN	ÇELËS 2-POLAR 16 AX 250 V- 1M IN	53
SM40--NT10	MBYLLËSE ÇELËSI 1-0-2 16 AX 250 V- 1M NT 10	53
SM41--NT10	MBYLLËSE BUTONI ME SHYTPJE 1-0-2 16 A 250 V- 1M __ NT 10	53
SM60--	ÇELËS ME 2 DREJTIME 16 AX 250 V- 1M	53
SM61--	BUTON ME SHYTPJE ME 2 DREJTIME 16 A 250 V- 1M	54
SM62--CD	BUTON ME SHYTPJE ME 2 DREJTIME ME KORDON 16 A 250 V- 1M __ CD	54
SM70--	ÇELËS NDËRMJETËS 16 AX 250 V- 1M	54

kodi	Përshkrimi i produktit	faqe
BUTONAT TM		
TM11--	BUTON 1M	55
TM11--IN	BUTON 1M IN	55
TM12--	BUTON 2M	55
TM12--IN	BUTON 2M IN	55
TM13--IL	BUTON 2M ME KAPAK ME MBISHKRIM	56
TM15--	BUTON 1M 2-POLAR	56
TM21--	FALSO 1M	56
TM22--	FALSO 2M	56
TM31--	DALJE PËR KABLLO 1M	56

kodi	Përshkrimi i produktit	faqe
SINJALIZIMI IA		
IA100R	LLAMBË NEONI 230 V- 0,34 W	58
IA20--	SINJALIZIMI LED 230 V AC/DC 0,4 W	58
IA21--	SINJALIZIMI LED 24 V AC/DC 0,2 W	58
IA22--	SINJALIZIMI LED 12V AC/DC 0,10 W	58
IA50	QARK RC 250 V	58

kodi	Përshkrimi i produktit	faqe
PRIZAT VM		
VM10--	PRIZË SCHUKO+KS 2P+E 16 A 250 V- 2M	60
VM11--	PRIZË SCHUKO+KS+KAPAK 2P+E 16 A 250 V- 2M	60
VM20--	PRIZË EVROPIANE+KS 2P 10 A 250 V- 1M	61
VM40--	PRIZË FRANCEZE+KS 2P+E 16 A 250 V- 2M	61
VM41--	PRIZË FRANCEZE+KS+KAPAK 2P+E 16 A 250 V- 2M	61
VM30--	PRIZË ITALIANE P17/11+KS 2P+E 16 A 250 V- 1M	61
VM31--	PRIZË SCHUKO/ITALIANE P17/11+KS 2P+E 16 A 250 V- 2M	61
VM32--	PRIZË SCHUKO/ITALIANE P30+KS 2P+E 16 A 250 V- 2M	62
VM33--	PRIZË ITALIANE P11+KS 2P+E 10 A 250 V- 1M	62
VM21--	PRIZË EVROPIANE/AMERIKANE+KS 2P 16 A 250 V- 1M	62
VM52--	PRIZË BRITANIKE BS 1363+KS 2P+E 13 A 250 V- 2M	62
VM55--	PRIZA MULTISTANDARDE+KS 2P+E 13A 250V- 2M	62
VM80	MBROJTËS NGA MBITENSIONI MPE MINI 275 V/50 Hz	62

kodi	Përshkrimi i produktit	faqe
KOMUNIKIMET KM		
KM10--	PRIZË TV BAZË 0 dB 1M	64
KM20--	PRIZË TV BAZË 0 dB 2M	64
KM11--	PRIZË TV ME KAPAK FUNDOR 1 dB 1M	64
KM12--	PRIZË TV KALUESE 10 dB 1M	64
KM15--	PRIZË SAT BAZË 0 dB 1M	65
KM24--	PRIZË SAT BAZË 0 dB 2M	65
KM16--	PRIZË SAT ME KAPAK FUNDOR 1 dB 1M	65
KM19--	PRIZË R BAZË 0 dB 1M	65
KM29--	PRIZË R BAZË 0 dB 2M	65
KM25--	PRIZË SAT-TV ME KAPAK FUNDOR 1 dB 2M	65
KM22--	PRIZË AUDIO 2xRCA 1M	66
KM23--	PRIZË AUDIO ALTOPARLANTË 1M	66
KM26--	PRIZË AUDIO ALTOPARLANTË 2M	66
KM30--	PRIZË TEL LT RJ11 6/4 1M	67
KM31--	PRIZË TEL BT SEC 6/6 1M	67
KM36--	PRIZË TEL KS RJ11 6/4 1M	67
KM37--	PRIZË CAT5e KS RJ45 8/8 1M	67
KM35--	PËRSHTATËS KS 1M	67
KM38--	PËRSHTATËS KS ME MBROJTJE NGA PLUHURI 1M	67
KM39--	PRIZË CAT6 SCH KS RJ45 8/8 1M	68
KM50--	PËRSHTATËS KS UNIVERSAL 1M	68
KM40--	PËRSHTATËS PD 1M	68
KM43--	PËRSHTATËS PD ME MBROJTJE NGA PLUHURI 1M	68
KM46--	PËRSHTATËS R&M 1M	68
KM52--	PËRSHTATËS R&M CAT6A 1M	68
KM47--	PËRSHTATËS R&M ME MBROJTJE NGA PLUHURI 1M	69
KM53--	PËRSHTATËS R&M CAT6A ME MBROJTJE NGA PLUHURI 1M	69
KM45--	PËRSHTATËS LK 1M	70
KA26	PËRSHTATËS NEXANS/SCHRACK 2M	70
KM48--	PËRSHTATËS AT&T SYSTIMAX ME MBROJTJE NGA PLUHURI 1M	70
KM51--	PRIZË USB LLOJIT A 1M	70

kodi	Përshkrimi i produktit	faqe
AKSESORËT E KOMUNIKIMIT KA		
KA10	KONEKTOR KS RJ11 RJ11 6/4	71
KA11	KONEKTOR KS CAT5e RJ45 8/8	71
KA12	KONEKTOR KS CAT5eS RJ45 8/8	71
KA15	KONEKTOR KS RJ45 SCHRACK RJ45 8/8	71
KA16	KONEKTOR KS RJ45 SCHRACK RJ45 8/8	71
KA17	KONEKTOR KS CAT6a SCHRACK RJ45 8/8	71
KA18	KONEKTOR KS RJ45 SCHRACK RJ45 8/8	72
KA27	KONEKTOR KS HDMI	72
KA28	KABLLOJA KS HDMI	72

kodi	Përshkrimi i produktit	faqe
LIDHJET ELEKTRONIKE EM		
EM12--	REOSTAT RROTULLUES/2 DREJTIME RL 300 W 1M	73
EM13--	REOSTAT RROTULLUES/2 DREJTIME LED 60 W 1M	73
EM14--	REOSTAT RROTULLUES/2 DREJTIME LED 180 W 1M	74
EM15--	REOSTAT RROTULLUES R 250 W 1M	74
EM16--	1-10 V ÇELËSI RROTULLUES ME DY DREJTIME I REOSTATIT	75
EM23	REOSTAT ME MONTIM NË KUTI R (250 W), (RC, RL 200VA)	75
EM17	MODULI I KONTROLLIT MZC për EM18	76
EM18	REOSTAT ME MONTIM NË KUTI LED 250 W	76
EM19	REOSTAT ME MONTIM NË KUTI DC LED 96 W	77
EM25--	ÇELËS/REOSTAT UNIVERSAL RLC 0-300 W 2M	78
EM26--	NJËSI KONTROLLI ME BUTON ME SHYTPJE 2M	81
EM27	FILTËR FREKUJENCE	81
EM25PPOL20	SET ÇELËS/REOSTAT RLC 0-300 W 2M PP OL20	81
EM31--	ÇELËS IR 5 A 230 V- 1M	82
EM32--	ÇELËS IR 5 A 230 V- 2M	82
EM37--	TERMOSTAT BAZË 6 A 230 V - 2M	84
EM38--	TERMOSTATI I NGROHJES 5(2)A 230V- 2M	85
EM39--	TERMOSTAT NGROHJEJE/FTOHJEJE 3(1,5)A 230V- 2M	85
NM39	KORNIZË MONTIMI ME VIDA PËR TERMOSTATE FANTINI COSMI 3M	86
EM40--	ÇELËS KARTE PËR KURSIMIT E ENERGJISË 3 A 250 V- 3M	86
EM47	KARTË ISO	86
EM44--	ÇELËS KARTE PËR KURSIMI TË ENERGJISË RF HF 13,56 MHz 3M	87
EM49	NJËSI KONTROLLI E KURSIMIT TË ENERGJISË 2x16 A 250 V-	87
EM45	SHPËRNDARËS SPL-1	87
EM60--	PRIZË PËR RROJË 230 V-/120 V- 3M	88
EM67--	NJËSI USB E FURNIZIMI ME ENERGJI 5 V 2,4 A 1M	88
EM68--	NJËSI USB E FURNIZIMI ME ENERGJI 5 V 3,0 A	89
EM55	DRITË EMERGJENCE LED 250 V- 0,90 W, NiCd 3h 7M	89
EM57	DRITË EMERGJENCE 230 V- 50 Hz 0,5 W, NiMH 2h 2M	89
EM50--	NJËSI LED NJËNGJYRËSHE AMBIENT 250 V- 0,8 W 2M	90
EM51--	LLAMBË LED ME DY NGJYRA 250 V- 2 x 0,4 W 2M	90
EM52--	LLAMBË LED 3D ME DY NGJYRA 250 V- 2 x 0,4 W 2M	90
EM71--	ÇELËS ME GJURMË GISHTI BIOPASS 2M	91
EM82--	KOHËMATËS ME SHUMË FUNKSIONE EM82	92
EM80--	ÇELËS, PA PREKJE 10 A 240 V-	94
EM81--	ÇELËS, PA PREKJE	94
EM90--	SINJALIZUES 8 VA 230 V-1M	95
EM91--	SINJALIZUES 8 VA 12 V-1M	95
EM92--	ZILE 8 VA 230 V-1M	95
EM93--	ZILE 8 VA 12V-1M	95
EM94--	ZILE ELEKTRONIKE 230V- 6mA rms 1M	96
EM95--	KONTROLL VOLUMI 100 V LINJË AUDIO 35 W 2M	96
EM96--	KONTROLL VOLUMI 4-8 Ω 35 W 2M	96

kodi	Përshkrimi i produktit	faqe
SETI CM		
CM10--	SET PRIZASH 2x SCHUKO 2P+E 16 A 250 V- 4M	97
CM11--	SET PRIZASH 3x SCHUKO 2P+E 16 A 250 V- 7M	97
CM15	SET LIDHJEJE 3x1,5 mm ² 1M	98
CM16	SET LIDHJEJE 3x2,5 mm ² 2M	98
CM17	SET VIDASH 3,5x20	98
CM18	SET VIDASH 3,5x35	98
CM19	SET VIDASH 3,5x50	98
CM22--	SET ÇELËSASH IP44 2M	98
CM23--	SET PRIZASH IP44 2M	98
CM25--OL	SET ÇELËSASH PËR BANJË 3x20 A 250 V- 4M OL	98
CM25--OS	SET ÇELËSASH PËR BANJË 3x20 A 250 V- 4M OS	98
NM41	SET KORNIZË MONTIMI PËR BANJË 4M	99
OL41--	SET KAPAKU MBULUES LINE PËR BANJË	99
OS41--	SET KAPAKU MBULUES SOFT PËR BANJË	99
PROGRAMI ANTIBAKTERIAL AW		
TM11AW	BUTON 1M	101
TM11AWIN	BUTON 1M IN	101
TM12AW	BUTON 2M	101
TM12AWIN	BUTON 2M IN	101
TM21AW	FALSO 1M	101
TM22AW	FALSO 2M	101
VM10AW	PRIZË SCHUKO+KS 2P+E 16 A 250 V- 2M	102
VM11AW	PRIZË SCHUKO+KS+KAPAK 2P+E 16 A 250 V- 2M	102
VM20AW	PRIZË EVROPIANE+KS 2P 10 A 250 V- 1M	102
KM11AW	PRIZË TV ME KAPAK FUNDOR 1 dB 1M	102
KM35AW	PËRSHTATËS KS 1M	102
OS20AW	KAPAK MBULUES SOFT 2M	103
OS24AW	KAPAK MBULUES SOFT 2x2M	103
OS26AW	KAPAK MBULUES SOFT 3x2M	103
OS30AW	KAPAK MBULUES SOFT 3M	103
OS40AW	KAPAK MBULUES SOFT 4M	103
OS70AW	KAPAK MBULUES SOFT 7M	103
KAPAKËT MBULUES PURE OP		
OP20--	KAPAK MBULUES PURE 2M	106
OP24--	KAPAK MBULUES PURE 2x2M	106
OP26--	KAPAK MBULUES PURE 3x2M	106
OP28--	KAPAK MBULUES PURE 4x2M	106
OP30--	KAPAK MBULUES PURE 3M	107
OP40--	KAPAK MBULUES PURE 4M	107
OP70--	KAPAK MBULUES PURE 7M	107
OP13--	KAPAK MBULUES PURE 1/3M	107
OP23--	KAPAK MBULUES PURE 2/3M	107
KAPAKËT MBULUES LINE OL		
OL20--	KAPAK MBULUES LINE 2M	110
OL24--	KAPAK MBULUES LINE 2x2M	110
OL26--	KAPAK MBULUES LINE 3x2M	110
OL28--	KAPAK MBULUES LINE 4x2M	110
OL29--	KAPAK MBULUES LINE 5x2M	110
OL30--	KAPAK MBULUES LINE 3M	111
OL40--	KAPAK MBULUES LINE 4M	111
OL70--	KAPAK MBULUES LINE 7M	111
OL71--	KAPAK MBULUES LINE 2x7M	111
OL10--	KAPAK MBULUES LINE 1/2M	111
OL13--	KAPAK MBULUES LINE 1/3M	111
OL23--	KAPAK MBULUES LINE 2/3M	111
KAPAKËT MBULUES SOFT OS		
OS20--	KAPAK MBULUES SOFT 2M	114
OS24--	KAPAK MBULUES SOFT 2x2M	114
OS26--	KAPAK MBULUES SOFT 3x2M	114
OS28--	KAPAK MBULUES SOFT 4x2M	114
OS30--	KAPAK MBULUES SOFT 3M	115
OS40--	KAPAK MBULUES SOFT 4M	115
OS70--	KAPAK MBULUES SOFT 7M	116
OS71--	KAPAK MBULUES SOFT 2x7M	116
OS72--	KAPAK MBULUES SOFT 2x7M	116
OS10--	KAPAK MBULUES 1/2M	116
OS13--	KAPAK MBULUES SOFT 1/3M	116
OS23--	KAPAK MBULUES SOFT 2/3M	116
KORNIZAT E MONTIMIT NM		
NM20	KORNIZË MONTIMI ME KUNJA KAPËSE 2M	120
NM21	KORNIZË MONTIMI PA VIDA 2M	120
NM24	KORNIZË MONTIMI METALIKE ME KUNJA KAPËSE 4M	120
NM25	KORNIZË MONTIMI METALIKE PA VIDA 2M	120
NM10	KORNIZË MONTIMI ME KUNJA KAPËSE 1/2M	121
NM11	KORNIZË MONTIMI PA VIDA 1/2M	121
NM23	KORNIZË MONTIMI ME KUNJA KAPËSE 2/3M	121
NM30	KORNIZË MONTIMI ME VIDA 3M	122
NM40	KORNIZË MONTIMI ME VIDA 4M	122
NM70	KORNIZË MONTIMI ME VIDA 7M	122
NM72	KORNIZË MONTIMI ME VIDA 2x7M	122
NM32	KORNIZË MONTIMI ME VIDA 2/3M	122

KUTITË

kodi	Përshkrimi i produktit	faqe
KUTITË E RRUMBULLAKËTA		
DE10	KUTI E RRUMBULLAKËT PËR TULLË SM60-01	126
DE11	KUTI E RRUMBULLAKËT PËR TULLË TË THELLË SM60-06	126
DE30	KAPËSE E KOMBINUAR SM60-03	126
DE31	KAPËSE E KOMBINUAR SM60-04	126
DE12	KUTI E RRUMBULLAKËT PËR TULLË 65-46	127
DE13	KUTI E RRUMBULLAKËT PËR TULLË 65-60	127
DE14	PJESË SHITESË PËR MD 65-46	127
DE32	KAPËSE E KOMBINUAR MD 65-71	127
DE33	KAPËSE E KOMBINUAR MD 65-91	127
DE20	KAPAK MBROJTËS PËR KUTI 60	127
DE21	KAPAK MBROJTËS PËR KUTI 65	127
DE22	KAPAK DEKORATIV PËR KUTI SM60	127
HE10	KUTI E RRUMBULLAKËT PËR MUR BOSH SM68x40	130
HE11	KUTI E RRUMBULLAKËT PËR MUR BOSH SM68x55	130
BE10	KUTI E RRUMBULLAKËT PËR BETON 60-49	130
BE11	KUTI E RRUMBULLAKËT PËR BETON 60-77	130
BE20	KUNDËR-SUPORT KUTIE PËR BETON	130
BE21	KUTI PËR BETON PËR BLOKUES TUBI 16	130
KUTITË DREJTKËNDORE		
DM30	KUTI DREJTKËNDORE PËR TULLË PM3	134
DM31	KUTI DREJTKËNDORE PËR TULLË PM3-65	134
DM40	KUTI DREJTKËNDORE PËR TULLË PM4	134
DM41	KUTI DREJTKËNDORE PËR TULLË PM4-65	134
DM70	KUTI DREJTKËNDORE PËR TULLË PM7	135
DM71	KUTI DREJTKËNDORE PËR TULLË PM7-65	135
DM72	KUTI DREJTKËNDORE PËR TULLË PM72-65	135
DM80	PJESË DISTANCUESE PËR KUTI PM	135
DM33	KAPAK MBROJTËS PËR KUTI PM3	136
DM34	KAPAK DEKORATIV PËR KUTI PM3	136
DM43	KAPAK MBROJTËS PËR KUTI PM4	136
DM44	KAPAK DEKORATIV PËR KUTI PM4	136
DM73	KAPAK MBROJTËS PËR KUTI PM7	136
DM74	KAPAK DEKORATIV PËR KUTI PM7	136
DM75	KAPAK DEKORATIV PËR KUTI PM72	137
HM30	KUTI DREJTKËNDORE PËR MUR BOSH VM3	138
HM40	KUTI DREJTKËNDORE PËR MUR BOSH VM4	138
HM70	KUTI DREJTKËNDORE PËR MUR BOSH VM7	138
HM72	KUTI DREJTKËNDORE PËR MUR BOSH VM72	138
BM30	KUTI DREJTKËNDORE PËR BETON BM3	139
BM40	KUTI DREJTKËNDORE PËR BETON BM4	139
BM70	KUTI DREJTKËNDORE PËR BETON BM7	139
BM80	KAPËSE FIKSUESE E KOMBINUAR BM	139
BM82	PJESË DISTANCUESE PËR KUTI BM	139
KUTITË LIDHËSE		
DW10	KUTI E RRUMBULLAKËT TULLË PËR LIDHJE DSM78	142
HW10	KUTI E RRUMBULLAKËT MUR BOSH PËR LIDHJE SM78x45	142
DE23	KAPAK DEKORATIV PËR KUTI SM78	142
DE24	KAPAK MBROJTËS PËR KUTI 78	142
HW20	KUTI KATRORE TULLË PËR LIDHJE SM105x105	142
AKSESORËT E LIDHJEVE		
UW10--	BLOQE TERMINALESH ME 1 RADHË TË MBYLLURA PC 2x2,5 mm ² 10P	144
UW11--	BLOQE TERMINALESH ME 1 RADHË TË MBYLLURA PC 2x4 mm ² 10P	144
UW12--	BLOQE TERMINALESH ME 1 RADHË TË MBYLLURA PC 2x6 mm ² 10P	144
UW15--	BLOQE TERMINALESH ME 1 RADHË PA 2x2,5 mm ² 12P	144
UW16--	BLOQE TERMINALESH ME 1 RADHË TË MBYLLURA PA 2x4 mm ² 12P	144
UW17--	BLOQE TERMINALESH ME 1 RADHË TË MBYLLURA PA 2x6 mm ² 12P	144
UW29--	BLOQE TERMINALESH ME 2 RADHË PP 1,0-4,0 mm ² 12P	144
UW30--	BLOQE TERMINALESH ME 2 RADHË PP 1,5-6,0 mm ² 12P	144
UW31--	BLOQE TERMINALESH ME 2 RADHË PP 2,5-10 mm ² 12P	144
UW32--	BLOQE TERMINALESH ME 2 RADHË PP 4,0-16 mm ² 12P	144
UW25--	BLOQE TERMINALESH ME 2 RADHË PA 1,0-4,0 mm ² 12P	145
UW26--	BLOQE TERMINALESH ME 2 RADHË PA 1,5-6,0 mm ² 12P	145
UW27--	BLOQE TERMINALESH ME 2 RADHË 2,5-10 mm ² 12P	145
UW28--	BLOQE TERMINALESH ME 2 RADHË PA 4,0-16 mm ² 12P	145
UW40--	KONEKTORË PËR FUTJE TELASH PA 1,5 mm ² 3P	145
UW41--	KONEKTORË PËR FUTJE TELASH PA 1,5 mm ² 5P	145
UW42--	KONEKTORË PËR FUTJE TELASH PA 1,5 mm ² 8P	145
UW45--	KONEKTORË PËR FUTJE TELASH PA 2,5 mm ² 3P	145
UW46--	KONEKTORË PËR FUTJE TELASH PA 2,5 mm ² 4P	145
UW47--	KONEKTORË PËR FUTJE TELASH PA 2,5 mm ² 5P	145
UW50--	KONEKTORË PËR FUTJE TELASH PA 2,5 mm ² 2/1P	145

shpërndarja

LOGIQ

kodi	Përshkrimi i produktit	faqe
KUTI CUBO IP20 AC		
AC11--	KUTI NO CUBO ME KAPAK TË PASMË ANËSOR IP20 1M	148
AC21--	KUTI NO CUBO ME KAPAK TË PASMË ANËSOR IP20 2M	148
AC41--	KUTI NO CUBO ME KAPAK TË PASMË ANËSOR IP20 4M	148
AC61--	KUTI NO CUBO ME KAPAK TË PASMË ANËSOR IP20 6M	148
KUTI CUBO IP55 AQ		
AQ20--	KUTI NO CUBO IP55 2M	149
AQ22--	KUTI NO CUBO IP55 2x2M	149
AQ30--	KUTI NO CUBO IP55 3M	149
AQ21--	KUTI PO CUBO IP55 2M	150
AQ31--	KUTI PO CUBO IP55 3M	150
SISTEME KANALINASH ALUMINI MA		
RT10	PËRSHTATËS MA 162	151
RT12--	KAPAK MBULUES MA 92 2/3M	151
RT14--	KAPAK MBULUES MA 162 4M	151
RT17--	KAPAK MBULUES MA 162 7M	151
RT20--	BAZË PËR KANALINA MA 130x65	152
RT21--	BAZË PËR KANALINA MA 165x65	152
RT25--	KAPAK I PËRPARMË MA 92	152
RT30	RAFT KABLLOSH MA 43	152
RT31	RAFT KABLLOSH MA 43 AL	152
RT32	RAFT KABLLOSH MA 43 AL DYSH	152
RT35--	ELEMENT FUNDOR BLOKUES MA 130x65	153
RT36--	ELEMENT FUNDOR BLOKUES MA 165x65	153
RT38	SET PËSËSH BASHKUESE MA 65	153
RT40--	KËND UNIVERSAL MA 130x65	153
RT41--	KËND UNIVERSAL MA 165x65	153
RT42	PJESË TOKËZIMI MA 2x A6,3	153
RT43--	RAKORD L MA 130x65 / 130	153
RT44--	RAKORD L MA 165x65 / 130	154
RT47--	RAKORD L MA 165x65 / 165	154
RT45--	RAKORD T MA 130x65 / 130	154
RT46--	RAKORD T MA 165x65 / 130	154
RT48--	RAKORD T MA 165x65 / 165	154
RT50--	PLLAKËZ FIKSUESE MA NJËSHE 130x65	155
RT51--	PLLAKËZ FIKSUESE MA DYSHE 130x65	155
RT52--	KABINË SHËRBI MI MA 130x65x500	155
RT53--	KABINË SHËRBI MI MA DYSHE 130x65x500	155
KUTI DYSHEMEJE MT		
RB50	BAZË KUTIE DYSHEMEJE 4M	157
RB60	INSERT PËR KUTI SHPËRNDARJEJE PËR DYSHEME 4M	157
RB65S1	KAPAK PËR KUTI SHPËRNDARJEJE PËR DYSHEME 4M	157
RB51	BAZË KUTIE DYSHEMEJE 7M	157
RB61	INSERT PËR KUTI SHPËRNDARJEJE PËR DYSHEME 7M	157
RB66S1	KAPAK PËR KUTI SHPËRNDARJEJE PËR DYSHEME 7M	157
RB52	BAZË KUTIE DYSHEMEJE 2x7M	158
RB62	INSERT PËR KUTI SHPËRNDARJEJE PËR DYSHEME 2X7M	158
RB67S2	KAPAK PËR KUTI SHPËRNDARJEJE PËR DYSHEME 2X7M	158
RB53	BAZË KUTIE DYSHEMEJE 4x7M	158
RB62	INSERT PËR KUTI SHPËRNDARJEJE PËR DYSHEME 2X7M	158
RB68S2	KAPAK PËR KUTI SHPËRNDARJEJE PËR DYSHEME 4X7M	158
RB55S1	KUTI DYSHEMEJE ME KAPAK PËR DYSHEME DYSHE 4M	159
RB60	INSERT PËR KUTI SHPËRNDARJEJE PËR DYSHEME 4M	159
RB56S1	KUTI DYSHEMEJE ME KAPAK PËR DYSHEME DYSHE 7M	160
RB61	INSERT PËR KUTI SHPËRNDARJEJE PËR DYSHEME 7M	160
RB57S2	KUTI DYSHEMEJE ME KAPAK PËR DYSHEME DYSHE 2X7M	160
RB62	INSERT PËR KUTI SHPËRNDARJEJE PËR DYSHEME 2X7M	160
RB58S2	KUTI DYSHEMEJE ME KAPAK PËR DYSHEME DYSHE 4X7M	160
RB62	INSERT PËR KUTI SHPËRNDARJEJE PËR DYSHEME 2X7M	160
RB10	PËRSHTATËS PËR SHINË DIN 35 mm 1M	161
RB11	PËRSHTATËS PËR SHINË DIN 35 mm 2M	161

kodi	Përshkrimi i produktit	faqe
ÇELËSAT SQ		
SQ10--XO	ÇELËS ME 1 DREJTIM 10 AX 250 V-	174
SQ10--INXO	ÇELËS ME 1 DREJTIM 10 AX 250 V- __ IN	174
SQ11--XO	BUTON ME SHTYPJE ME 1 DREJTIM 10 A 250 V-	174
SQ11--IN01XO	BUTON ME SHTYPJE ME 1 DREJTIM 10 A 250 V- __ IN 01	174
SQ11--IN02XO	BUTON ME SHTYPJE ME 1 DREJTIM 10 A 250 V- __ IN 02	175
SQ22--IN03XO	ÇELËS 2-POLAR 16 AX 250 V- __ IN 03	175
SQ50--XO	ÇELËS ME 2 VENDE - 1 DREJTIM 10 AX 250 V-	175
SQ51--XO	BUTON ME SHTYPJE ME 2 VENDE - 1 DREJTIM 10 A 250 V-	175
SQ52--NT09XO	MBYLLËSE ÇELËSI 10 AX 250 V- __ NT 09	175
SQ53--NT09XO	MBYLLËSE BUTONI ME SHTYPJE 10 A 250 V- __ NT 09	175
SQ60--XO	ÇELËS ME 2 DREJTIME 10 AX 250 V-	175
SQ63--XO	ÇELËS DYSH ME 2 DREJTIME 10 AX 250 V-	176
SQ70--XO	ÇELËS NDËRMJETËS 10 AX 250 V-	176
SINJALIZIMI IA		
IA10--	LLAMBË NEONI 230 V- 0,34 W	177
IA20--	SINJALIZIMI LED 230 V- AC/DC 0,4 W	177
IA21--	SINJALIZIMI LED 24 V AC/DC 0,2W	177
IA22--	SINJALIZIMI LED 12 V AC/DC 0,1W	177
PRIZAT VQ		
VQ10--XO	PRIZË SCHUKO 2P+E 16 A 250 V- __ XO	180
VQ11--XO	PRIZË SCHUKO+KAPAK 2P+E 16 A 250 V- __ XO	180
VQ12--XO	PRIZË SCHUKO 2P+E 16 A 250 V- BV __ XO	180
VQ13--XO	PRIZË SCHUKO+KAPAK 2P+E 16 A 250 V- BV __ XO	180
VQ16--	PRIZË SCHUKO DYSHE 2P+E 16 A 250 V-	180
VQ40--XO	PRIZË FRANCEZE 2P+E 16 A 250 V- __ XO	181
VQ41--XO	PRIZË FRANCEZE+KAPAK 2P+E 16 A 250 V- __ XO	181
VQ42--XO	PRIZË FRANCEZE 2P+E 16 A 250 V- BV __ XO	181
VQ43--XO	PRIZË FRANCEZE+KAPAK 2P+E 16 A 250 V- BV __ XO	181
VQ46--XO	PRIZË FRANCEZE DYSHE 2P+E 16 A 250 V-	181
KOMUNIKIMET KQ		
KQ10--XO	PRIZË TV BAZË 0 dB	182
KQ11--XO	PRIZË TV-R ME KAPAK FUNDOR 1 dB	182
KQ12--XO	PRIZË TV-R KALUESE 10 dB	182
KQ16--XO	PRIZË SAT-TV-R ME KAPAK FUNDOR 3 dB	182
KQ22--XO	PRIZË AUDIO 2xRCA	183
KQ23--XO	PRIZË AUDIO PËR ALTOPARLANTË	183
KQ36--XO	PRIZË TEL KS RJ11 6/4	183
KQ37--XO	PRIZË CAT5e KS RJ45 8/8	183
KQ38--XO	PRIZË TEL KS DYSHE 2x RJ11 6/4	183
KQ39--XO	PRIZË CAT5e KS DYSHE 2x RJ45 8/8	183
KQ35--XO	PRIZË TEL LT RJ11 6/4	183
KQ40--XO	PRIZË CAT6s KS DYSHE 2x RJ45 8/8 E HOLLË	184
KQ41--XO	PRIZË CAT6s KS DYSHE 2x RJ45 8/8 E HOLLË	184
LIDHJET ELEKTRONIKE EQ		
EQ15--XO	REOSTAT RROTULLUES ME 2 DREJTIME RL 400 W	185
EQ16--XO	REOSTAT RROTULLUES ME 2 DREJTIME RLC 400 W	185
EQ19--XO	REOSTAT RROTULLUES ME 2 DREJTIME LED 100 W	185
EQ32--XO	ÇELËS IR 5 A 230 V-	187
EQ35--XO	TERMOSTAT PËR NGROHJE 10 A 230 V-	187
EQ36--XO	TERMOSTAT PËR NGROHJE/FTOHJE 5 A 230V-	187
EQ37--XO	NGROHJE ME TERMOSTAT NGA DYSHEMEJA 16 A 230 V-	188
EQ68--XO	NJËSI USB E FURNIZIMIT ME ENERGI 5 V 3,0 A	188
KAPAKËT PQ		
PQ10--XO	TAPË	189
PQ30--	KAPAK TAE/TDO	189
RRETHUESE OQ		
OQ10--	KAPAK MBULUES LOGIQ 1	190
OQ20--	KAPAK MBULUES LOGIQ 2	190
OQ30--	KAPAK MBULUES LOGIQ 3	191
OQ40--	KAPAK MBULUES LOGIQ 4	191
OQ50--	KAPAK MBULUES LOGIQ 5	191

ekonomik

kodi	Përshkrimi i produktit	faqe	kodi	Përshkrimi i produktit	faqe
ÇELËSAT SE			KAPAKËT PE		
SE10	ÇELËS ME 1 DREJTIM 10 AX 250 V-	202	PE10--	KAPAK TV-R 2P/3P	218
SE11	BUTON ME SHYTPJE ME 1 DREJTIM 10 A 250 V-	202	PE20--	KAPAK KS NJËSH	218
SE22	ÇELËS 2-POLAR 16 AX 250 V-	202	PE21--	KAPAK KS DYSH	218
SE50	ÇELËS ME 2 VENDE - 1 DREJTIM 10 AX 250 V-	202	PE30--	KAPAK TAE/TDO	218
SE51	BUTON ME SHYTPJE ME 2 VENDE - 1 DREJTIM 10 A 250 V-	203	LIDHJET ELEKTRONIKE EE		
SE52	MBYLLËSE ÇELËSI 10 AX 250 V-	203	EE15	REOSTAT RROTULLUES ME 2 DREJTIME RL 400 W	219
SE53	MBYLLËSE BUTONI ME SHYTPJE 10 A 250 V-	203	EE16	REOSTAT RROTULLUES ME 2 DREJTIME RLC 400 W	219
SE60	ÇELËS ME 2 DREJTIME 10 AX 250 V-	203	EE19	REOSTAT RROTULLUES ME 2 DREJTIME LED 100 W	220
SE63	ÇELËS DYSH ME 2 DREJTIME 10 AX 250 V-	203	EE32	ÇELËS IR 5 A 230 V-	220
SE70	ÇELËS NDËRMJETËS 10 AX 250 V-	203	EE67	NJËSI USB E FURNIZIMIT ME ENERGJI 5 V 2,4 A	220
SE10--	ÇELËS ME 1 DREJTIM 10 AX 250 V-	204	EE15--	REOSTAT RROTULLUES ME 2 DREJTIME RL 400 W	221
SE10--IN	ÇELËS ME 1 DREJTIM 10 AX 250 V- IN	204	EE16--	REOSTAT RROTULLUES ME 2 DREJTIME RLC 400 W	221
SE11--	BUTON ME SHYTPJE ME 1 DREJTIM 10 A 250 V-	204	EE19--	REOSTAT RROTULLUES ME 2 DREJTIME LED 100 W	221
SE11--TI50	BUTON ME SHYTPJE ME 1 DREJTIM 10 A 250 V- TI 50	204	EE32--	ÇELËS IR 5 A 230 V-	221
SE11--TI51	BUTON ME SHYTPJE ME 1 DREJTIM 10 A 250 V- TI 51	204	EE67--	NJËSI USB E FURNIZIMIT ME ENERGJI 5 V 2,4 A	222
SE11--IL	BUTON ME SHYTPJE ME 1 DREJTIM 10 A 250 V- IL	204	KAPAK ELEKTRONIK PE		
SE22--IN03	ÇELËS 2-POLAR 16 AX 250 V- IN 03	204	PE41--	REOSTAT ME KAPAK Ø6	224
SE50--	ÇELËS ME 2 VENDE - 1 DREJTIM 10 AX 250 V-	205	PE32--	ÇELËS IR ME KAPAK	224
SE51--	BUTON ME SHYTPJE ME 2 VENDE - 1 DREJTIM 10 A 250 V-	205	PE67--	KAPAK PËR NJËSINË USB TË FURNIZIMIT ME ENERGJI	224
SE52--NT09	MBYLLËSE ÇELËSI 10 AX 250 V- NT 09	205	AKSESORËT AE		
SE53--NT09	MBYLLËSE BUTONI ME SHYTPJE 10 A 250 V- NT 09	205	AE10--	TAPË	225
SE60--	ÇELËS ME 2 DREJTIME 10 AX 250 V-	205	AE20--	KUTI LIDHJEJE 5-POLARE 3P+N+E 5x4mm2	225
SE63--	ÇELËS DYSH ME 2 DREJTIME 10 AX 250 V-	205	AE30--	KUTI ME MONTIM NË SIPËRFAQE 1	225
SE70--	ÇELËS NDËRMJETËS 10 AX 250 V-	205	AE31--	KUTI ME MONTIM NË SIPËRFAQE PËR PRIZË DYSHE EKONOMIK	225
BUTONAT TE			AE50--	MBROJTJE PËR MURIN	226
TE10--	BUTON ME 1 VEND	206	AE51--	MBROJTJE PËR FËMIJËT KS	226
TE10--IN	TREGUES BUTONI	206	RRETHUESE OE		
TE13--IL	BUTON ME KAPAK ME MBISHKRIM IL	206	OE10--	RRETHUES EKONOMIK 1	227
TE11--	BUTON ME 2 VENDE	206	OE20--	RRETHUES EKONOMIK 2 HORIZONTAL	227
SINJALIZIMI IA			OE21--	RRETHUES EKONOMIK 2 VERTIKAL	227
IA10--	LLAMBË NEONI 230 V- 0,34 W	207	OE30--	RRETHUES EKONOMIK 3 HORIZONTAL	227
IA20--	SINJALIZIMI LED 230 V- AC/DC 0,4 W	207	OE31--	RRETHUES EKONOMIK 3 VERTIKAL	228
IA21--	SINJALIZIMI LED 24 V AC/DC 0,2W	207	OE40--	RRETHUES EKONOMIK 4 HORIZONTAL	228
IA22--	SINJALIZIMI LED 12 V AC/DC 0,1W	207	OE41--	RRETHUES EKONOMIK 4 VERTIKAL	228
PRIZAT VE			OE50--	RRETHUES EKONOMIK 5 HORIZONTAL	228
VE10--XO	PRIZË SCHUKO 2P+E 16 A 250 V- XO	210	OE90--	KORNIZA DEKORATIVE ME NGJYRA	229
VE11--XO	PRIZË SCHUKO+KAPAK 2P+E 16 A 250 V- XO	210	fontana		
VE12--XO	PRIZË SCHUKO 2P+E 16 A 250 V- BV XO	210	kodi	Përshkrimi i produktit	faqe
VE13--XO	PRIZË SCHUKO+POKROV 2P+E 16 A 250 V- BV XO	210	ÇELËSAT SF		
VE10--	PRIZË SCHUKO 2P+E 16 A 250 V-	210	SF10--	ÇELËS ME 1 DREJTIM IP44 10 AX 250 V-	232
VE11--	PRIZË SCHUKO+KAPAK 2P+E 16 A 250 V-	210	SF10--TI	ÇELËS ME 1 DREJTIM IP44 10 AX 250 V- TI	232
VE12--	PRIZË SCHUKO 2P+E 16 A 250 V- BV	210	SF11--TI	BUTON ME SHYTPJE ME 1 DREJTIM IP44 10 A 250 V- TI	232
VE13--	PRIZË SCHUKO+KAPAK 2P+E 16 A 250 V- BV	210	SF20--	ÇELËS 2-POLAR IP44 10 AX 250 V-	232
VE40--XO	PRIZË FRANCEZE 2P+E 16 A 250 V- XO	211	SF50--	ÇELËS ME 2 VENDE ME 1 DREJTIM IP44 10 AX 250 V-	233
VE41--XO	PRIZË FRANCEZE+KAPAK 2P+E 16 A 250 V- XO	211	SF51--	BUTON ME SHYTPJE ME 2 VENDE ME 1 DREJTIM IP44 10 A 250 V-	233
VE42--XO	PRIZË FRANCEZE 2P+E 16 A 250 V- BV XO	211	SF60--	ÇELËS ME 2 DREJTIME IP44 10 AX 250 V-	233
VE43--XO	PRIZË FRANCEZE+KAPAK 2P+E 16 A 250 V- BV XO	211	SF60--TI	ÇELËS ME 2 DREJTIME IP44 10 AX 250 V- TI	233
VE40--	PRIZË FRANCEZE 2P+E 16 A 250 V-	211	SF63--	ÇELËS DYSH ME 2 DREJTIME 10 AX 250 V-	233
VE41--	PRIZË FRANCEZE+KAPAK 2P+E 16 A 250 V-	211	SF70--	ÇELËS NDËRMJETËS IP44 10 AX 250 V-	233
VE42--	PRIZË FRANCEZE 2P+E 16 A 250 V- BV	211	PRIZAT VF		
VE43--	PRIZË FRANCEZE+KAPAK 2P+E 16 A 250 V- BV	211	VF10--	PRIZË SCHUKO+KAPAK IP44 2P+E 16 A 250 V-	234
VE16--	PRIZË SCHUKO DYSHE 2P+E 16 A 250 V-	212	VF12--	PRIZË SCHUKO+KAPAK IP44 2P+E 16 A 250 V- BV	234
VE46--	PRIZË FRANCEZE DYSHE 2P+E 16 A 250 V-	212	SETET CF		
VE30--	PRIZË 2P 16 A 250 V-	212	CF10--	SET PRIZASH SCHUKO DYSHE HORIZONTALE IP44 2x2P+E 16 A 250 V-	235
KOMUNIKIMET KE			CF11--	SET PRIZASH SCHUKO DYSHE VERTIKALE IP44 2x2P+E 16 A 250 V-	235
KE11	PRIZË TV-R ME KAPAK FUNDOR 1 dB	213	CF12--	PRIZË SCH+SET ÇELËSASH ME 2 DREJTIME HORIZONTALE IP44 16 A + 10 AX 250 V-	235
KE12	PRIZË TV-R KALUESE 10 dB	213	CF13--	PRIZË SCH+SET ÇELËSASH ME 2 DREJTIME VERTIKALE IP44 16 A + 10 AX 250 V-	236
KE16	PRIZË SAT-TV-R ME KAPAK FUNDOR 3 dB	213	CF14--	SET PRIZASH SCHUKO DYSHE HORIZONTALE IP44 2x 2P+E 16 A 250 V-BV	236
KE36	PRIZË TEL KS RJ11 6/4	213	CF15--	SET PRIZASH SCHUKO DYSHE VERTIKALE IP44 2x 2P+E 16 A 250 V- BV	236
KE37	PRIZË CAT5e KS RJ45 8/8	214	CF16--	PRIZË SCH+SET ÇELËSASH ME 2 DREJTIME HORIZONTALE IP44 16 A + 10 AX 250 V- BV	236
KE40	PRIZË CAT6s KS RJ45 8/8 E HOLLË	214	CF17--	PRIZË SCH+SET ÇELËS ME 2 DREJTIME VERTIKALE IP44 16 A + 10 AX 250 V- BV	236
KE38	PRIZË TEL KS DYSHE 2x RJ11 6/4	214	AKSESORËT AF		
KE39	PRIZË CAT5e KS DYSHE 2x RJ45 8/8	214	AF10--	KUTI SHPËRNDARJEJE IP44 RN01	237
KE41	PRIZË CAT6s KS DYSHE 2x RJ45 8/8 E HOLLË	214	AF20--	KUTI SHPËRNDARJEJE IP55 ND01	237
KE45	PËRSHTATËS KS NJËSH	214			
KE46	PËRSHTATËS KS DYSH	215			
KE47	PËRSHTATËS PD DYSH	215			
KE10--	PRIZË TV BAZË 0 dB	216			
KE11--	PRIZË TV-R ME KAPAK FUNDOR 1 dB	216			
KE12--	PRIZË TV-R KALUESE 10 dB	216			
KE16--	PRIZË SAT-TV-R ME KAPAK FUNDOR 3 dB	216			
KE22--	PRIZË AUDIO 2xRCA	216			
KE23--	PRIZË AUDIO PËR ALTOPARLANTË	216			
KE36--	PRIZË TEL KS RJ11 6/4	216			
KE37--	PRIZË CAT5e KS RJ45 8/8	217			
KE40--	PRIZË CAT6s KS RJ45 8/8 E HOLLË	217			
KE38--	PRIZË TEL KS DYSHE 2x RJ11 6/4	217			
KE39--	PRIZË CAT5e KS DYSHE 2x RJ45 8/8	217			
KE41--	PRIZË CAT6s KS DYSHE 2x RJ45 8/8 E HOLLË	217			
KE35--	PRIZË TEL LT RJ11 6/4	217			



TEM

On | Off and everything in between

100% ELEKTRISCH

www.tem.si

TEM

On|Off and everything in between



www



TEM

TEM ČATEŽ d.o.o.
Čatež 13, 8212 VELIKA LOKA
SLOVENIJA
tem@tem.si
www.tem.si

T +386(0)7 348 99 00

TEM

AL

www.tem.si

